



MSCPH506

M. Sc. IInd Semester
Condensed Matter Physics



DEPARTMENT OF PHYSICS
SCHOOL OF SCIENCES
UTTARAKHAND OPEN UNIVERSITY

Board of Studies

Prof. P. D. Pant
Director School of Sciences
Uttarakhand Open University, Haldwani
Prof. P. S. Bisht,
SSJ Campus, Kumaun University, Almora.
Dr. Kamal Deolal
Department of Physics
School of Sciences, Uttarakhand Open University

Prof. S.R. Jha,
School of Sciences, I.G.N.O.U., Maidan Garhi,
New Delhi
Prof. R. C. Shrivastva,
Professor and Head, Department of Physics, CBSH,
G.B.P.U.A.&T. Pantnagar, India

Department of Physics (School of Sciences)

Dr. Kamal Devlal (Assistant Professor)
Dr. Vishal Sharma (Assistant Professor)
Dr. Gauri Negi (Assistant Professor)

Dr. Meenakshi Rana (Assistant Professor (AC))
Dr. Rajesh Mathpal (Assistant Professor (AC))

Unit writing and Editing

Editing

Prof. Madan Singh
National University of Lesotho
Southern Africa

Writing

1. Dr. Kamal Devlal
Assistant Professor
Department of Physics
School of Sciences, Uttarakhand Open University

2. Dr. Meenakshi Rana
Assistant Professor (AC)
Department of Physics
School of Sciences, Uttarakhand Open University

Course Title and Code	: Condensed Matter Physics (MSCPH 506)
ISBN	:
Copyright	: Uttarakhand Open University
Edition	: 2022
Published By	: Uttarakhand Open University, Haldwani, Nainital- 263139
Printed By	:

MSCPH506

Condensed Matter Physics



**DEPARTMENT OF PHYSICS
SCHOOL OF SCIENCES
UTTARAKHAND OPEN UNIVERSITY**

Phone No. 05946-261122, 261123

Toll free No. 18001804025

Fax No. 05946-264232, E. mail info@uou.ac.in

<http://uou.ac.in>

Contents

Course: Condensed Matter Physics

Course code: MSCPH506

Credit: 3

Unit number	Block and Unit title	Page number
BLOCK-I		
1	Crystal Structure	1-37
2	Crystal diffraction	38-60
3	Crystal binding	61-82
4	Imperfection in crystals	83-99
BLOCK-II		
5	Crystal vibrations	100-116
6	Thermal properties of Solids	117-141
7	Free electron theory	142-171
8	Band Theory of Solids	172-194
9	Semiconductor Solids	195-223
BLOCK-III		
10	Dielectrics	224-255
11	Plasma optics	256-274
12	Diamagnetism and Paramagnetism	275-299
13	Ferromagnetism	300-327
14	Superconductivity	328-349

UNIT 1

CRYSTAL STRUCTURE

Structure

- 1.1 Introduction
- 1.2 Objective
- 1.3 Crystalline and amorphous solids
- 1.4 Crystal structure
 - 1.4.1 Lattice
 - 1.4.2 Lattice translational vector
 - 1.4.3 Primitive vector
 - 1.4.4 Basis
 - 1.4.5 Crystal lattice
 - 1.4.6 Unit cell and primitive cell
- 1.5 Types of lattices
 - 1.5.1 Two dimensional lattice type
 - 1.5.2 Three dimensional type crystal system
- 1.6 cubic crystal systems
 - 1.6.1 Simple cubic crystal (sc)
 - 1.6.2 Body centered cubic crystal (bcc)
 - 1.6.3 Face centered cubic crystal (fcc)
- 1.7 Crystal symmetry and symmetry operation
 - 1.7.1 Translational symmetry
 - 1.7.2 Rotational symmetry
 - 1.7.3 Reflections
 - 1.7.4 Inversion
- 1.8 Crystal direction and planes
 - 1.8.1 Miller Indices
 - 1.8.2 Inter planer separation
- 1.9 Crystal structure
- 1.10 Wigner Seitz cell
- 1.11 Quasi crystals
- 1.12 Liquid crystals
- 1.13 Summary
- 1. 14 Glossary
- 1.15 References
- 1.16 Suggested readings
- 1.17 Terminal questions

1.1 INTRODUCTION

The branch of physics which deal with the properties of solids materials is known as solid state Physics. We are living in the world of material and maximum are in solid form. Many things are used by human society, are made of different types of solid material. Properties like strength, modulus, electrical, thermal and chemical properties of solid material depend on its atomic and molecular structure. To study materials or solid, first we have to understand the structure of solid material. The study of solids and its properties started after the X-ray diffraction by Crystal in 1912. Previously, solid state Physics concerned with crystalline solids and its properties. Later on the study of solids and materials has been extended, and many new materials like nanocrystalline, amorphous, glasses, liquid crystals polymer, composite materials and many other new materials are included in this Branch. This new wider field is known as Condensed Matter Physics. It is a new and largest area of Physics which is useful to understand the nature of matters range from fundamental particle to matter in Universe.

1.2 OBJECTIVE

After reading this unit we will able to understand:

1. Crystalline and amorphous and other type of solids
2. Different types of crystal structure
3. Lattice and lattice types
4. Symmetry and symmetry operation
5. Crystal directions, crystal planes and Miller Indices
- 5 Structure of different solid
6. Quasi crystals
7. Liquid crystals

1.3 CRYSTALLINE AND AMORPHOUS SOLID

In solids, the structure refers the arrangement of its components on that solid material. It could be on length scale (atomic, micro, macro on nano scale) and all length scales are significant. On the basis of structure, the solids can be classified in two broad categories crystalline and amorphous.

1.3.1 Crystalline Solid

A crystal or crystalline solid is formed by regular repetition of its building blocks (atoms or molecule) in a three dimensional periodic array. Thus a crystal is formed by adding atoms or molecules in constant environment. The common examples of crystals are table salt (NaCl), diamond, snowflakes, metals, ice, ceramics etc. Crystal can be considered a material in which constituent are arranged in a highly ordered microscope structure in space up to long range. In actual case, crystalline solid is composed of a bunch of large number of small crystal grains. These

grains are arranged in a random manner and joint to each other at certain boundaries called grain boundaries. Such crystalline solids are called polycrystal.

Further, if constituents of crystal are arranged in a regular manner up to a large scale size in macroscopic range ($\approx 1\text{mm}$ order) such crystal specimen is called single crystal. An ideal crystal is a single crystal with a perfectly regular long range ordered arrangement of constituent which has no impurity and no defects. A single crystal gives the maximum information about the properties of such crystalline material. Therefore, single crystal is being studied more. The experimental evidence of long range periodicity in a crystalline solid was first confirmed in 1912 by x-ray diffraction experiment. The branch which deals with the study of crystalline solids is often known as crystallography.

1.3.2 Amorphous solid

Amorphous solids are those materials in which constituents (atoms or molecules) are not arranged in a regular manner over a long range. There is no periodicity in structure, if periodicity occurs, it must be over a short distance of the order of several angstrom. The examples of crystalline solid are glass, plastic, rubber etc. Figure 1.1 shows arrangement of atoms or molecules in crystalline and amorphous solids.

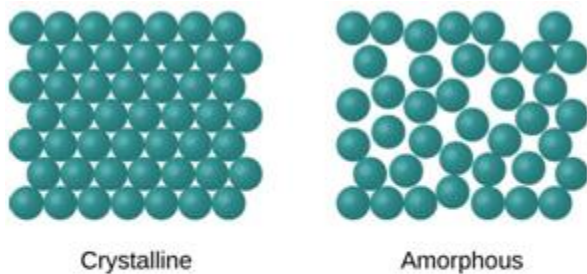

Figure 1.1: crystalline and amorphous solids

1.4 CRYSTAL STRUCTURE

Following terms are used in the study of crystal and other solids.

1.4.1 Lattice

Lattice is defined as a regular periodic array of point in space. Each point in a lattice has identical surrounding everywhere. Lattice is basically imaginary points on space with a periodic manner. Lattice points in two dimensional and three dimensions are shown in figure 1.2 and 1.3.

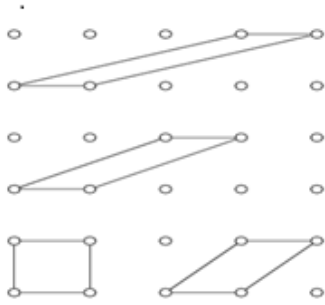

Figure 1.2 Lattice points in two dimensions

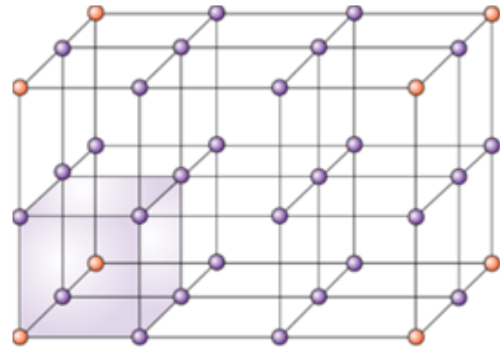

Figure 1.3 Lattice points in three dimensions

1.4.2 Basis

The term basis is used for atoms or molecules which are constituents of a crystal material. For example in NaCl crystal, NaCl molecule, group of one sodium and one chlorine atoms form basis as shown in Figure 1.4.

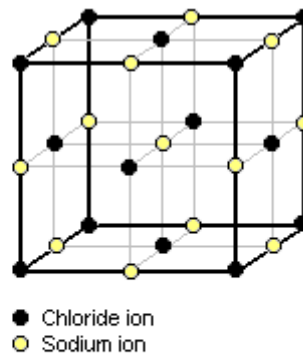

Figure 1.4 NaCl basis (one Na and one Cl) in crystal

1.4.3 Crystal Structure

Logically a crystal structure is given as:

Crystal structure = lattice + basis

Therefore, on placing bases on the lattice point in space we will obtain a crystal structure as shown in figure 1.5.

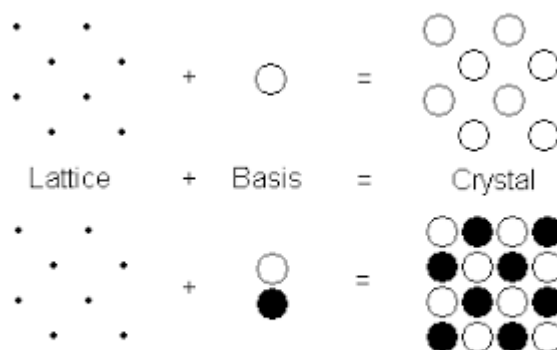

Figure 1.5: Crystal as combination of lattice and basis.

1.4.4: Lattice Translation Vectors

The lattice is defined by three fundamental vectors $\mathbf{a}_1, \mathbf{a}_2, \mathbf{a}_3$ in such a way that all the lattice points in the crystal can be denoted by using these vectors. Inside the crystal, basis (atoms or molecules) arrangement looks same everywhere with respect to any points. Any lattice point can be expressed by a position vector \mathbf{r} as

$$\mathbf{r} = n_1 \mathbf{a}_1 + n_2 \mathbf{a}_2 + n_3 \mathbf{a}_3$$

Where n_1, n_2, n_3 are integer numbers. Similarly any another lattice point \mathbf{r}' in the crystal can be obtained by

$$\mathbf{r}' = \mathbf{r} + n_1 \mathbf{a}_1 + n_2 \mathbf{a}_2 + n_3 \mathbf{a}_3$$

Thus any point in the lattice can be translated to another point by using suitable integers n_1, n_2, n_3 as shown in figure 1.6. The lattice translation vector \mathbf{T} is a vector, which can connect any two lattice points, and \mathbf{T} can be given as

$$\mathbf{T} = n \mathbf{a}_1 + l \mathbf{a}_2 + m \mathbf{a}_3$$

Where n, l, m are again suitable integer numbers. This vector is useful to understand the nature and shape of lattice.

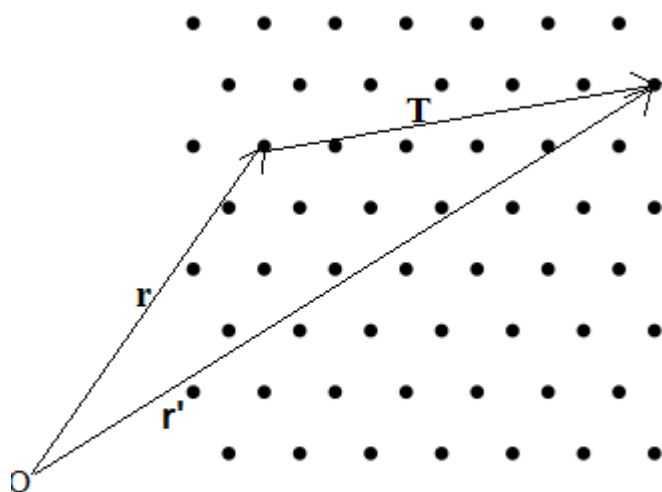

Figure 1.6: lattice translation vector T

1.4.5: Primitive Lattice Vector and primitive cell

Primitive vectors define the smallest volume cell of crystal. We often use primitive lattice vectors to define the axis of crystal. Lattice translation vectors $\mathbf{a}_1, \mathbf{a}_2, \mathbf{a}_3$ are said to be primitive vectors if these vectors form three adjacent edges of parallelepiped of smallest volume. This parallelepiped is called primitive cell. There is always one lattice point in a primitive cell. For example, if a primitive cell is cubic, with eight lattice points at its corners, then each points are shared by eight neighbor cubes and net point in such primitive cell is $1/8 \times 8 = 1$. Then the edges of this cube give primitive vectors.

1.4.6: Unit cell

For describing crystal structure, it is convenient to divide the crystal into small entities such small group of atoms or molecules is a well defined arrangement. These small cells are called unit cells. The unit cells are building blocks for construction of complete crystal structure. In three dimensional lattices, the unit cells are generally parallelepiped. A unit cell can be completely described by three vectors $\mathbf{a}_1, \mathbf{a}_2, \mathbf{a}_3$ called lattice vectors. The interfacing angle between lattice vectors are generally α, β, γ . On the basis of lattice vectors $\mathbf{a}_1, \mathbf{a}_2, \mathbf{a}_3$ and interfacing angles α, β, γ different types of unit cell are determined as shown in figure 1.7. For example, if lattice vectors $\mathbf{a}_1, \mathbf{a}_2, \mathbf{a}_3$ are equal and angles α, β, γ are 90° degree, the unit cell will be cubic type. Bravis showed that there are total 14 types of space lattice possible on the condition of lattice vectors $\mathbf{a}_1, \mathbf{a}_2, \mathbf{a}_3$ and interfacing angles α, β, γ .

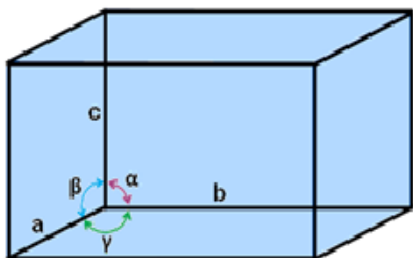

Figure 1.7: lattice parameter of unit cell

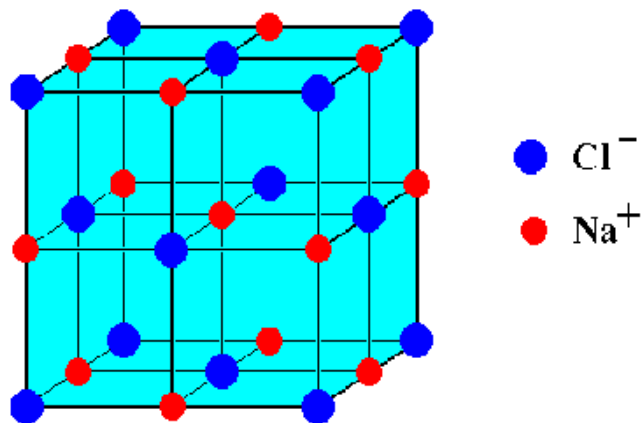

Figure 1.8 :Unit cell and primitive cell of NaCl

1.4.6 Difference between Unit Cell and Primitive Cell

Unit cell and primitive cell, both are building blocks for a crystal structure. The difference is, the primitive cell always contains lattice points only at corners. But in case of unit cell, the lattice points may be at corners, or at edges or at surfaces. For example, NaCl crystal is face centered cubic as shown in figure 1.8. The volume of a unit cell is a^3 but the volume of primitive cell is $a^3/4$. It means four primitive cells are contained in a unit cell. The detail of NaCl structure will be discussed later on. In some cases, primitive cell is same as unit but not always. Thus we can summarize that unit cell may be primitive but all the primitive cells are not always unit cell.

1.5 TYPES OF CRYSTAL LATTICE

In a perfect crystal, there is a regular arrangement of atoms or molecules. The periodicity is maintained in all directions. Now can classified the lattice structure into two cases as two dimensional and three dimensional.

1.5.1 Two Dimensional Lattice Type

Crystal lattice can be mapped into them self by lattice translational vector T . Symmetric operation can be used to map the crystal lattice into them self. Symmetric operation is an operation, after which the Crystal is mapped into itself. There is no variation in arrangement of lattice point. In case of two dimension lattice, there is unlimited number of ways for defining the lattice points because there is no restriction on the length of crystal. If \mathbf{a}_1 and \mathbf{a}_2 are lattice vectors in two dimensional crystal as shown in figure 1.9. The lattice vectors \mathbf{a}_1 and \mathbf{a}_2 can be chosen by different ways as shown in figure.

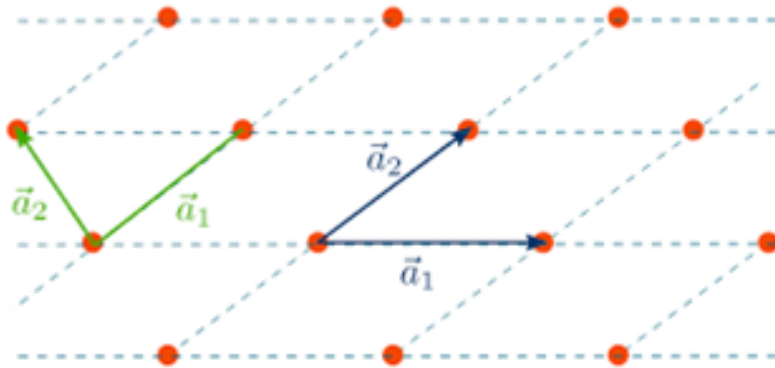

Figure 1.9: Two dimensional lattice vectors

We can choose any arbitrary point as origin and consider two lattice vectors for defining any point. The simplest translational T can be given as

$$T = na_1 + ma_2$$

Where n and m are integer numbers depends on the position of any point. Based on the possibility and restrictions, there are five distinct type of lattice in two dimensions as shown in figure 1.10. These lattice types are called Bravais lattice.

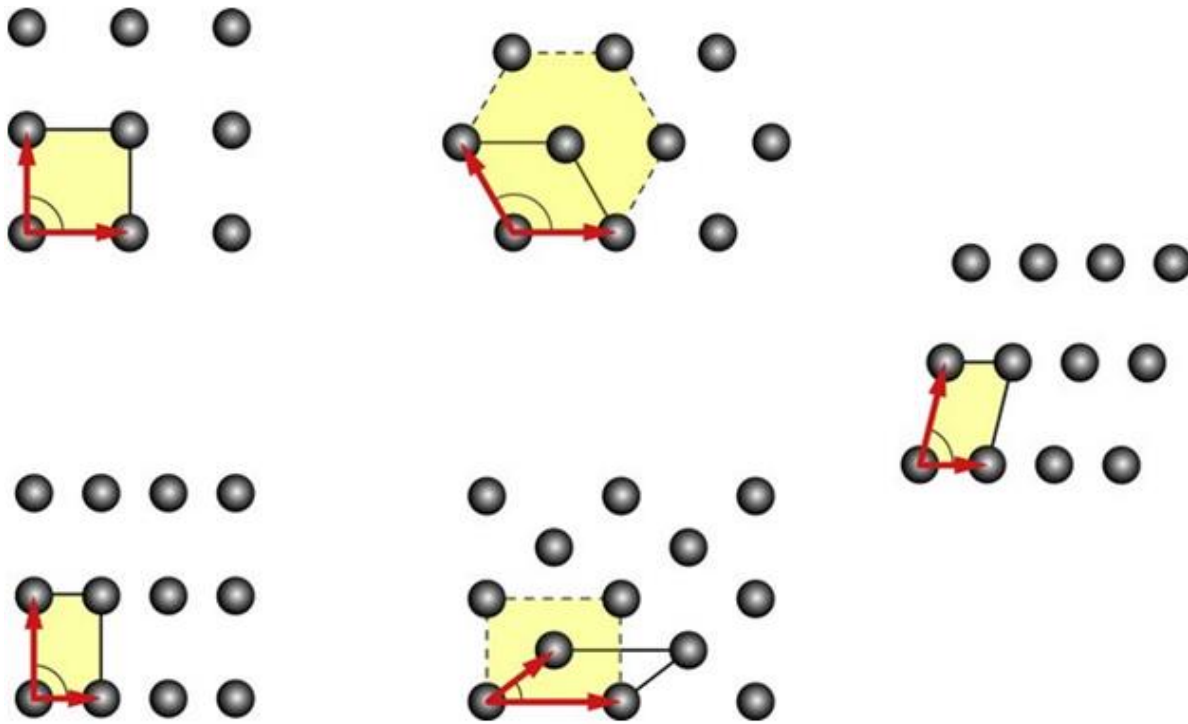

Figure 1.10: Five distinct types of Bravais lattice (square, Hexagonal, rectangular, centered rectangular, and oblique).

1.5.2 Three Dimensional Lattice Types

In general practice crystal system are divided into seven groups or seven types crystal system based on condition of lattice three vectors $\mathbf{a}_1, \mathbf{a}_2, \mathbf{a}_3$ and three interfacing angles α, β, γ between them. The seven types of Crystal system which contains total 14 types of lattice are listed in table 1. The 7 types of crystal system are named as cubic, tetragonal, orthorhombic, monoclinic, triclinic, triangular (rhombohedral) and hexagonal. The simplest crystal system in three dimensional space is cubic, which has three types of lattice structure named as simple cubic (sc), body centered cubic (bcc) and face centered cubic (fcc). For better understanding we will study the cubic crystal in detail. Similarly, we have other types of crystal structure. All 14 types of crystal lattice under seven types of Crystal system are given in figure 1.11.

Table I: 14 types of crystal lattice under seven types of Crystal system

Crystal System	Number of Lattice	Lattice types	Restriction on lattice parameters	Lattice symbol	Examples
Cubic	3	Simple Cubic (sc)	$a_1 = a_2 = a_3$	P	<i>Cu, Ag, Fe,</i>
		Body centered cubic (bcc)	$\alpha = \beta = \gamma = 90^\circ$	I	<i>NaCl</i>
		Face centered cubic (fcc)		F	
Tetragonal	2	Simple tetragonal (st)	$a_1 = a_2 \neq a_3$	P	β - <i>Sn, TiO₂</i>
		Body centered tetragonal (bct)	$\alpha = \beta = \gamma = 90^\circ$	I	
Orthorhombic	4	Simple	$a_1 \neq a_2 \neq a_3$	P	<i>Ga, Fe₃C</i>
		Body centered	$\alpha = \beta = \gamma = 90^\circ$	I	
		Face centered		F	
		End centered		C	
Monoclinic	2	Simple	$a_1 \neq a_2 \neq a_3$	P	
		End centered	$\alpha = \gamma = 90^\circ \neq \beta$	C	
Triclinic	1	Simple	$a_1 \neq a_2 \neq a_3$ $\alpha \neq \beta \neq \gamma$	P	<i>Kr₃Cr₂O₇</i>
Trigonal (Rhombohedral)	1	Simple	$a_1 = a_2 = a_3$ $\alpha = \beta = \gamma < 120^\circ$ $\neq 90^\circ$	P	<i>As, Bs</i>
Hexagonal	1	Simple	$a_1 = a_2 \neq a_3$ $\alpha = \beta = 90^\circ$ $\gamma = 120^\circ$	P	<i>Zn, Mg</i>

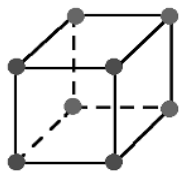

simple cubic

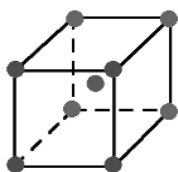

body-centered
cubic

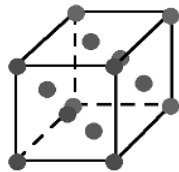

face-centered
cubic

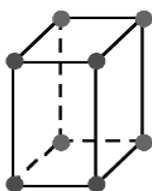

simple
tetragonal

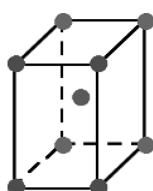

body-centered
tetragonal

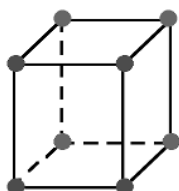

simple
orthorhombic

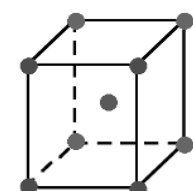

body-centered
orthorhombic

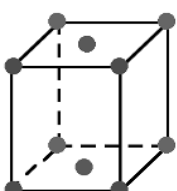

base-centered
orthorhombic

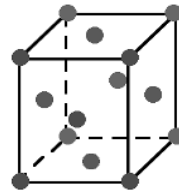

face-centered
orthorhombic

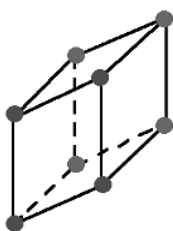

rhombohedral

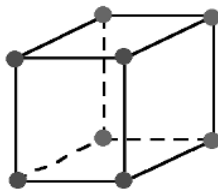

hexagonal

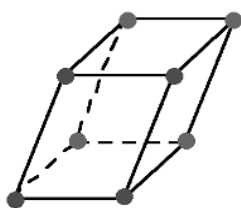

simple
monoclinic

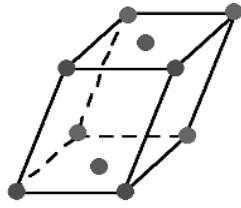

base-centered
monoclinic

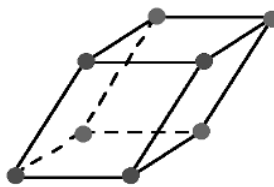

triclinic

Figure 1.11 Seven types Crystal System (14 types lattice)

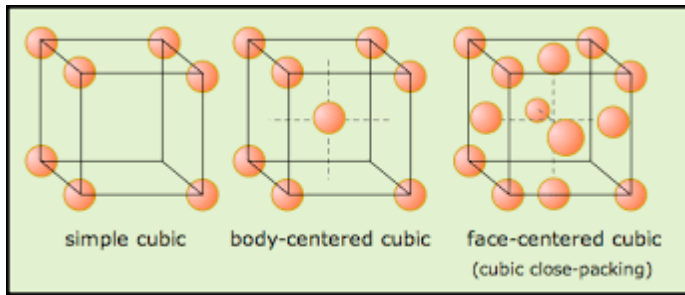

Figure 1.11.1 Cubic Crystal System.

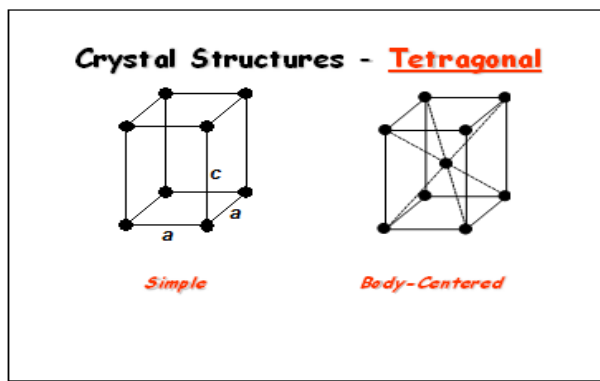

Figure 1.11.2 Tetragonal Crystal System.

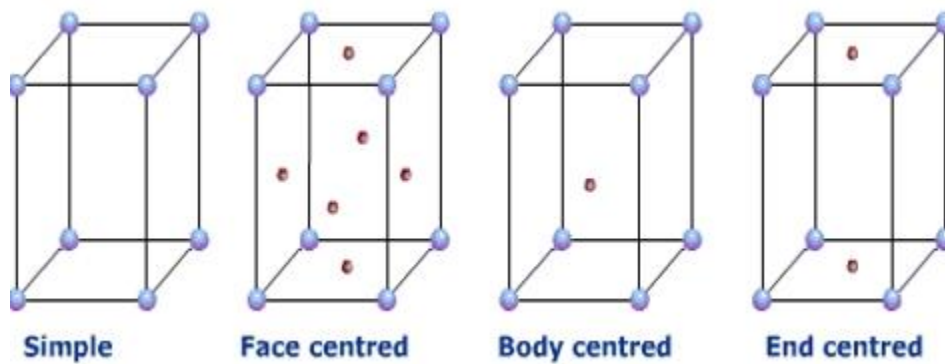

Figure 1.11.3 Orthorhombic Crystal System.

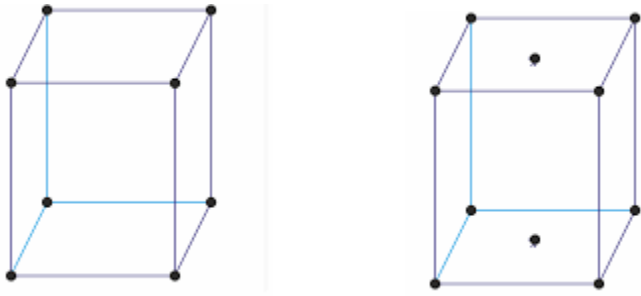

Figure 1.11.4 Monoclinic Crystal System.

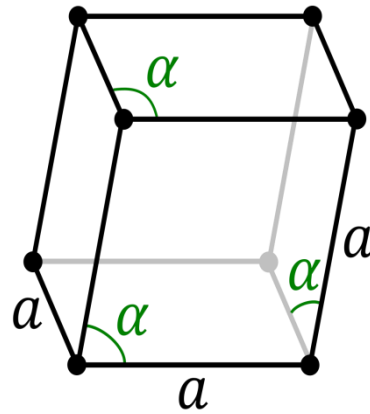
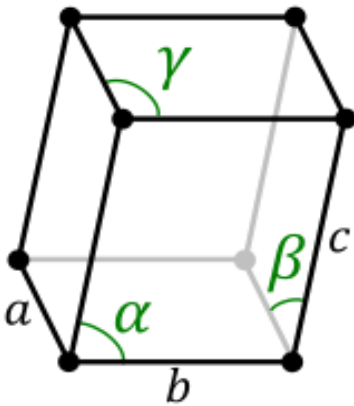

Figure 1.11.5 Triclinic Crystal System. Figure 1.11.6 Trigonal (Rhombohedral) Crystal

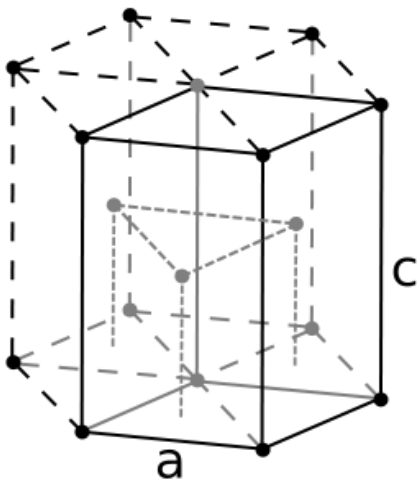

Figure 1.11.7 Hexagonal Crystal.

1.6 CUBIC CRYSTAL SYSTEM

The simplest and easiest structure is cubic crystal. There are three types of possible crystal structure under this family named as simple cubic, body centered cubic and face centered cubic crystal as shown in figure 1.11a.

1.6.1 Simple cubic crystal (sc)

In simple cubic crystal, lattice points are arranged at each 8 corner of cube. At each corner of cube, an atom is shared by 8 nearby unit cells. Therefore one unit cell contains $1/8 \times 8 = 1$ atoms. If we take an atom at one corner, we can be observed that it is surrounded by 6 nearest neighbor's atoms. The number of nearest neighbors of a lattice point (or atom) in a crystal lattice is called coordinate number. Hence the coordinate number of simple cubic crystal is 6. Example Cu, Ag, Au metals have this types of structure.

When we observe the structure, it can be seen that atoms touch each other along the edges as shown in figure 1.12. In the figure if a is lattice parameter and r is the radius of atom then

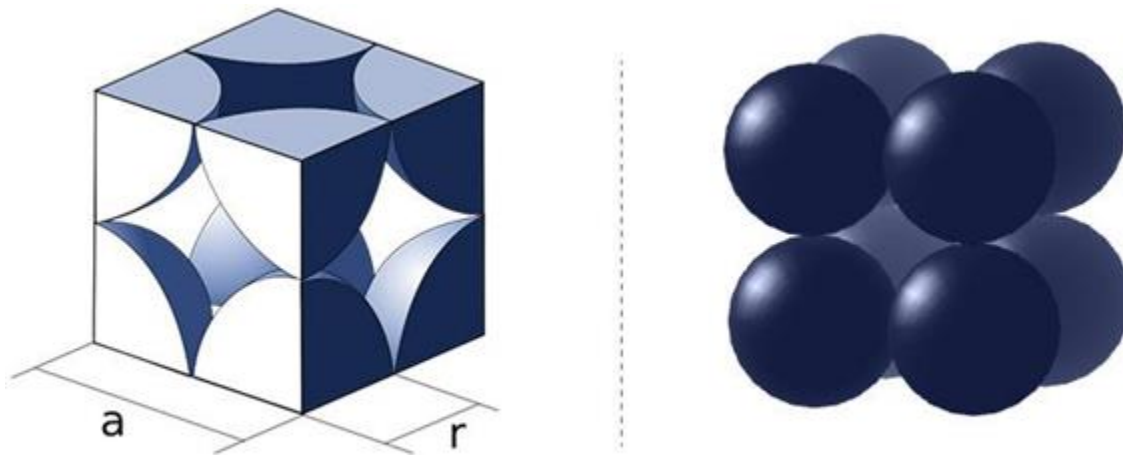

Figure 1.12: Cubic side length a and atomic radius r of simple cubic structure.

As seen from figure 1.12 we can summarize:

$$\text{Nearest neighbour distance} = 2r$$

$$\text{Lattice constant } a = 2r$$

$$\text{Coordinate number } CN = 6$$

$$\text{Number of atoms per unit cell} = \frac{1}{8} \times 8 = 1$$

$$\text{Volume of unit cell } (V) = a^3$$

$$\text{Volume of primitive cell } (V) = a^3$$

$$\text{Volume of atom inside the unit cell } (v) = 1 \times \frac{4}{3} \pi r^3 = \frac{4}{3} \pi r^3$$

$$\text{Packing fraction (PF)} = \frac{v}{V} = \frac{\frac{4}{3} \pi r^3}{a^3} = \frac{1}{6} \pi = \mathbf{0.52}$$

Packing fraction gives the idea about how much space of a unit cell is occupied by solid atoms. And define as

$$\text{PF} = \frac{\text{volume of atoms in unit cell}}{\text{volume of unit cell}}$$

1.6.2 Body centered cubic structure (bcc)

In this case of cubic crystal, one atom is arranged inside the cube additional to eight atoms at eight corners this structure is shown in figure 1.13. Many metals like Li, Na, K, Cr exhibit bcc crystal structure. In bcc lattice one atom is inside the unit cell entirely, and eight corners of lattice cube share 1/8 part of each atom. Therefore, the number of atoms in a bcc unit cell = $1 + 1/8(8) = 2$.

It can be seen from the arrangement of atoms in bcc lattice; the corner atoms do not touch each other but each corner atoms touch atoms inside the lattice. Therefore, the diagonal of unit cell is equal to $4r$ as shown in figure 1.13.

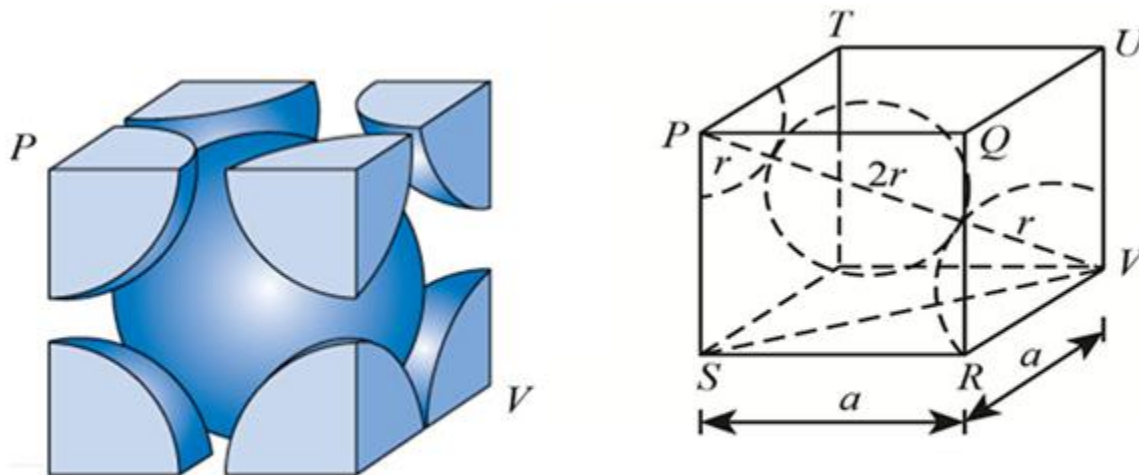

Figure 1.13: body centered cubic crystal.

From figure

$$SV^2 = SR^2 + RV^2 = a^2 + a^2 = 2a^2$$

$$PV^2 = SV^2 + PS^2 = 2a^2 + a^2 = 3a^2$$

$$4r^2 = 3a^2 \quad \text{or} \quad a = \frac{4}{\sqrt{3}} r$$

Thus we can summarize:

$$\text{Nearest neighbour distance} = \sqrt{3} \frac{a}{2} = \mathbf{0.866a}$$

$$\text{Lattice constant } a = \frac{4}{\sqrt{3}} r$$

$$\text{Coordinate number } \mathbf{CN} = \mathbf{8}$$

$$\text{Number of Lattice points (atoms) per unit cell} = 1 + \frac{1}{8} \times 8 = \mathbf{2}$$

$$\text{Volume of unit cell (V)} = a^3$$

$$\text{Volume of primitive cell} = a^3/2$$

$$\text{Volume of atom inside the unit cell (v)} = 2 \times \frac{4}{3} \pi r^3 = \frac{8}{3} \pi r^3$$

$$\text{Packing fraction (PF)} = \frac{v}{V} = \frac{\frac{8}{3} \pi r^3}{a^3} = \frac{\sqrt{3}}{8} \pi = \mathbf{0.68}$$

1.6.3 Face centered cubic crystal

In case of face centered cubic crystal (fcc), 8 atoms are arranged at eight corners of the cubic lattice and 6 atoms are arranged at the centre of eight faces of cube. Each atom of 8 corners is shared by 8 neighbor unit cells therefore one corner of cube shares 1/8 atom. On the other hand, each atom at the faces of cube is shared by 2 unit cell and each face shared 1/2 atom thus total 6 faces share $6 \times 1/2 = 3$ atoms. Therefore, net atoms inside a unit cell of fcc crystal is equal to $1/8 \times 8 + 1/2 \times 6 = 4$. If one atoms at the face as origin, then this atom is shared by two unit cells and there are 12 atom nearest to this atom. Thus the coordinate number of fcc crystal is 12. When we observe the face of fcc crystal lattice, it can be see that face centered atom touches all the atoms at its nearby corners as shown in figure 1.14.

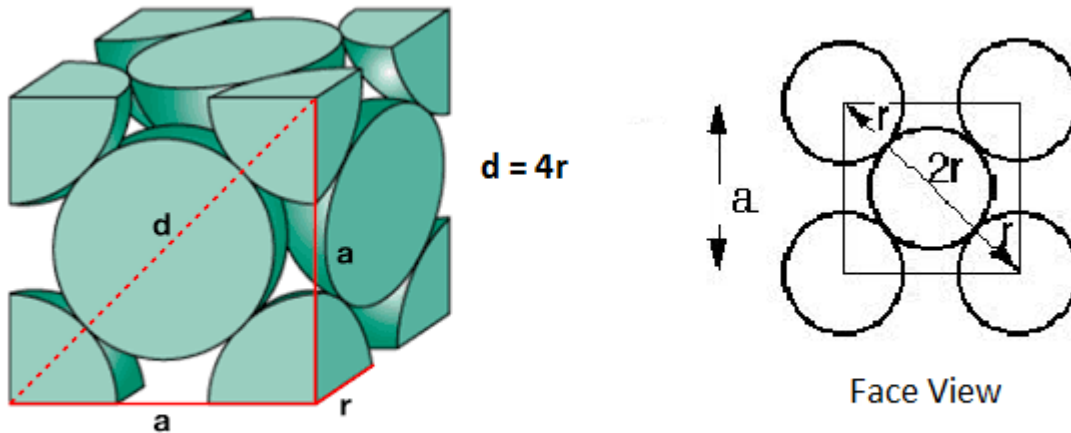

Figure 1.14.: Face centered cubic

From figure 1.14 face diagonal $d=4r$ therefore

$$(4r)^2 = a^2 + a^2 = 2a^2$$

$$16r^2 = 2a^2 \quad \text{or} \quad a = \frac{4}{\sqrt{2}}r$$

Thus we can summarize:

$$\text{Nearest neighbour distance} = \frac{a}{\sqrt{2}}$$

$$\text{Lattice constant } a = \frac{4}{\sqrt{2}}r$$

$$\text{Coordinate number } CN = 12$$

$$\text{Number of atoms per unit cell} = \frac{1}{8} \times 8 + \frac{1}{2} \times 6 = 4$$

$$\text{Volume of unit cell } (V) = a^3$$

$$\text{Volume of primitive cell} = a^3/4$$

$$\text{Volume of atom inside the unit cell } (v) = 4 \times \frac{4}{3}\pi r^3 = \frac{16}{3}\pi r^3$$

$$\text{Packing fraction (PF)} = \frac{v}{V} = \frac{\frac{16}{3}\pi r^3}{a^3} = \frac{\pi}{3\sqrt{2}} = 0.74$$

Some common example of fcc Crystal are Al, Cu, Au, Ag etc. These elements have monoatomic fcc crystal structure.

Table 2: The characteristics of cubic crystal

Parameters	Simple Cubic	Body centered	Face centered
1 Lattice constant (a)	$a = 2r$	$a = \frac{4}{\sqrt{3}}r$	$a = \frac{4}{\sqrt{2}}r$
2 Volume of unit cell (V)	a^3	a^3	a^3
3 Number of lattice point (atom) per unit cell	1	2	4
4 Volume of primitive cell	a^3	$a^3/2$	$a^3/4$
5 Coordinate number (Number of nearest neighbors)	6	8	12
6 nearest neighbors distance	a	$\frac{\sqrt{3}}{2}a$	$\frac{1}{\sqrt{2}}a$
7 Packing fraction (PF)	$\frac{\pi}{6} = 0.52$	$\frac{\sqrt{3}\pi}{8} = 0.68$	$\frac{\pi}{3\sqrt{2}} = 0.74$

1.7 SYMMETRY AND SYMMETRY OPERATION

Crystal symmetry describes the similarity in the lattice points and environment throughout the Crystal. The idea of symmetry is useful for the understanding of crystal structure. A crystal possesses different symmetry. These symmetries are described by certain operations. A symmetry operation is that which transform the Crystal to itself. Simply a symmetry operation interchanges the position of atoms which results the same appearance of crystal. The Crystal environment remains unchanged (invariant) under any symmetry operation. The symmetry operations are translation, rotation, reflection and inversion. Symmetry operations performed about a point or a line are called point group symmetry operations. On the other hand, symmetry operations perform by translation vectors are called space symmetry operations. There are total 230 space groups of entire crystal system. Further, there are 32 point group which describe all symmetry operation about a point in space with does not move during operation. The symmetry operations are described below

1.7.1 Translation Symmetry

In translation symmetry, a lattice point \mathbf{r} under a lattice translation operation performed by translation vector \mathbf{T} , gives another point \mathbf{r}' which is exactly identical to initial point \mathbf{r} . If lattice translation vector \mathbf{T} is given as

$$\mathbf{T} = n_1\mathbf{a}_1 + n_2\mathbf{a}_2 + n_3\mathbf{a}_3 \text{ where } n_1, n_2, n_3 \text{ are integer numbers. then}$$

$$\mathbf{r}' = \mathbf{r} + \mathbf{T}$$

1.7.2 Rotational Symmetry

In rotational symmetry, if a crystal is rotated through a point by an angle Θ , it transforms the lattice to another lattice which is again itself in appearance. For simplest example is the crystal lattice is rotated by an angle Θ is 360° its lattice arrangement remains same.

For rotational symmetry

$$n\theta = 2\pi \quad \text{or} \quad \theta = \frac{2\pi}{n}$$

Possible value of n are 1,2,3,4,6 only. n is called multiplicity of rotational axis. Lattice can be found as one, two, three, four and six fold rotation about an axis which carries the lattice to itself. It can be seen that a lattice cannot transform into itself under the rotation like $\frac{2\pi}{5}, \frac{2\pi}{7}, \frac{2\pi}{9}$ etc. If we have 5 fold symmetry, then pentagon could not fitted to each other in space under this rotation. Thus the five fold symmetry is not possible under rotation.

1.7.3 Reflection

If the lattice has a plane or line in two dimensional which divide the lattice into two halves which are mirror image of each other than this is called reflection symmetry such a plane is symbolically represented by letter small m.

1.7.4 Inversion

Inversion is a symmetry operation which is applicable in three dimensional lattice structure only. In this symmetry if we consider a point as centre of symmetry, and locate all points by lattice vector \mathbf{r} then $-\mathbf{r}$ (inversion of sign) give the same lattice. The centre of inversion of lattice is denoted by symbol $\bar{1}$ and read as one bar.

1.8 CRYSTAL DIRECTION AND PLACE

In a crystal lattice, it is necessary to locate the directions and planes for its analysis. In a crystal lattice the directions are given by the coordinates of first whole number point. In figure 1.15 there are two dimensional and three dimensional lattices. In two dimensional lattice if lattice point O is considered as origin then the directions OA and OB are denoted by their coordinates of first points [1, 1] and [2 1] respectively. Similarly, in three dimensional lattice directions OC and OA are denoted by [111] and [110] which are the coordinate of first lattice point in the line. Similarly, other directions are also shown in the figure. Generally square bracket [] is used for representing direction in a crystal lattice. The directions of cube edges are represented by [100], [010], [001].

A family of directions of a particular type of is presented by enclosing Miller Indices into a $\langle \rangle$. Thus the directions edges of cubic lattice constitute a family of directions denoted by $\langle 100 \rangle$.

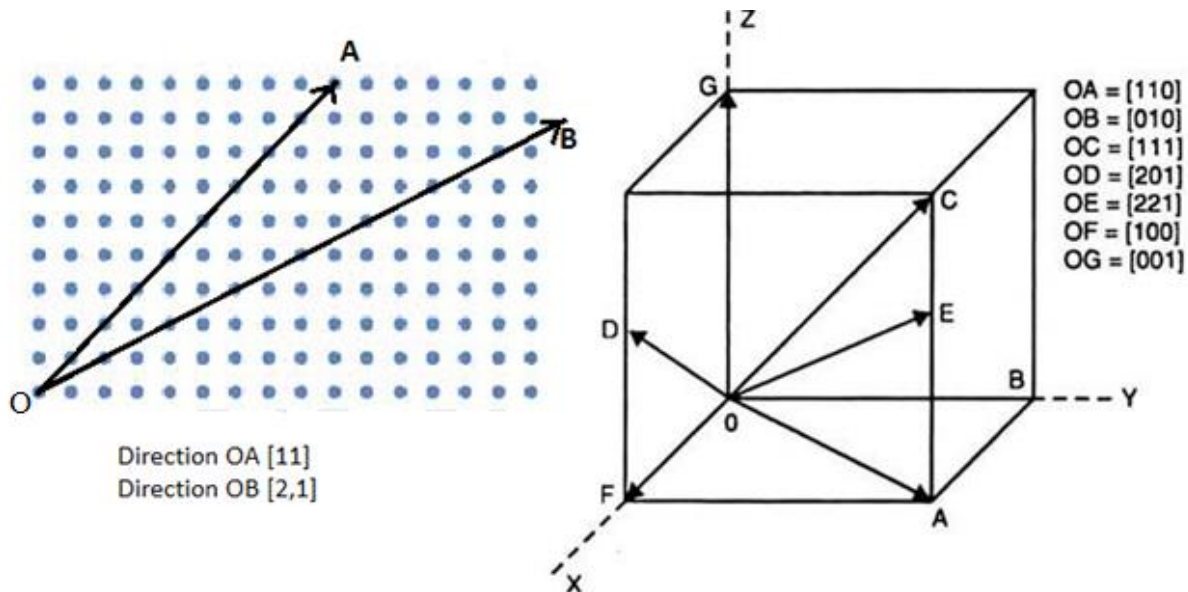

Figure 1.15: Crystal Directions in 2 D and 3 D

1.8.1 Miller Indices

Crystal is made up an aggregate of a large number of parallel equidistance planes in which lattice points are arranged in ordered manner. The orientation of the planes is first defined by Miller, and known as Miller Indices. Miller indices represent the set of parallel planes. Miller Indices of a plane is obtained by following 3 steps:

- (1) Find out the Intercepts of plane on the three crystal axis x, y, z.
- (2) Take reciprocals of these intercepts
- (3) Find out simplest ratio in integer number.

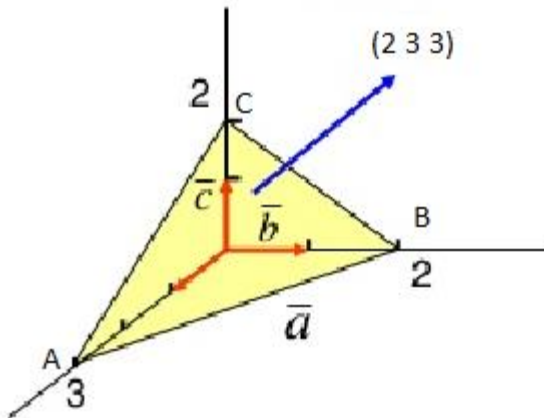

Figure 1.16: Miller Indices of crystal Plane.

Miller Indices is generally written as $(h\ k\ l)$ in small bracket. In Figure 1.16 $\bar{a}, \bar{b}, \bar{c}$ are lattice vectors along x, y, z axis respectively. A plane ABC cut three axes at points A, B and C with coordinates $3\bar{a}, 2\bar{b}, 2\bar{c}$ respectively. Now the Miller indices can be obtained as:

- (1) Intercepts of plane on the three crystal axis x, y, z is 3, 2, 2.
- (2) Reciprocals of these intercepts are $1/3, 1/2, 1/2$
- (3) Simplest ratio of reciprocals in integer number are 2, 3, 3

Thus Miller indices $(2\ 3\ 3)$

The indices $(h\ k\ l)$ may denote a single plane or set of parallel planes. If a plane cuts in negative axis negative sides of origin then we put a negative sign above the axis as $(\bar{h}\ \bar{k}\ \bar{l})$. A family of planes of a particular type of is presented by enclosing Miller Indices into a $\{\}$ brass. For example the cube faces of a cubic crystal (100) (010) (001) $(\bar{1}00)$ $(0\bar{1}0)$ $(00\bar{1})$ represented by family $\{100\}$. Figure 1.17 indicates the indices of different planes of a cubic crystal family $\{100\}$.

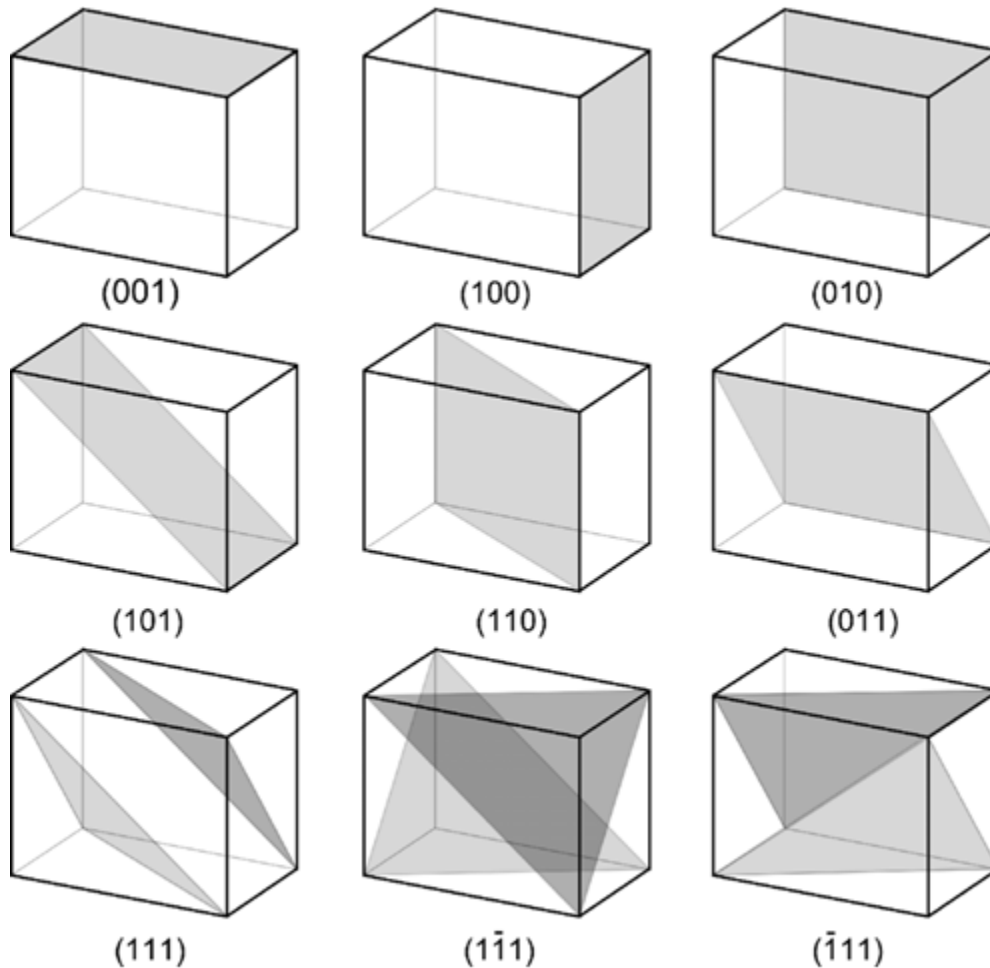

Figure 1.17 Millar indices of different planes of a cubic crystal family $\{100\}$.

1.8.2 Inter planer Spacing

Crystal can be considered as arrangement of equidistance planes on which the lattice points are situated in a regular manner. Now we can calculate the interspacing distance (separation) between two planes. This distance is significant parameter when we study the crystal diffraction. Consider a set of parallel planes with indices $(h\ k\ l)$ and among these planes, one plane is passing through origin O . The next plane lies just parallel to first plane and gives intercepts a/h , b/k , c/l on x , y , z axis as shown in figure 1.18 where a , b , c are lattice vectors of a crystal. ABC is plane which intercepts x , y , z axis at points A , B , C respectively. If we draw a perpendicular ON from O to plane ABC then $ON=d$.

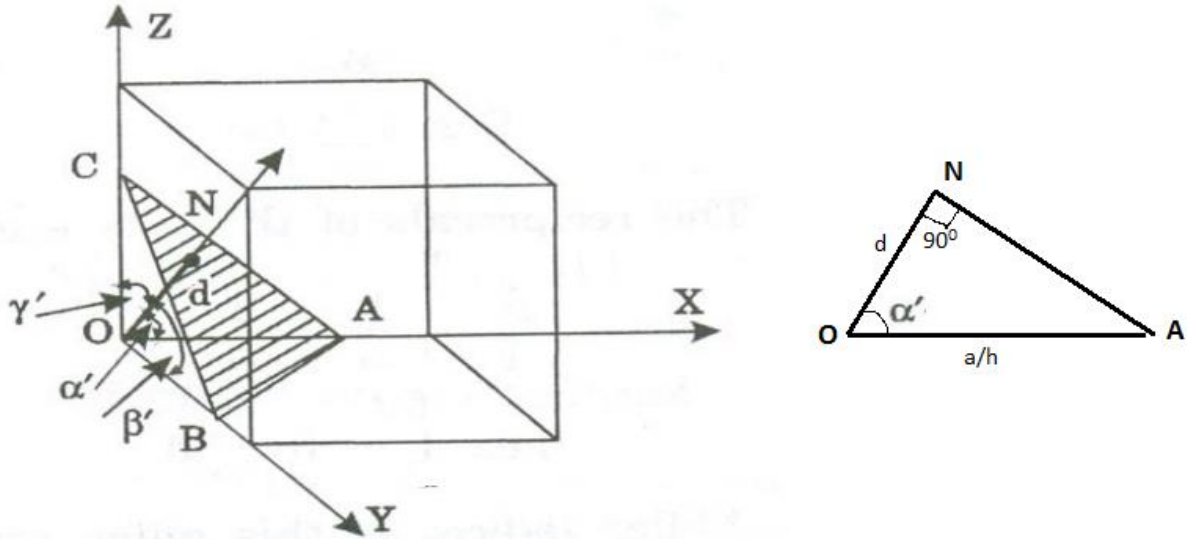

Fig: 1.18 Separation between Lattice Planes in a Crystal

Let us consider perpendicular ON makes angle α' , β' , γ' with x, y, z axis respectively then we can consider a ΔOAN as shown in figure 1.18 then

$$\cos \alpha' = \frac{ON}{AO} = \frac{d}{a/h} = \frac{hd}{a}$$

Similarly, for other angles

$$\cos \beta' = \frac{ON}{BO} = \frac{d}{b/k} = \frac{kd}{b}$$

$$\cos \gamma' = \frac{ON}{CO} = \frac{d}{c/l} = \frac{ld}{c}$$

According to cosine law

$$\cos^2 \alpha' + \cos^2 \beta' + \cos^2 \gamma' = 1$$

Putting the value of $\cos \alpha'$, $\cos \beta'$, $\cos \gamma'$

$$\left(\frac{hd}{a}\right)^2 + \left(\frac{kd}{b}\right)^2 + \left(\frac{ld}{c}\right)^2 = 1$$

$$d = \frac{1}{\sqrt{\left(\frac{h}{a}\right)^2 + \left(\frac{k}{b}\right)^2 + \left(\frac{l}{c}\right)^2}}$$

This is general expression for inter-planer spacing which is valid for orthogonal crystal lattice only. In case of cubic crystal, $a = b = c$ then above expression becomes

$$d = \frac{a}{\sqrt{(h)^2 + (k)^2 + (l)^2}}$$

1.9 SOME IMPORTANT CRYSTAL STRUCTURE

Now we discuss structure of some materials which are commonly used. For general understanding we can discuss simple crystal like sodium chloride (NaCl), cesium chloride (CeCl), hexagonal close packed (hcp), Diamond, zinc sulfide (ZnS), perovskite etc. Generally crystal structure can be classified as below.

Classification of Crystal Structure:

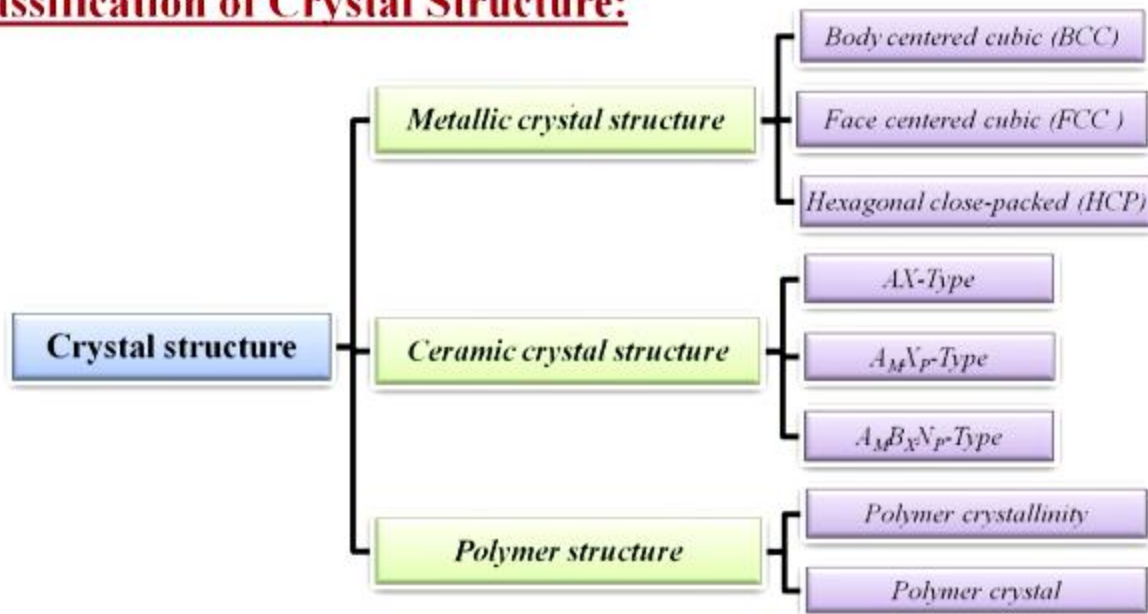

Crystal structure is divided into three parts, one is called the metallic crystal structure, then ceramic crystal structure and last one is the polymer structure. If we see the metallic crystal structure, we can find three types of structure, one is called the bcc (body centered cubic), then fcc (face centered cubic), and last one is the hcp (hexagonal closed packed) structure. We have already studied these structures. When we are talking about the ceramic crystal structure generally it is AX-Type, $A_M X_P$ Type, $A_M B_X N_P$ Type, and when we are talking about the polymer structure, so generally polymer crystallinity and polymer crystal.

Now we are going to briefly discuss about the ceramic crystal structures, so ceramics are compounds between metallic and non-metallic elements, they have interatomic bonds either totally ionic or with covalent characteristics, many ceramics have a combination of these two bonding types, so we can see ionic bond as well as we can see the covalent bond, that degree of ionic character is being dependent on the electronegativities of the atoms. They are examples of inorganic metallic materials like silicates, aluminates, oxides, carbides, borides and the hydroxides. Most common AX (cations and anions are represented by A and X) structure is sodium chloride (NaCl) or maybe the rock salt type, so coordination number for both cations and anion is 6, unit cell is generated from an fcc type. Other examples are examples of the cesium chloride structure zinc blende structure, Zinc sulfide, zinc tellurium and silicon carbide.

$A_M X_P$ Type Crystal Structure, are formed if the charges on the cations and anions are not the same, a compound can exist with the chemical formula $A_M X_P$ where M and P not is equal to 1, so for examples CaF_2 which is known as the fluorite. Coordination number of cation Ca^{+2} is 8 and anion F^- is 4. Other examples are zirconium oxide, uranium oxide, plutonium oxide or maybe the thorium oxides. The third type is $A_M B_X N_P$ type Crystal Structure, so it is also possible for ceramic compounds to have more than one type of cations, so here generally two types of cations are present, so for two types of cations represented by A and B, their chemical formula maybe designated as $A_M B_X N_P$, so for example $BaTiO_3$.

So some common ceramic crystal structure, examples so like rock salt structure type is AX at anion packing is FCC, here the cation number is 6, anion is 6, example sodium chloride FeO , MgO like that, cesium chloride so generally $CsCl$, so here it is simple cubic cation and anion number is also equal, for zinc blende also it is equal, zinc sulfide and silicon carbide, for fluorite generally it is AX_2 type structure type, here the cation number is 8, and the anion number is 4, so CaF_2 or UO_2 or maybe ThO_2 , generally we are talking about the Perovskite materials nowadays it is been widely used for the solar cells, so generally the structure type is ABX_3 or fcc in structure, in this particular case, anion is 6, like $BiTiO_3$, $SrZrO_3$, $SrSnO_3$ like this, if we are talking about the spinel generally the crystal structure type is AB_2X_4 , FCC in structure here also 2 cations are present 4A and 6B, and anions number are 4, so example is magnesium, aluminate, or maybe $FeAl_2O_4$.

1.9.1 Sodium Chloride (NaCl) Structure

Rock salt (NaCl) structure type is AX at anion packing is fcc, here the cation number is 6, anion is 6. A basis consist one Na and one Cl. In a unit cell there are four primitive cells shown in figure 1.19. If a is lattice parameter (side length of cubic unit cell) then the position of Cl and Na atoms are:

Cl : 0, 0, 0; 1/2, 1/2, 0; 1/2, 0, 1/2; 0, 1/2, 1/2;
Na : 1/2, 1/2, 1/2; 0, 0, 1/2; 0; 0, 1/2, 1/2; 1/2, 0, 0

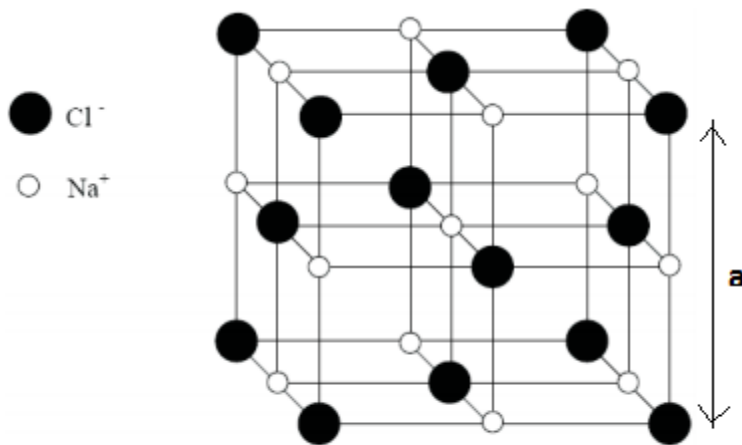

Figure 1.19: Structure of NaCl

The separations between two Na (or Cl) atoms are half of the face diagonal of unit cube and the separation between two basis is half of the body diagonal of cube as shown in figure 1.19. Each ion (Na and Cl) is surrounded by six nearest neighbor of opposite kind. The coordinate number of each Na and Cl atom in this structure is 6. Other examples of NaCl (AX) type structure are KBr, KCl, MgO, AgBr.

1.9.2 Cesium Chloride (CsCl) Structure

Cesium chloride (CsCl) structure type is AX at anion packing is body centered cubic. In this structure there are two primitive cells in a cubic unit cell. Thus each unit cell has two molecule (basis) of CsCl. As shown in the figure 1.20, the Cl ion is at $(0, 0, 0)$ and Cs ion is at $(1/2, 1/2, 1/2)$. The Cs is situated at body center and 8 Cl ions at the corner of unit cell. Similarly if we extend the unit cell we can see a Cl ion is surrounded by 8 Cs ions. Thus the coordinate number of CsCl is 8. The other examples of CsCl type structure are RbCl, LiHg etc.

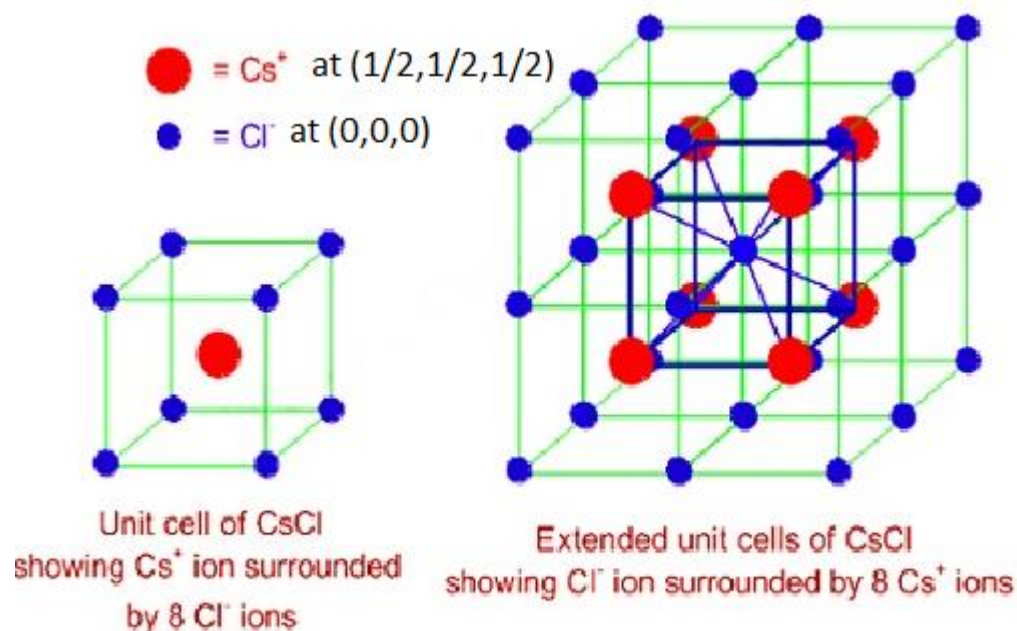

Figure 1.20: CsCl Structure

1.9.3 Diamond Structure

The diamond structure is face centered cubic with four additional atoms in the body diagonals. Out of four additional atoms, two atoms are placed at $\frac{3}{4}$ length of first and second diagonal, remaining two atoms are placed at $\frac{1}{4}$ lengths of 3rd and 4th body diagonals as shown in figure 1.21. To draw the diamond structure, first we construct a face centred cubic unit cell and place the 8 C atoms at all 8 corners, and 6 C atoms at 6 face centres. Now we draw 4 body diagonals as shown by red lines and place one C atom at each diagonal at $\frac{1}{4}$, $\frac{3}{4}$, $\frac{1}{4}$, $\frac{3}{4}$ respectively. Total number of C

atoms is 18. The whole appearance seems complicated thus for simplicity, some time we draw the projection of atoms on a plane (say XY plane) as shown in figure 1.22. In figure 1.22 only five atoms are at the face (base of cube) ABCD in actual and other atoms are projections of atom near to face. Points E, G, M, K show the projection of atoms at vertical faces of cube and z coordinate of actual position of these atoms are $\frac{1}{2}$ as shown in figure. We write only z coordinates of projected atom explicitly. Now point F, H, J, L shows the projection of atoms situated at 4 body diagonals and z coordinates of these atoms are $\frac{1}{2}$, $\frac{3}{2}$, $\frac{1}{2}$, $\frac{3}{2}$ as shown in figure 1.22. Figure 1.21 gives 3D view and 1.22 gives 2D view. The coordinate number (number of nearest neighbours) is 4 and each group of 4 C atoms make a tetrahedral bond arrangement. The packing fraction of diamond structure is 0.34 which is considerably small with comparison of fcc structure (PF 0.74) and shows relatively empty space in the crystal.

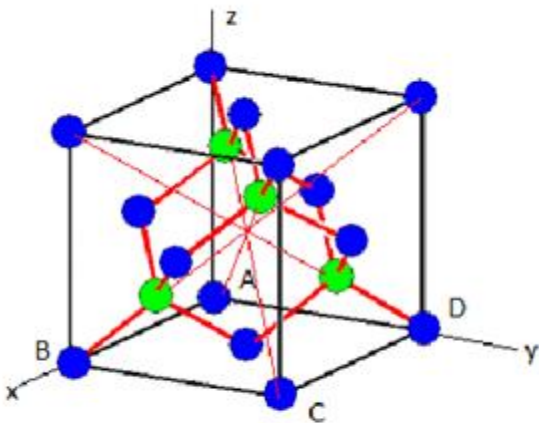

Figure 1.21: Dimond Structure

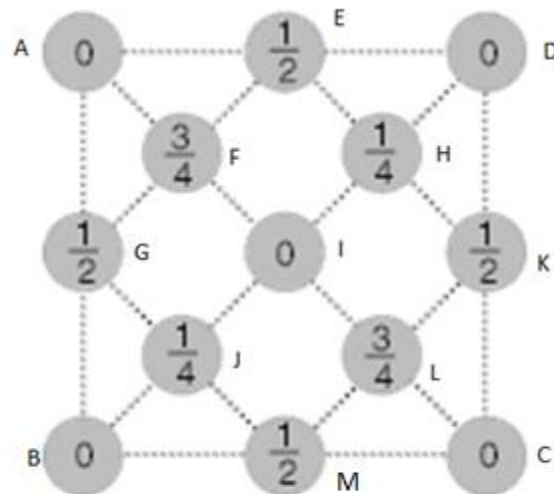

Figure 1.22: Projection on atoms on face ABCD

1.9.4 Zinc Sulphide (Zinc Blende) Structure

Cubic zinc blende (ZnS) crystal structure is similar to diamond structure the only difference is that the four diagonal atoms are of different type. ZnS structure becomes diamond structure if all the diagonal atoms and fcc atoms are same type. In figure 1.23, circles represent one type of atoms (say Zn atoms) and dark circles show another types of atoms (say S atoms). ZnS structure is a prototype and many other compound form ZnS structure as ZnO, GaAs, SiC, BN etc.

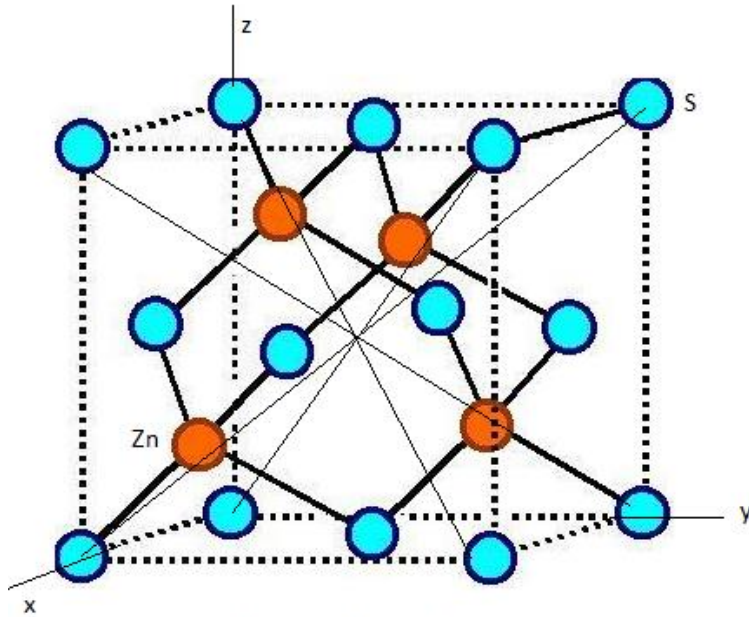

Figure 1.23: Zinc Blende Structure

1.9.4 Hexagonal close packed (hcp) Structure

Hexagonal close packed are generally found in monoatomic crystal structure such as metals. In hcp consider a layer of similar atoms say A, in which each atom is surrounded by six atoms are arranged on the plane of paper as shown in figure 1.24. Now another layer of atoms of type B is placed on the paper just above the layer A such as each atoms of type is fitted on the depressions formed by the atoms of layer A. A third layer of atoms of atoms of A type is again placed on the layer B in same manner. Thus the repetition of layers as ABABABAB.....one upon one we get hpc structure.

The three dimensional structure of hcp is shown in figure 1.25. In this figure, six atoms of one type (A type) are arranged at six corners of base hexagon. Six same atoms of A type are placed just upon the top of hexagon at height (distance) c . These two hexagons (base and top) form a unit cell. Now just between these two hexagons three atoms of type B are situated (at height $c/2$), as shown in figure 1.25.

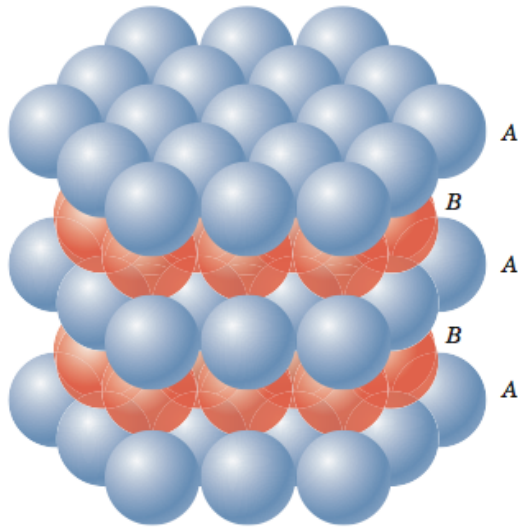

Figure 1.24: Layers of A, B types atoms in hcp

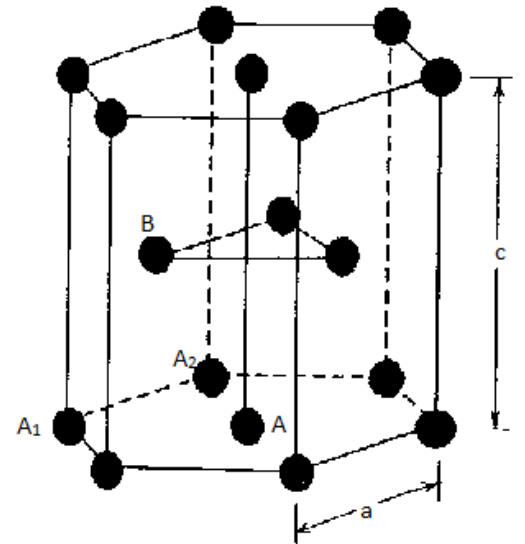

Figure 1.25 : Unit cell of hcp

The effective number of atoms in a unit cell is $12 \times \frac{1}{6} + 2 \times \frac{1}{2} + 3 = 6$. The first term arises as the 12 corners of base and top hexagons contain 12 atoms and each corner atom shared by 6 neighbor hexagons. Thus these atoms contribute $12 \times \frac{1}{6}$. Similarly, second term arises as center of top and bottom hexagons, have 2 atoms which are shared by 2 hexagons thus it contributes $2 \times \frac{1}{2}$. In the third term, 3 atoms (may be type B) are fully inside the unit cell between top and base hexagon thus it contributes 3 in the unit cell. Thus total 6 atoms are in a unit cell of hcp. If a is interatomic distance in the layer of hexagon i.e. side length of hexagon, and c is the height then we can calculate the ratio c/a which is a standard parameter for hcp structure and calculated as below.

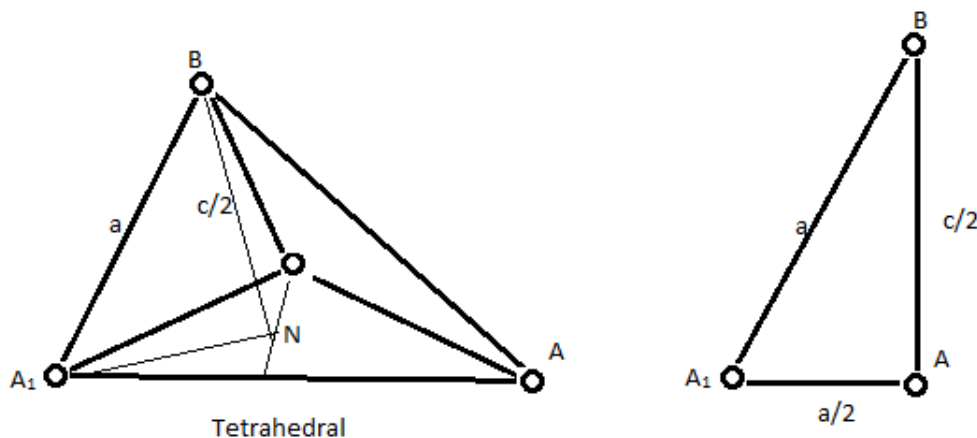

Figure 1.26 : Tetrahedral formed by atoms from A and B layers

If we connect B_1 atom of layer B to atoms A, A_1, A_3 atoms of layer A as shown in figure 1.26, then atoms B, A, A_1, A_3 form a tetrahedral of height $c/2$. If BN is perpendicular from B to triangle A, A_1, A_3 then in triangle BA_1N

$$a^2 = (c/2)^2 + (A_1N)^2$$

As triangle AA_1A_3 is equilateral, then in triangle A_1NA_2

$$\cos 30 = \frac{a/2}{A_1N}$$

$$A_1N = \frac{a}{\sqrt{3}}$$

Putting the value of A_1N in above relation

$$a^2 = (c/2)^2 + \left(\frac{a}{\sqrt{3}}\right)^2$$

$$\frac{c}{a} = 1.633$$

Thus for ideal hcp c/a ratio is 1.633.

The packing fraction is defined as ratio of total volume of atoms in a unit cell to volume of unit cell.

$$\text{Packing fraction (PF)} = \frac{v}{V} = 6 \times \frac{\frac{4}{3}\pi r^3}{6 \times \frac{\sqrt{3}}{4}a^2 \times c} = \mathbf{0.74}$$

The coordinate number CN (number of nearest neighbours) is 12 as shown in figure 1.25. It can be seen CN and PF is same as fcc crystal. The hcp structure is also shown by Cd, Mg, Ti, Zn crystals. Generally, 90% metals show bcc, fcc or hcp structure.

1.10 WIGNER SEITZ CELL

There are several ways to choose a primitive cell or unit cell in a crystal. A convenient way of choosing the unit cell is the area covered by perpendicular bisectors of lines joining the nearest neighbours. In 3D the smallest volume enclosed in this way is called Wigner Seitz cell. Wigner Seitz cell is special type of unit cell, which describes the symmetry of cell. A Wigner–Seitz cell is an example of a primitive cell, which is a unit cell containing exactly one lattice point. For any given lattice, there are an infinite number of possible primitive cells. However there is only one Wigner–Seitz cell for any given lattice. It is the locus of points in space that are closer to that lattice point than to any of the other lattice points.

In practice, the Wigner–Seitz cell itself is actually rarely used as a description of direct space, where the conventional unit cells are usually used instead. However, the same decomposition is extremely important when applied to reciprocal space. The Wigner–Seitz cell in

the reciprocal space is called the Brillouin zone, which contains the information about whether a material will be a conductor, semiconductor or an insulator.

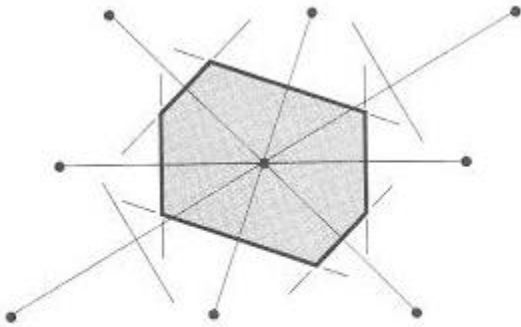

Figure 1.27: Wigner Seitz cell

1.11 QUASI CRYSTA

In terms of symmetry, crystalline solids are those in which 2,3,4,6 fold and translational symmetry exhibits. Previously during the development of crystallography it was assumed that fivefold symmetry is not possible but later on, it was observed there are some crystal with yours 5,7,8 fold symmetries and are called forbidden symmetry. Such crystals are called quasi crystals. On the other hand, non-crystalline solid does not exhibit rotational and translational symmetry. Numbers of solids like platonic solids as shown in figure 1.28, exhibit fivefold symmetry. In this figure two platonic solids out of five show, named Dodecahedron and Icosahedron show fivefold symmetry. Another example of fivefold symmetry is burg man cluster in which a complex unit cell is formed by total 90 atoms out of which 60 carbon atom and 20 Zn-Mg atom.

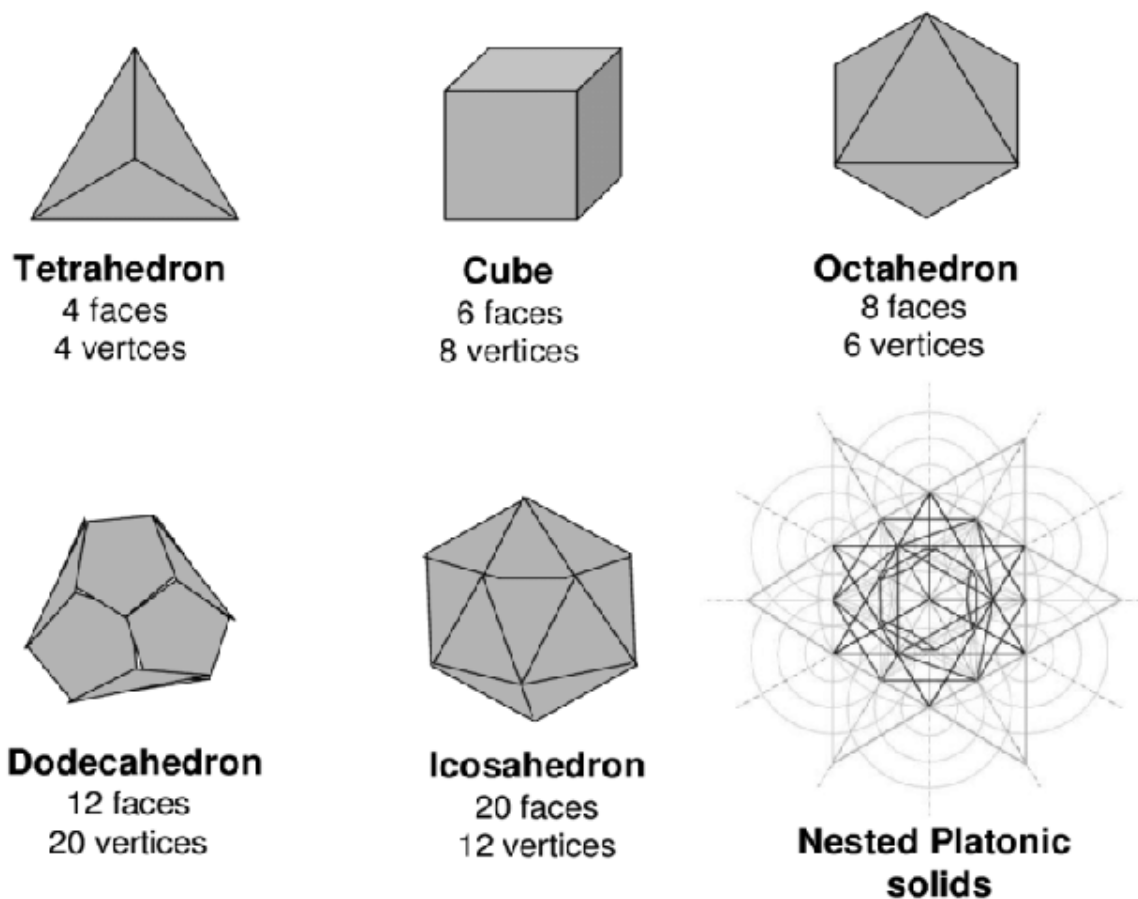

Figure 1.28 Platonic Solids

1.12 LIQUID CRYSTAL

Generally, when solids are heated up, it changes into liquid state but there are some solids, when they are heated, not directly change into liquid state but it goes through an intermediate state and state is called liquid solids. This mixed state of solid and liquid has property in between true crystals solid and true liquid. Main properties of liquid crystals are as ordered arrangement of particles, optically active, fluidity, viscosity, and surface tension. Liquid crystals have state which flow like a liquid but have ordered arrangement of atoms. In, 1888, Frederick Reinifzer an Austrian Botanists discovered first liquid crystal Cholesteryl benzoate used for hair color.

12.1 Uses of liquid crystals

1. Liquid crystals are used in display of electrical device known as LCD.
2. Liquid crystals are used as temperature sensor in thermometers.
3. Used in medical sciences for locating blockage in veins, arteries, infections and tumors by skin thermograph. Skin thermograph indicates temperature of body as the colour of liquid crystal placed

on the body changes with temperature. The temperature of infected cells of body have more temperature than normal cells which shows different colours at the blockage and infected location.

Self assessment questions (SAQ)

SAQ1: What are the seven types crystal lattice systems?

Solution: There are seven crystal lattice systems-

(i) Cubic (ii) Trigonal (iii) Hexagonal (iv) Tetragonal (v) Orthorhombic (vi) Monoclinic (vii) Triclinic

SAQ2: What are the cubical crystal systems?

Solution: In a cubical crystal system, the unit cell is a cube. All cubical systems have one atom each in all the corners of the cube. Each atom has $1/8^{\text{th}}$ of its volume contained within the cube. In addition to this arrangement, each cubical system has its own extra atomic configuration. In general, there are three cubical crystal systems-

(i) Simple cubical lattice (ii) Body centred cubical lattice (iii) Face centred cubical lattice

SAQ3: Thecell is the smallest unit cell that can be repeated to form the lattice.

Solution: primitive

SAQ4: A BCC system has.....atoms in its unit cell.

Solution: 2

SAQ5: An FCC system has..... atoms in its unit cell.

Solution: 4

1.13 SUMMARY

1. In this unit, we have studied about crystalline solids, crystal structure, properties based on structure.
2. A crystal or crystalline solid is formed by regular repetition of its building blocks (atoms or molecule) in a three dimensional periodic array. Thus a crystal is formed by adding atoms or molecules in constant environment.
3. In actual case, crystalline solid is composed of a bunch of large number of small crystal grains. These grains are arranged in a random manner and joint to each other at certain boundaries called green boundaries. Such crystalline solids are called poly crystal.
4. If constituents of crystal are arranged in a regular manner up to a large scale size in macroscopic range ($\approx 1\text{mm}$ order) such crystal specimen is called single crystal.
5. Amorphous solids are those materials in which constituents (atoms or molecules) are not arranged in a regular manner over a long range.
6. Logically a crystal structure is given as:

Crystal structure = lattice + basis

7. The lattice is defined by three fundamental vectors $\mathbf{a}_1, \mathbf{a}_2, \mathbf{a}_3$ in such a way that all the lattice points in the crystal can be denoted by using these vectors.

8. For describing crystal structure, it is convenient to divide the crystal into small entities such small group of atoms or molecules is a well defined arrangement. These small cells are called unit cells.

9. The seven types of Crystal system which contains total 14 types of lattice. The 7 types of crystal system are named as cubic, tetragonal, orthorhombic, monoclinic, triclinic, triangular (rhombohedral) and hexagonal.

10. The idea of symmetry is useful for the understanding of crystal structure. A crystal possesses different symmetry. These symmetries are described by certain operations. A symmetry operation is that which transform the Crystal to itself.

11. In a crystal lattice the directions are given by the coordinates of first whole number point. Generally square bracket [] is used for representing direction in a crystal lattice. The directions of cube edges are represented by [100], [010], [001]. A family of directions of a particular type of is presented by enclosing Miller Indices into a $\langle \rangle$.

12. Miller indices represent the set of parallel planes. The indices (h k l) may denote a single plane or set of parallel planes. If a plane cuts in negative axis negative sides of origin then we put a negative sign above the axis as $(\bar{h} \bar{k} \bar{l})$. A family of planes of a particular type of is presented by enclosing Miller Indices into a { } brass.

13. This is general expression for inter-planer spacing which is valid for orthogonal crystal lattice

$$d = \frac{1}{\sqrt{\left(\frac{h}{a}\right)^2 + \left(\frac{k}{b}\right)^2 + \left(\frac{l}{c}\right)^2}}$$

For cubic crystal

$$d = \frac{a}{\sqrt{h^2 + k^2 + l^2}}$$

14 . A convenient way of choosing the unit cell is the area covered by perpendicular bisectors of lines joining the nearest neighbours. In 3D the smallest volume enclosed in this way is called Wigner Seitz cell.

15. There are some crystal with yours 5,7,8 fold symmetries and are called forbidden symmetry. Such crystals are called quasi crystals.

16. There are some solids, when they are heated, not directly change into liquid state but it goes through an intermediate state and state is called liquid crystals.

7.14 GLOSSARY

Array- arrangement.

Periodicity- the process of occurring something at regular manner.

Disordered- tangled, lawless.

Macroscopic- visible to naked eye without use of any instrument.

7.15 REFERENCES

C Kittel, Introduction to Solid State Physics 7th Edition, John Wiley and Sons, Singapore

H C Gupta, Solid State Physics, Visas Publication House, New Delhi

<https://www.researchgate.net/publication/264386832>

<https://byjus.com/chemistry/bcc-fcc-primitive-cubic-unit-cell/> (fig.1.12)

Introduction to Solid State Physics, Arum Kumar, PHI Learning Private Limited, New Delhi

7.16 SUGGESTED READING

1. OS Pillai, Solid state *Physics*, New Age International(P) limited, New Delhi
2. Solid State Devices, B.Somanathan Nair, S.R. Deepa, PHI Learning Private Limited, New Delhi.
3. Fundamentals of Solid State Physics, B.S. Saxena, R.C. Gupta, P.N. Saxena, Pragati Prakashan Meerut.

7.17 TERMINAL QUESTIONS

7.16.1 Short Answer Type Questions

1. Explain the crystalline and amorphous solids.
2. What do you mean by primitive basis and unit cell?
3. What is meant by basis?
4. What are primitive cell and unit cell in solids? Explain.
5. Which rotations are allowed in a lattice?

6. What are the different types of Bravais lattices for a cubic system? Give their names.
7. How does a crystal differ from a lattice?
8. What is the difference between single crystal and poly crystal?
10. Explain the seven types crystal system.
11. What is primitive lattice cell? How Wigner-Seitz cells are formed? Discuss Bravais lattices. Give different types of crystal structure.

7.16.2 Long Answer Type Questions

1. Explain the unit cell and primitive cell. Explain the symmetric operation in a crystal.
2. What are Bravais lattices. Explain seven types crystal systems and draw possible Bravais lattices in three dimensional space.
3. Explain the concept of Miller indices. With the help of diagram, find out the Miller indices of a simple cubic crystal.
4. Obtain the expression for inter planar separation of a crystal.
5. What is a crystal structure? Draw the crystal structure of NaCl crystal and explain its lattice vectors, primitive vector, coordination number, packing fraction.
6. What is a crystal structure? Draw the diamond structure and explain its lattice vectors, primitive vector, coordination number, packing fraction.
7. Explain the structure of hexagonal close packed structure and obtain the c/a ratio of hcp.
8. What is packing fraction of a crystal? Obtain the packing fraction of sc, bcc and fcc crystal.

7.16.3 Objective Type Questions

Choose the correct option-

1. Long range order is found in-
 - (a) amorphous (b) crystalline (iii) in both (iv) none of these
2. Which relation is correct-
 - (a) Lattice + crystal structure = basis (b) lattice + basis = crystal structure
 - (c) lattice – basis = crystal structure (d) basis + crystal structure = lattice
3. In three dimensions, the number of Bravais lattices is-
 - (a) 7 (b) 5 (c) 10 (d) 14

UNIT 2 CRYSTAL DIFFRACTION AND RECIPROCAL LATTICE

Structure

2.1 Introduction

2.2 Objectives

2.3 X-Ray Diffraction and Bragg's Law

2.4 Diffraction methods

2.4.1 Laue Method

2.4.2 Rotating crystal method

2.4.3 Powder Method

2.5 Reciprocal Lattice

2.5.1 Reciprocal Lattice vectors

2.5.2 Reciprocal Lattice of sc

2.5.3 Reciprocal Lattice of bcc

2.5.4 Reciprocal Lattice of fcc

2.6 Diffraction condition in reciprocal lattice

2.7 Brillouin zone

2.8 Summary

2.9 Glossary

2.10 References

2.11 Suggested Readings

2.12 Terminal Questions

2.12 Answers

2.1 INTRODUCTION

In the previous unit, we have studied about crystal structure, structure types, unit cell, some parameters related to crystal structure like coordination number, atomic radius, packing fraction, lattice constants of a lattice, density of lattice points in a lattice plane, symmetry operation etc. In the present unit, we will study about X-ray diffraction by crystal, Bragg's law, different method of diffraction, reciprocal lattice, and learn about the determination of crystal structure.

After the discovery of X-rays in 1895, it was assumed that X-rays are electromagnetic wave, and it would show diffraction. Wavelengths of X-rays are of the order of 10^{-8} to 10^{-9} cm, and spacing between the layers of atoms in a crystal is in order of 10^{-8} cm, which are of the same order. Therefore, in 1912, German physicist Max Vor Laue suggested that the ordered arrangement of atoms in a crystal must make it to act as a three-dimensional grating. Thus the three dimensional crystal would be suitable for the diffraction of X-rays and diffraction pattern so obtained can give the information about the crystal structure. Later on, WL Bragg presented a suitable explanation of X-ray diffraction by crystal. Now x ray diffraction techniques have become an important tool study the crystal structure.

2.2 OBJECTIVES

After studying this unit, you should be able to-

- X ray diffraction by a crystal
- X ray diffraction methods
- understand reciprocal lattice, Bragg's law in reciprocal system.
- calculate primitive translation vectors of reciprocal lattice.
- reciprocal lattice of sc, bcc, fcc.
- Brillouin zones
- solve problems based on crystal diffraction and Bragg's law.

2.3 X RAY DIFFRACTION AND BRAG'S LAW

When a beam of x rays is incident on a crystal, under certain condition diffraction takes place. The diffraction occurs when the incident rays are reflected by the atoms on the different parallel planes, and these reflected rays interfere constructively and make diffraction pattern. By analyzing the diffraction patterns we can find out the lattice parameters, size, shape, orientation of crystal, inter planner distance etc. In 1913, Bragg presented a method to explain the diffraction of x ray beam.

Consider a set of parallel planes of the crystal, and each plane is separated by spacing d . The crystal acts as a series of parallel reflecting planes. When a parallel beam of X-rays strikes on the crystal, each atom in the crystal plane scatters the X- ray in all directions. Since X-rays can penetrate the crystal, there would be partial reflection from every plane. The rays reflected from various planes will interfere constructively if they are in same phase. The diffraction occurs when a constructive interference of radiation reflected from two successive crystal plane takes place.

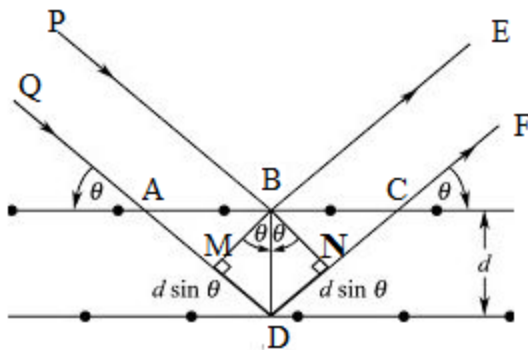

Figure2.1: Bragg's diffraction by crystal planes

To find out the diffraction condition, we consider the incident ray makes an angle θ with crystal plane, and the reflected ray also make an angle θ with the plane as shown in figure 2.1. The path difference between rays PBE and QDF can be given as

$$\Delta = MD + DN = 2MD = 2d \sin \theta$$

For constructive interference the path difference should be integral multiplication of $n\lambda$ therefore

$$2d \sin \theta = n\lambda$$

This is Bragg's law. The condition occurs only at certain values of λ and θ . Thus by observing the parameters λ and θ by experiment we can determine the crystal lattice spacing, size, shape, orientation and we can study the crystal structure.

Example 1: An electron is accelerated through a potential difference of 1kV and diffracted through a crystal. The first reflection maxima observed when the glancing angle is 10° . Find out the interplaner spacing of the crystal.

Solution: The wavelength of electron beam accelerated through potential difference 1kV is

$$\lambda = \frac{h}{\sqrt{2meV}} = \frac{6.67 \times 10^{-34}}{\sqrt{2 \times 9.1 \times 10^{-31} \times 1.6 \times 10^{-19} \times 1000}} = 0.38 \times 10^{-10} \text{m}$$

Now using Bragg's equation- $2 d \sin \theta = n \lambda$

or
$$d = n \lambda / 2 \sin \theta = 1 \times 0.38 \times 10^{-10} / (2 \times \sin 10^\circ)$$

$$= 1.11 \times 10^{-10} \text{ m} = 1.11 \text{ \AA}$$

Example 2: X-rays of wavelength 0.36 \AA diffracted in a Bragg spectrometer at an angle of $4^\circ 48'$. Determine the effective value of atomic spacing.

Solution: Given- $\lambda = 0.36 \text{ \AA} = 0.36 \times 10^{-10} \text{ m}$, $\theta = 4^\circ 48'$

Now using Bragg's equation- $2 d \sin \theta = n \lambda$

or
$$d = n \lambda / 2 \sin \theta = 1 \times 0.36 \times 10^{-10} / (2 \times \sin 4^\circ 48')$$

$$= 2.15 \times 10^{-10} \text{ m} = 2.15 \text{ \AA}$$

Self Assessment Question (SAQ) 1: what is diffraction? How a crystal diffracts X-rays?

2.4 DIFFRACTION METHODS

We know that the diffraction occurs whenever the Bragg's condition is satisfied. In general when monochromatic x ray beam falls on a single crystal, for arbitrary setting x rays will not produce any diffraction pattern. But some way if we continuously vary wavelength (λ) or diffraction angle (θ) then at a particular setting of single crystal, the Bragg's condition satisfies, and diffraction occurs. The ways, in which these quantities vary, there are three diffraction method as given below:

Method	Wavelength	Angle	Specimen type
Laue Method	Variable	Fixed	Single crystal
Rotating crystal method	Fixed	Varying	Single crystal
Powder method	Fixed	Variable	powder

2.4.1 Laue Diffraction Method

Laue method was the first diffraction methods, because it has been developed first, ever used till today and it reproduces Von Laue's original experiment. It is mainly used to determine the orientations of large single crystals. While radiations is reflected or transmitted through a fixed single crystal, the Bragg's angle that is fixed in this particular case, for every set of planes, in the crystal and each set picks out and diffracts that particular wavelength which satisfies the Bragg's law for the particular values of d and θ . We are having the sample which is single crystals, so the X-rays are coming and incident beam maybe the diffracted. In this particular region on to the particular film we are getting some kinds of white spots over there, which are the different diffraction picks, or maybe the spots. Each diffracted beam has a different wavelength and some selected wavelength of the incident beam of X ray radiations are reflected for some value of d and θ .

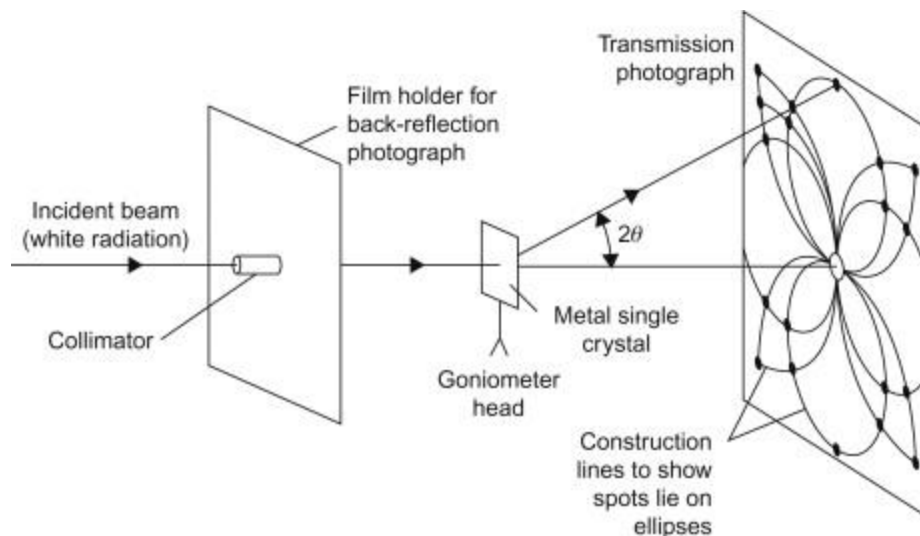

Figure 2.2: Laue diffraction method

The positions of any Laue spot can be alter early, if the wavelength of the diffracted beam changed. Suppose we are having the two crystals having the same orientations and same crystal structure, but of different lattice parameter, will produced the same identical Laue patterns. We are having that incident beam, then we are having collimators, then it is going through the samples then rays has been diffracted and then on the film it is giving some kind of spot pattern.

Now we know that the Elastic Scattering

$$|\mathbf{K}| = |\mathbf{K}'|$$

$$\text{where } \mathbf{K} = \frac{\mathbf{S}_0}{\lambda} = \text{incident wave vector}$$

$$K' = \frac{S}{\lambda} = \text{diffracted wave vector}$$

S_0 = incoming X ray beam

S = Scattered X ray beam

The Laue's theory states that for diffractions the differences in the two wave vectors must be equal to a reciprocal lattices vector σ^* .

$$K' - K = \sigma^*$$

Now from this particular case, we are going to discuss about the Ewald sphere. The Ewald sphere is a pictorial way to show the diffraction condition. We construct a sphere which is known as the Ewald constructions as shown in figure 2.3. In this figure an incoming beam S_0 is coming then after passing through single crystal it has be diffracted and it is going to the S and it has falling on to the sphere in a particular point.

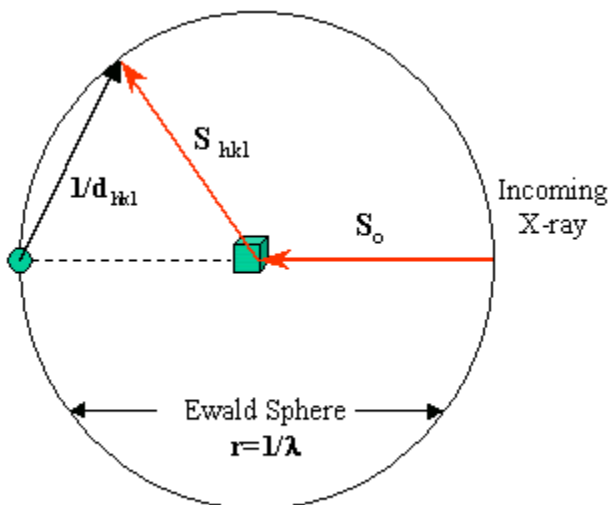

Figure 2.3: Ewald sphere

So generally the Ewald sphere is a virtual or imaginary sphere whose radius is $1/\lambda$. The geometrical construction of Eward sphere provides the relationship between the orientations of a crystal and the directions of the beams diffracted by it. If the origin of reciprocal space is placed at the tip of incident beam then diffractions will occur only for those reciprocal lattice points that lie on the surface of the Ewald sphere as shown in figure 2.3.

2.4.2 Rotating Crystal Method

In rotating crystal method, a single crystal is mounted at a point on the axis of a cylindrical shape in such a way that the monochromatic x-rays strike perpendicular on the crystal. A cylindrical photographic film is placed around the crystal and crystal is rotated about the axis in a chosen direction. The axis of the photographic film is same as the axis of rotation of the Crystal. As crystal rotates, sets of lattice points come at the positions that are suitable for Bragg's diffraction. At some particular positions, lattice points correctly at Bragg angle for reflection of X-Ray beam, and at this instant diffraction beam will be formed. The diffracted beam is located on the surface of

imaginary cone when the film is laid out from the cylinder, flat it, the diffraction spots lies on the film in horizontal lines.

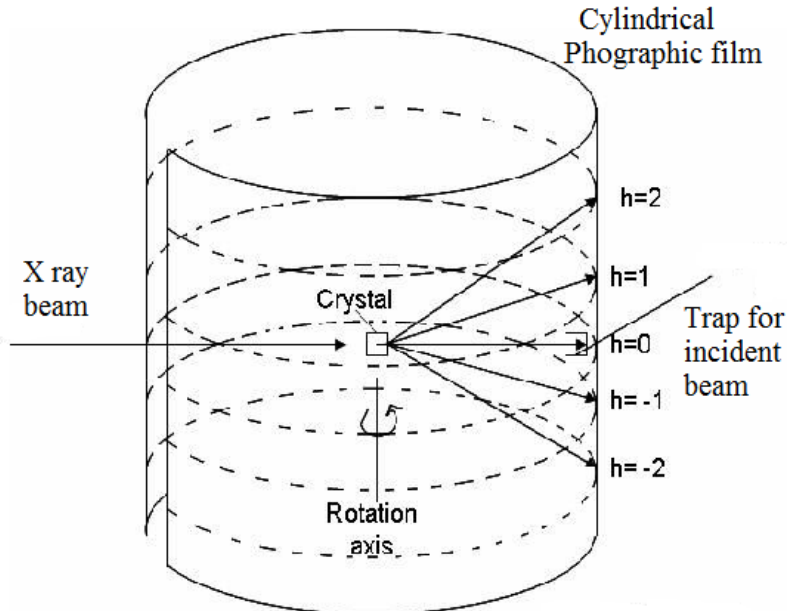

Figure 2.4: Rotating crystal method

2.4.2.1: Crystal structure determination by the rotating crystal method

By recording the diffraction pattern, both angle and intensities for various crystal orientations can be obtained and the shape and size of unit cell of the crystal and arrangement of atoms inside the crystal can be determined. If the wavelength of X-Rays is λ and angle of diffraction is Θ at which a reflection occurs, the inter-planar spacing d can be determined by using Bragg's law as given below:

$$2d \sin \Theta = n\lambda$$

$$d = \frac{a}{\sqrt{(h)^2 + (k)^2 + (l)^2}}$$

2.4.3 Powder Method

As we know in powder method, wavelength of X-ray, λ is fixed but angle of incident x ray with crystal plan Θ variable. The sample consists of powder and it consists of large number of crystallites with various orientations. The crystal to be examined is reduced to a very fine powder and placed in a beam of monochromatic X-rays. When the X-rays falls on the sample, tiny crystal are oriented in random directions with respect to the incident X rays and some of the crystals will be correctly oriented with the X-ray beam and give diffraction pattern. For example, in particular planes, say, (100) planes can reflect the incident beam and other crystals will be correctly oriented for the other planes say (110) and so on. Thus in Powder method every set of lattice planes will be capable of reflection as all the orientations of crystal are available on the sample.

Powder method is used to determine the value of lattice parameters accurately which define the unit cell of crystal. When monochromatic x-ray beam is directed on a single crystal then only one or two diffracted beams are observed. But if the sample consists of many randomly oriented single crystals, the diffraction beams are seen to lie on the surface of several cones. The cones may merge in all directions, in forward and backwards as shown in figure 2.6. In case of powder method, a sample has hundreds of tiny crystals show that the diffraction beam form continuous cones. A circle of film is used to record the diffraction pattern. Each cone intersects this film gives diffraction line. The lines are seen as arc on the as shown in figure 2.7.

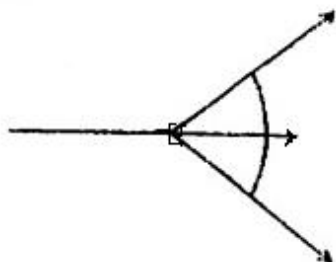

Figure 2.5: Diffraction by a single crystal

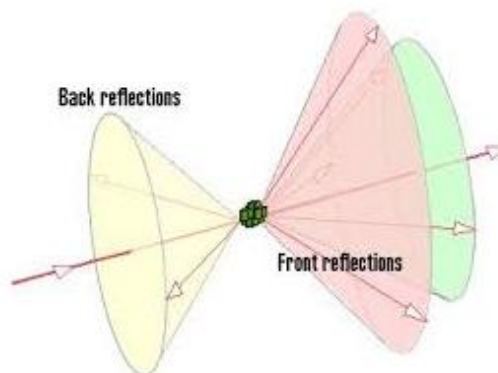

Figure 2.6: Diffraction by a powdered crystal

2.4.3.1 Powder diffraction film

The cones of diffracted radiation intersect the cylindrical strips of film inline or are and when the strips are unrolled and make it flat, the strip shows diffraction lines as shown in figure 2.8. We can see that each diffraction line is made up of a large number of small spots. Each line is formed by a separate crystal particle. The spots lying so closer together and they appear as a continuous line. The lines are generally curved as cone of diffracted rays cut the strip a curved line but at $2\theta = 90^\circ$, the line will be straight. From the measured position of a given diffraction line on the film, angle θ can be determined. If we know the wavelength λ of X-Rays, we can calculate the inter planar spacing (d) of reflecting lattice planes. Figure 2.8 shows the different positions of lines corresponding to different lattice planes.

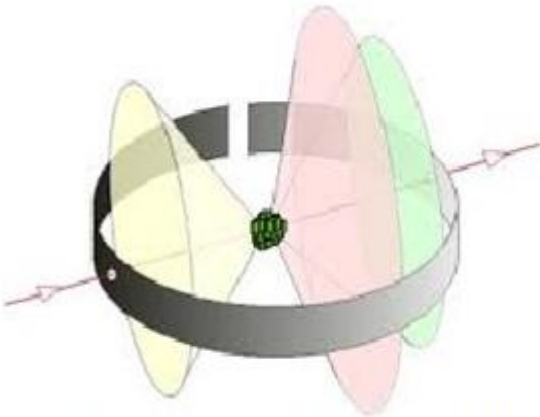

Figure 2.7: circular strip of film to record diffracted rays

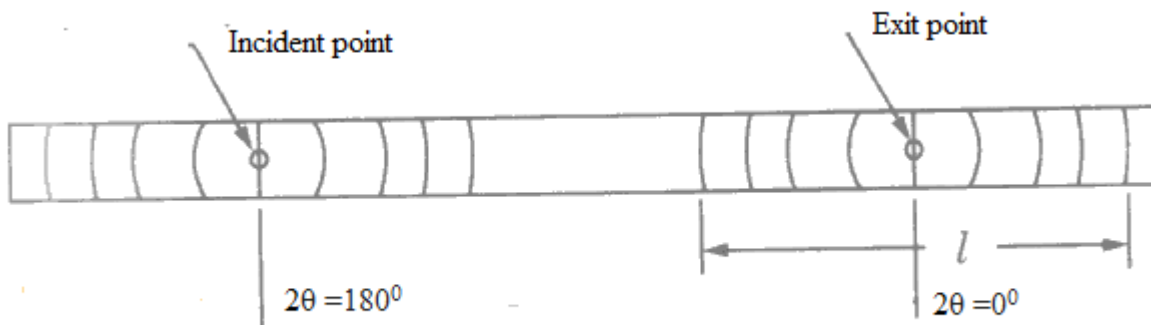

Figure 2.8: appearance of strip of photographic film

2.5 RECIPROCAL LATTICE SYSTEM

When we observe diffraction patterns, the diffraction spots form a picture of a crystal lattice. This periodic structure-like lattice is not a direct picture of a crystal but an image of the actual crystal. This is called a reciprocal lattice. In the reciprocal lattice, each lattice point corresponds to the reflection of a lattice point of a crystal plane. Simply, reciprocal lattice points are the inverse of actual lattice points. Thus, the distance in the reciprocal lattice system is $1/d$, where d is the distance corresponding to the actual distance in the actual crystal lattice. All the periodic points of the reciprocal lattice form a reciprocal lattice system. Such space is called reciprocal space or Fourier space. Fourier analysis is useful to form a theoretical background of the reciprocal lattice system. In a direct lattice system, the lattice vectors are denoted by $\mathbf{a}_1, \mathbf{a}_2, \mathbf{a}_3$ (or $\mathbf{a}, \mathbf{b}, \mathbf{c}$). Similarly, in the reciprocal lattice system, the reciprocal lattice vectors are denoted by $\mathbf{b}_1, \mathbf{b}_2, \mathbf{b}_3$ (or $\mathbf{a}^*, \mathbf{b}^*, \mathbf{c}^*$). We will develop relations between direct and reciprocal lattice vectors in the next section. Any vector in reciprocal space is called a reciprocal vector \mathbf{G} and can also be given as

$$\mathbf{G} = v_1 \mathbf{b}_1 + v_2 \mathbf{b}_2 + v_3 \mathbf{b}_3 \quad \text{where } v_1, v_2, v_3 \text{ are integer numbers.}$$

2.5.1 Construction of Reciprocal Lattice

For construction of a reciprocal lattice following steps can be taken.

1. Consider a crystal lattice in real space as shown in figure 2.9 and consider a plane (hkl). We know that (hkl) shows a set of parallel equidistance planes with interspacing d_{hkl} .
2. Now consider a normal on any arbitrary lattice point on the plane (hkl) and find out a point at distance $1/d_{hkl}$. This point is reciprocal lattice point. The array of all such point are called reciprocal lattice. In figure 2.9 if a_1, a_2, a_3 are lattice vector in real space, ABCD is a plane (101) then C' is reciprocal point, which is $1/d_{hkl}$ apart from the plane ABCD along direction normal to plane.

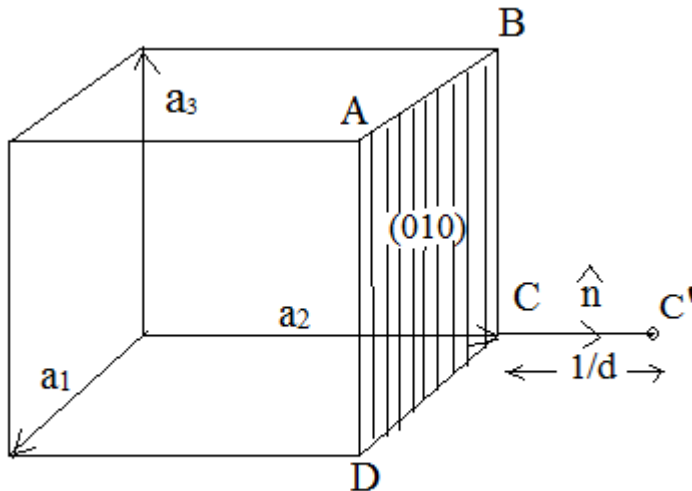

Figure 2.9 Reciprocal lattice points

Now consider a monoclinic crystal have lattice constants $a_1 \neq a_2 \neq a_3$ and $\alpha = \gamma = 90^\circ$; $\beta \neq 90^\circ$ as shown in figure 2.10. We construct a unit cell in which vectors a_1, a_3 are along the plane of paper and a_2 vector is perpendicular to this plane. Consider a plane (h0k) which makes intercepts at a_1, a_3 at point A and C, and this plane is parallel to axis a_2 . The normal to this plane is along the direction of plane containing vectors a_1, a_3 i.e. plane of paper as shown by vector OO' as shown in figure 2.11. If we go $1/d_{hkl}$ distance from the arbitrary plane (hkl), for example, perpendicular to line AC, along the direction perpendicular to plane (h0l) i.e. OO' , we get the reciprocal lattice point corresponding to point O.

We can extend the same manner to get other reciprocal lattice points as shown in figure 2.12. In this figure OA and OC represent two faces (sides) of monoclinic crystal. Line AC represents a plane (h0k) which is perpendicular along line AC. Now for reciprocal point, normal is drawn on planes (h0l) at a distance $1/d_{h0l}$. Similarly, we draw normal to all (hkl) planes and arranged the

points at distance $1/d_{hkl}$ in the direction of normals, the three dimensional reciprocal lattice is obtained. It can be seen that plane (200) have half the interplaner spacing with respect to plane (100) but reciprocal point (200) is twice far from the origin.

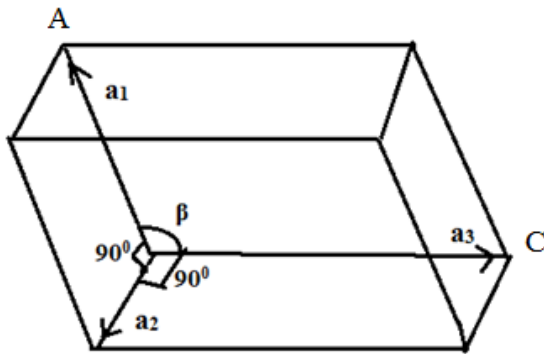

Figure 2.10: Monoclinic lattice point in real space

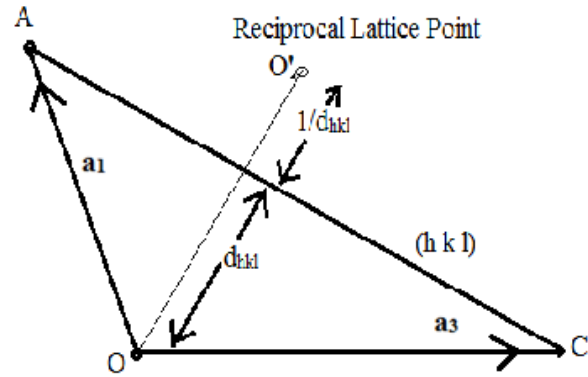

Figure 2.11: Reciprocal lattice point in real space for monoclinic crystal

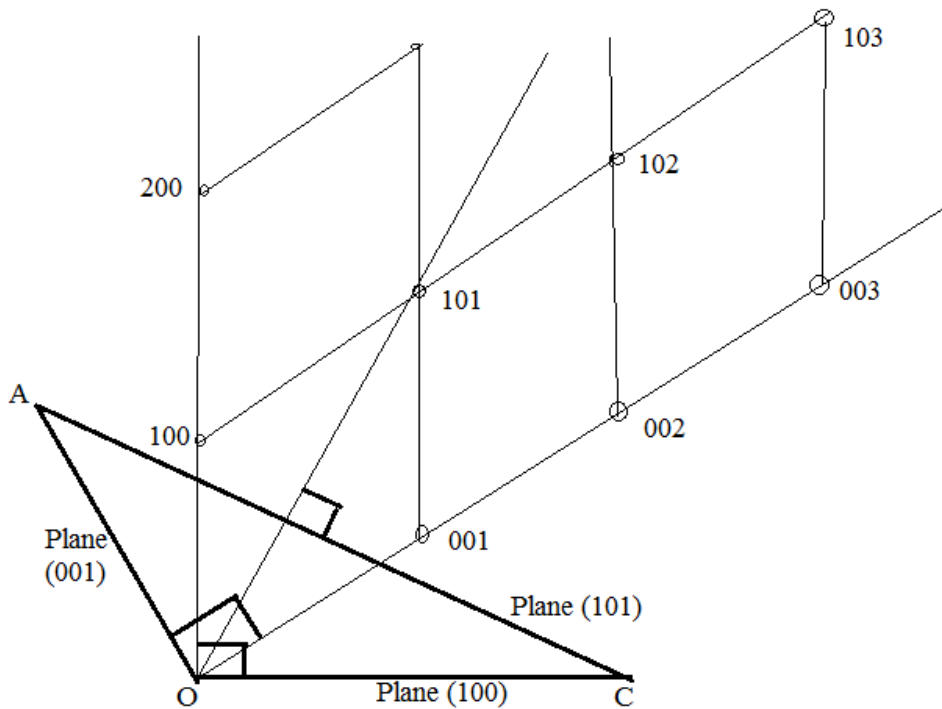

Figure 2.12: Reciprocal lattice points for monoclinic lattice in 2D

2.5.1 Reciprocal Lattice Vectors

Reciprocal lattice vector is defined as the vector has magnitude $1/d_{hkl}$ and direction perpendicular to the plane (h k l). Generally reciprocal lattice vector is denoted by

$$\sigma_{hkl} = \frac{1}{d_{hkl}} \hat{n} \quad \text{where } \hat{n} \text{ unit vector along the normal to (hkl)plane}$$

If lattice vectors of a crystal are denoted by $\mathbf{a}_1, \mathbf{a}_2, \mathbf{a}_3$ in direct lattice system and similarly in reciprocal lattice system, the reciprocal lattice vectors are denoted by $\mathbf{b}_1, \mathbf{b}_2, \mathbf{b}_3$ then the volume of crystal unit cell in direct lattice system can be given by

$$V = \text{area} \times \text{height} = \text{area} \times d_{hkl}$$

For simplest case if we choose plane (100) then

$$\frac{1}{d_{100}} = \frac{\text{area}}{V} = \frac{\mathbf{a}_2 \times \mathbf{a}_3}{[\mathbf{a}_1 \cdot \mathbf{a}_2 \times \mathbf{a}_3]}$$

$$\sigma_{100} = \frac{\mathbf{a}_2 \times \mathbf{a}_3}{[\mathbf{a}_1 \cdot \mathbf{a}_2 \times \mathbf{a}_3]}$$

The fundamental reciprocal lattice vector are defined as

$$\mathbf{b}_1 = \sigma_{100} = \frac{\mathbf{a}_2 \times \mathbf{a}_3}{[\mathbf{a}_1 \cdot \mathbf{a}_2 \times \mathbf{a}_3]}$$

Similarly

$$\mathbf{b}_2 = \sigma_{010} = \frac{\mathbf{a}_3 \times \mathbf{a}_1}{[\mathbf{a}_1 \cdot \mathbf{a}_2 \times \mathbf{a}_3]}$$

$$\mathbf{b}_3 = \sigma_{001} = \frac{\mathbf{a}_1 \times \mathbf{a}_2}{[\mathbf{a}_1 \cdot \mathbf{a}_2 \times \mathbf{a}_3]}$$

Since each reciprocal vector is orthogonal to two axis vectors of direct lattice thus

$$\mathbf{b}_1 \cdot \mathbf{a}_2 = \mathbf{b}_1 \cdot \mathbf{a}_3 = \mathbf{b}_2 \cdot \mathbf{a}_1 = \mathbf{b}_2 \cdot \mathbf{a}_3 = \mathbf{b}_3 \cdot \mathbf{a}_1 = \mathbf{b}_3 \cdot \mathbf{a}_2 = \mathbf{0}$$

Above relations are equally valid if we introduce 2π . Since in reciprocal lattice the wave vector is represented in term of 2π (as $\mathbf{k} = 2\pi/\lambda$). Thus the reciprocal vector are given as

$$\mathbf{b}_1 = 2\pi \frac{\mathbf{a}_2 \times \mathbf{a}_3}{[\mathbf{a}_1 \cdot \mathbf{a}_2 \times \mathbf{a}_3]}$$

$$\mathbf{b}_2 = 2\pi \frac{\mathbf{a}_3 \times \mathbf{a}_1}{[\mathbf{a}_1 \cdot \mathbf{a}_2 \times \mathbf{a}_3]}$$

$$\mathbf{b}_3 = 2\pi \frac{\mathbf{a}_1 \times \mathbf{a}_2}{[\mathbf{a}_1 \cdot \mathbf{a}_2 \times \mathbf{a}_3]}$$

Thus $\mathbf{b}_i \cdot \mathbf{a}_j = 2\pi \delta_{ij}$ where $\delta_{ij} = 1$ if $i = j$; $\delta_{ij} = 0$ if $i \neq j$

2.5.2 Reciprocal Lattice of Simple Cubic Crystal

Consider unit cell in a simple cubic crystal, primitive lattice vectors in direct lattice system are given by

$$\mathbf{a}_1 = a\hat{i}; \mathbf{a}_2 = a\hat{j}; \mathbf{a}_3 = a\hat{k}$$

Where $\hat{i}, \hat{j}, \hat{k}$ are unit vector along x y z Axis respectively. Now the reciprocal lattice vectors are given as

$$\mathbf{b}_1 = 2\pi \frac{\mathbf{a}_2 \times \mathbf{a}_3}{[\mathbf{a}_1 \cdot \mathbf{a}_2 \times \mathbf{a}_3]} = 2\pi \frac{a^2 \hat{j} \times \hat{k}}{a^3 \hat{i} \cdot \hat{j} \times \hat{k}} = \frac{2\pi}{a} \hat{i} \quad \text{where } [\mathbf{a}_1 \cdot \mathbf{a}_2 \times \mathbf{a}_3] \text{ is volume (V) of unit cell.}$$

$$\text{or } \mathbf{b}_1 = \frac{2\pi}{a} \hat{i}$$

$$\text{Similarly } \mathbf{b}_2 = \frac{2\pi}{a} \hat{j}$$

$$\text{And } \mathbf{b}_3 = \frac{2\pi}{a} \hat{k}$$

We can say that the unit cell of simple cubic lattice in reciprocal lattice space is again a cubic lattice, same as the direct space, but the cube edge is $\frac{2\pi}{a}$ in place of \mathbf{a} . Thus a simple cubic lattice of lattice parameter \mathbf{a} , transforms to a simple cubic lattice of lattice parameter $\frac{2\pi}{a}$ in reciprocal lattice system. Figure 2.13 and 2.14 show the simple cubic lattice in direct and reciprocal lattice system.

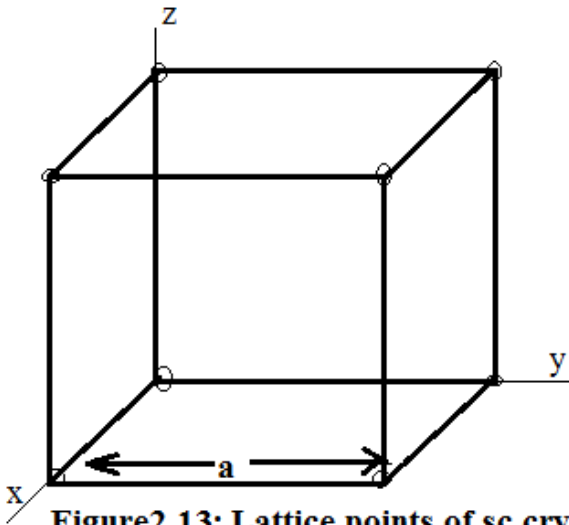

Figure 2.13: Lattice points of sc crystal in direct lattice

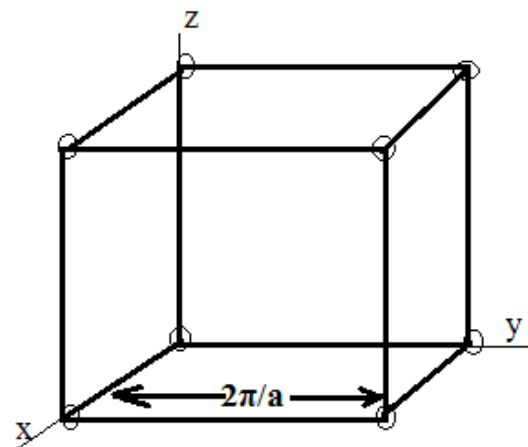

Figure 1.14 : lattice points of sc crystal in reciprocal lattice

2.5.3 Reciprocal Lattice of Body Centered Cubic Crystal

The primitive lattice vectors bcc crystal in direct lattice system is given as

$$\mathbf{a}_1 = \frac{a}{2}(\hat{i} + \hat{j} - \hat{k}); \mathbf{a}_2 = \frac{a}{2}(-\hat{i} + \hat{j} + \hat{k}); \mathbf{a}_3 = \frac{a}{2}(\hat{i} - \hat{j} + \hat{k})$$

Where $\hat{i}, \hat{j}, \hat{k}$ are unit vector along x y z Axis respectively. These vectors are shown in figure 2.15. Now the reciprocal lattice vectors are given as

$$\mathbf{b}_1 = 2\pi \frac{\mathbf{a}_2 \times \mathbf{a}_3}{[\mathbf{a}_1 \cdot \mathbf{a}_2 \times \mathbf{a}_3]} = 2\pi \frac{(a^2/4) (-\hat{i} + \hat{j} + \hat{k}) \times (\hat{i} - \hat{j} + \hat{k})}{(a^3/2)} = \frac{2\pi}{a} (\hat{j} + \hat{k})$$

$$\mathbf{b}_1 = 2\pi \frac{(a^2/4) 2(\hat{i} + \hat{j})}{(a^3/2)} = \frac{2\pi}{a} (\hat{j} + \hat{k})$$

$$\text{or } \mathbf{b}_1 = \frac{2\pi}{a} (\hat{j} + \hat{k})$$

$$\text{Similarly } \mathbf{b}_2 = \frac{2\pi}{a} (\hat{k} + \hat{i})$$

$$\text{And } \mathbf{b}_3 = \frac{2\pi}{a} (\hat{i} + \hat{j})$$

If we recall fcc crystal lattice the primitive vectors can be given as

$$\mathbf{a}_1 = \frac{a}{2}(\hat{i} + \hat{j}); \mathbf{a}_2 = \frac{a}{2}(\hat{j} + \hat{k}); \mathbf{a}_3 = \frac{a}{2}(\hat{k} + \hat{i})$$

Thus we can say that the unit cell of body centered cubic lattice in reciprocal lattice space is a face centered with lattice parameter $\frac{2\pi}{a}$. Figure 2.15 shows the body centered cubic lattice in direct and reciprocal lattice system.

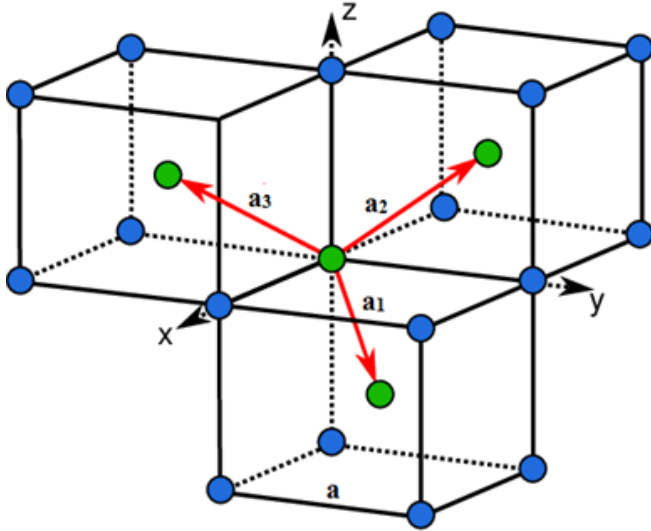

Figure 2.15 : Primitive lattice vectors of bcc crystal

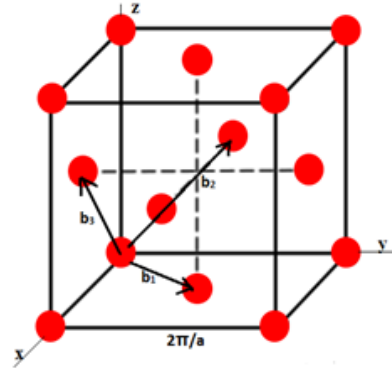

Figure 2.16 Reciprocal lattice to bcc crystal (i.e. fcc).

2.5.4 Reciprocal Lattice to fcc Crystal

Consider a unit cell of fcc crystal with lattice parameter a . The primitive lattice vectors for fcc crystal are given as

$$\mathbf{a}_1 = \frac{a}{2}(\hat{i} + \hat{j}); \quad \mathbf{a}_2 = \frac{a}{2}(\hat{j} + \hat{k}); \quad \mathbf{a}_3 = \frac{a}{2}(\hat{k} + \hat{i})$$

Figure 2.16 represents a fcc lattice. Reciprocal lattice vectors of this unit cell is given

$$\mathbf{b}_1 = 2\pi \frac{\mathbf{a}_2 \times \mathbf{a}_3}{[\mathbf{a}_1 \cdot (\mathbf{a}_2 \times \mathbf{a}_3)]} = 2\pi \frac{(a^2/4) (\hat{j} + \hat{k}) \times (\hat{i} + \hat{k})}{\frac{a^3}{8} [(\hat{i} + \hat{j}) \cdot ((\hat{j} + \hat{k}) \times (\hat{i} + \hat{k}))]} = 2\pi \frac{(a^2/4) (\hat{i} + \hat{j} - \hat{k})}{\frac{a^3}{4}}$$

$$\text{or } \mathbf{b}_1 = \frac{2\pi}{a} (\hat{i} + \hat{j} - \hat{k})$$

$$\text{Similarly } \mathbf{b}_2 = \frac{2\pi}{a} (-\hat{i} + \hat{j} + \hat{k})$$

$$\text{And } \mathbf{b}_3 = \frac{2\pi}{a} (\hat{i} - \hat{j} + \hat{k})$$

Thus the reciprocal lattice to fcc in the form of bcc lattice with lattice parameter to $\frac{2\pi}{a}$. Now it is clear that reciprocal of bcc is fcc, and reciprocal of fcc is again bcc. Therefore figure 2.15 can be considered as reciprocal lattice to fcc.

2.6 DIFFRACTION CONDITION IN RECIPROCAL LATTICE

In direct lattice system, diffraction takes place when the condition $2d \sin \theta = n\lambda$ is satisfied. This condition can also be obtained in reciprocal lattice system. We know, the reciprocal points are the points $1/d_{hkl}$ distant along a normal to crystal plane $(h k l)$. Now consider a reciprocal lattice space which has a large number of such reciprocal lattice points corresponding to different plans as shown in figure 2.17. Take a Reciprocal lattice point O as a centre, we draw a circle of radius $1/\lambda$ which is called Eward circle in two dimensional space, and in three dimension it is called Eward sphere. Eward stated that whenever a beam of x rays coming in the direction OA and strikes at point O, the centre of circle, and if the beam diffracted in the direction OB and passes through any another lattice point B on the circle, then the Bragg diffraction takes place.

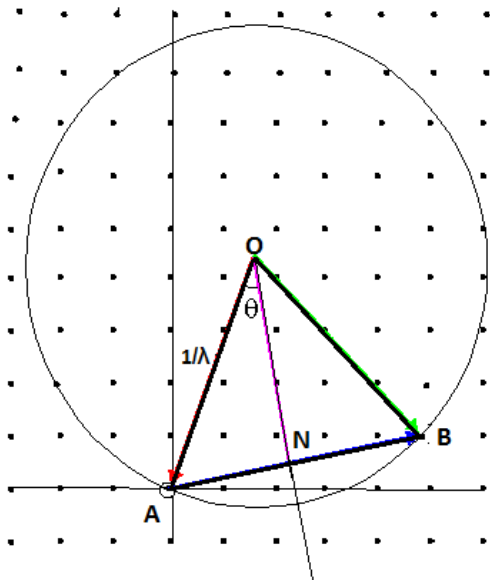

Figure 2.17: Eward circle in reciprocal lattice system

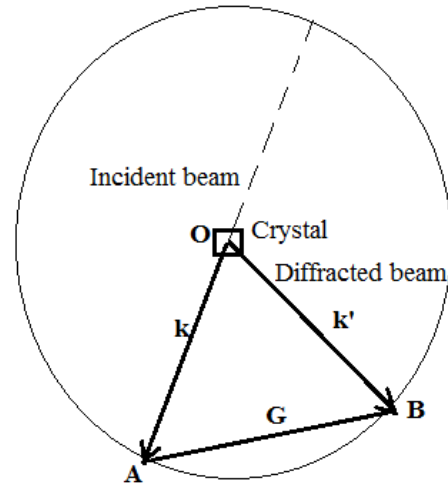

Figure 2.18: Diffraction in reciprocal lattice system

Support an x-ray beam is coming in the direction of OA, strike at a lattice point O where a crystal is placed as shown in figure 2.18 and OA represents the incident wave vector \mathbf{k} in reciprocal lattice system. The incident wave strikes at point O, the diffracted x ray passes through another lattice point B on the circle then Bragg diffraction occurs. Thus the reciprocal vector $\mathbf{AB} = \mathbf{G}$ can be given as

$$\mathbf{AB} = \mathbf{G} = v_1 \mathbf{b}_1 + v_2 \mathbf{b}_2 + v_3 \mathbf{b}_3 \quad \text{where } v_1, v_2, v_3 \text{ are integer numbers.}$$

$\mathbf{b}_1, \mathbf{b}_2, \mathbf{b}_3$ are reciprocal lattice primitive vectors. If we draw a perpendicular bisector of a vector AB, then it passes through point N where ON is nothing but plane of diffraction $(h k l)$ which is

perpendicular to plane of paper. We know that the separation between two reciprocal planes is d_{hkl} then distance between points A and B in reciprocal space can be given as:

$$AB = \frac{n}{d_{hkl}}$$

Where n is integer number called Common Factor.

Similarly by geometry

$$AB = 2AN = 2OA \cdot \sin \theta = \frac{2 \sin \theta}{\lambda}$$

using above two expressions for a AB

$$\frac{n}{d_{hkl}} = \frac{2 \sin \theta}{\lambda} \quad \text{or} \quad 2d \sin \theta = n\lambda$$

This is nothing but diffraction condition in direct lattice system. Thus in reciprocal lattice system, diffraction occurs when an x-ray coming along a direction OA, strikes on a point O, and after diffraction at this point O, diffracted ray passes through any another point (say B) situated on the same Eward circle.

Now we find out the diffraction condition in reciprocal lattice system. We know that in reciprocal space (Fourier space) the lattice parameter is denoted by wave vector $\mathbf{k} = \frac{2\pi}{\lambda}$. Figure 2.18 is the simplified representation of diffraction in reciprocal lattice system shown by figure 2.17. Now as shown in figure

$$\mathbf{OA} + \mathbf{AB} = \mathbf{BO}$$

$$\mathbf{K} + \mathbf{G} = \mathbf{K}' \quad \text{or} \quad \mathbf{K} - \mathbf{K}' = \mathbf{G} \quad \text{or} \quad \Delta\mathbf{K} = \mathbf{G}$$

This is diffraction condition in reciprocal lattice system, where \mathbf{K} is incident wave vector, \mathbf{K}' is scattered wave vector and \mathbf{G} is reciprocal lattice vector. Since OA and OB are radius of the Eward circle and magnitude of both vectors are same only direction are different thus

$$\begin{aligned} |\mathbf{OA}|^2 &= |\mathbf{OB}|^2 \\ |\mathbf{K}|^2 &= |\mathbf{K} + \mathbf{G}|^2 \\ \mathbf{G}^2 + 2\mathbf{K}\mathbf{G} &= 0 \end{aligned}$$

This is another representation of diffraction condition in reciprocal lattice system.

2.7 BRILLOUIN ZONES

In direct lattice system we defined Wigner Seitz cell which is nothing but a type of unit cell constructed by the area enclosed by perpendicular bisectors of nearest neighbours. Similarly if we construct a unit cell by area enclosed by perpendicular bisectors of nearest neighbours reciprocal

lattice points that is called Brillouin zone. Figure 2.19 shows the first Brillouin zone and second Brillouin zones of a two dimensional lattice. In this figure, we have considered a two dimensional lattice space with a large number of lattice point, and O is an arbitrary point as origin. Now we draw perpendicular bisectors AB, BC, CD, DA of first nearest neighbor points, then the area enclosed by these perpendicular bisectors, i.e. ABCD is called first Brillouin zone. Similarly, the areas enclosed by the perpendicular bisectors of second nearest neighbours, EFGH, give the second Brillouin zone.

There are also third, *etc.*, Brillouin zones, corresponding to a sequence of disjoint regions (all with the same volume) at increasing distances from the origin, but these are used less frequently. As a result, the *first* Brillouin zone is often called simply the *Brillouin zone*. In general, the n -th Brillouin zone consists of the set of points that can be reached from the origin by crossing exactly $n - 1$ distinct Bragg planes. A related concept is that of the irreducible Brillouin zone, which is the first Brillouin zone reduced by all of the symmetries in the [point group](#) of the lattice (point group of the crystal). The concept of a Brillouin zone was developed by [Léon Brillouin](#) (1889–1969), a French physicist.

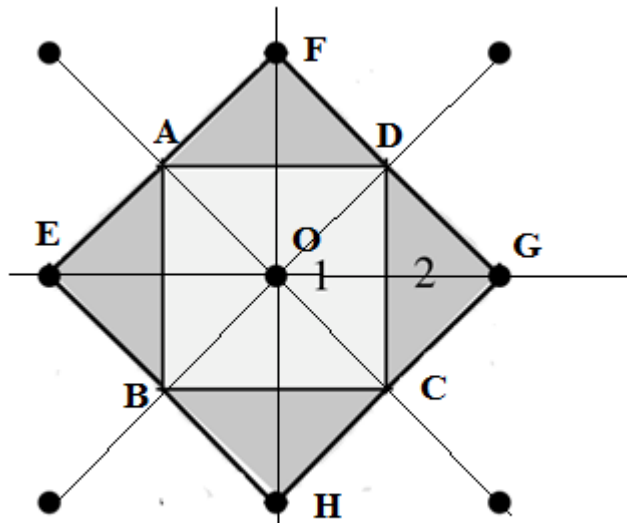

Figure 2.19: First and second Brillouin zone in 2D space.

In three dimensional space, Brillouin zone is the minimum volume under perpendicular bisectors of Bragg planes in reciprocal lattice space. Brillouin zone can also be understood by Eward construction. According to Eward construction, Bragg diffraction occurs for all possible value of wave vector \mathbf{K} for which condition $\mathbf{G}^2 + 2\mathbf{K}\mathbf{G} = 0$ satisfies. A Brillouin zone is the locus of all such values of \mathbf{K} in reciprocal lattice system for which Bragg diffraction occurs. The importance of the Brillouin zone stems from the Bloch wave description of waves in a periodic medium, in which it is found that the solutions can be completely characterized by their behavior in a single Brillouin zone. Figure 2.20 and 2.21 shows the Brillouin zone of bcc and fcc crystal.

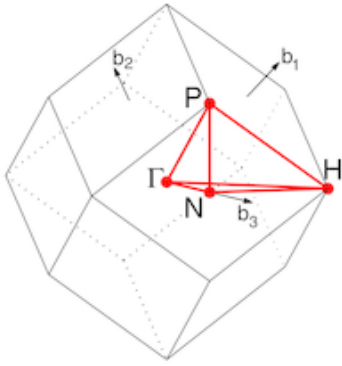

Figure 2.20: Brillouin zone of bcc crystal.

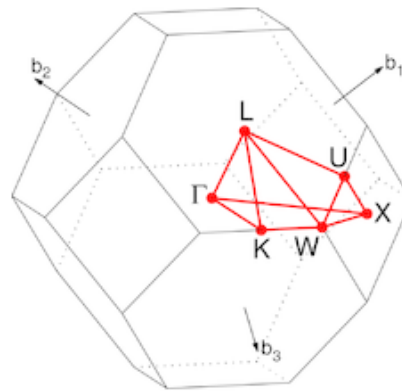

Figure 2.21: Brillouin zone of fcc crystal.

Several points of high symmetry are of special interest – these are called critical points.

Symbol	Description
Γ	Center of the Brillouin zone
Simple cube	
M	Center of an edge
R	Corner point
X	Center of a face
Face-centered cubic	
K	Middle of an edge joining two hexagonal faces
L	Center of a hexagonal face
U	Middle of an edge joining a hexagonal and a square face
W	Corner point
X	Center of a square face
Body-centered cubic	
H	Corner point joining four edges
N	Center of a face
P	Corner point joining three edges
Hexagonal	
A	Center of a hexagonal face
H	Corner point
K	Middle of an edge joining two rectangular faces
L	Middle of an edge joining a hexagonal and a rectangular face
M	Center of a rectangular face

2.8 SUMMARY

In this unit we studied about X-ray diffraction by crystal, Bragg's law, different method of diffraction, reciprocal lattice, and learn about the determination of crystal structure with the help of crystal diffraction.

1. The diffraction occurs when the incident rays are reflected by the atoms on the different parallel planes, and these reflected rays interfere constructively and make diffraction pattern. By analyzing the diffraction patterns we can find out the lattice parameters, size, shape, orientation of crystal, inter planner distance etc.

2. Bragg's law

$$2d \sin \theta = n\lambda$$

The condition occurs only at certain values of λ and θ . Thus by observing the parameters λ and θ by experiment we can determine the crystal lattice spacing, size, shape, orientation and we can study the crystal structure.

3. Diffraction method as given below:

Method	Wavelength	Angle	Specimen type
Laue Method	Variable	Fixed	Single crystal
Rotating crystal method	Fixed	Varying	Single crystal
Powder method	Fixed	Variable	powder

4. The Laue's theory states that for diffractions the differences in the two wave vectors must be equal to a reciprocal lattices vector σ^* .

$$K' - K = \sigma^*$$

The Ewald sphere is a pictorial way to show the diffraction condition.

5. In rotating crystal method, a single crystal is mounted at a point on the axis of a cylindrical shape in such a way that the monochromatic x-rays strike perpendicular on the crystal. By recording the diffraction pattern, both angle and intensities for various crystal orientations can be obtained and the shape and size of unit cell of the crystal and arrangement of atoms inside the crystal can be determined.

6. In case of powder method a sample has hundreds of tiny crystals, show the diffraction beam form continuous cones. A circle of film is used to record the diffraction pattern. Each cone intersects this film gives diffraction line.

7. When we observe diffraction patterns, the diffraction spot form a picture of crystal lattice. This periodic structure like lattice is not direct picture of crystal but image of actual crystal. This is called **reciprocal lattice**. In the reciprocal lattice, each lattice point is corresponding to reflection of lattice point of crystal plane. Simply reciprocal lattice points are inverse of actual lattice points.

8. Fundamental reciprocal lattice vector are defined as

$$\begin{aligned} \mathbf{b}_1 &= 2\pi \frac{\mathbf{a}_2 \times \mathbf{a}_3}{[\mathbf{a}_1 \cdot \mathbf{a}_2 \times \mathbf{a}_3]} \\ \mathbf{b}_2 &= 2\pi \frac{\mathbf{a}_3 \times \mathbf{a}_1}{[\mathbf{a}_1 \cdot \mathbf{a}_2 \times \mathbf{a}_3]} \\ \mathbf{b}_3 &= 2\pi \frac{\mathbf{a}_1 \times \mathbf{a}_2}{[\mathbf{a}_1 \cdot \mathbf{a}_2 \times \mathbf{a}_3]} \end{aligned}$$

9. For simple cubic crystal, primitive lattice vectors in direct lattice system is given by

$$\mathbf{a}_1 = a\hat{i}; \mathbf{a}_2 = a\hat{j}; \mathbf{a}_3 = a\hat{k}$$

The reciprocal lattice vectors are

$$\text{or } \mathbf{b}_1 = \frac{2\pi}{a}\hat{i}; \mathbf{b}_2 = \frac{2\pi}{a}\hat{j}; \mathbf{b}_3 = \frac{2\pi}{a}\hat{k}$$

9. For bcc crystal, primitive lattice vectors in direct lattice system is given as

$$\mathbf{a}_1 = \frac{a}{2}(\hat{i} + \hat{j} - \hat{k}); \mathbf{a}_2 = \frac{a}{2}(-\hat{i} + \hat{j} + \hat{k}); \mathbf{a}_3 = \frac{a}{2}(\hat{i} - \hat{j} + \hat{k})$$

The reciprocal lattice vectors are

$$\mathbf{b}_1 = \frac{2\pi}{a}(\hat{j} + \hat{k}); \mathbf{b}_2 = \frac{2\pi}{a}(\hat{k} + \hat{i}); \mathbf{b}_3 = \frac{2\pi}{a}(\hat{i} + \hat{j})$$

10. The primitive lattice vectors for fcc crystal are given as

$$\mathbf{a}_1 = \frac{a}{2}(\hat{i} + \hat{j}); \mathbf{a}_2 = \frac{a}{2}(\hat{j} + \hat{k}); \mathbf{a}_3 = \frac{a}{2}(\hat{k} + \hat{i})$$

The reciprocal lattice vectors are

$$\mathbf{b}_1 = \frac{2\pi}{a}(\hat{i} + \hat{j} - \hat{k}); \mathbf{b}_2 = \frac{2\pi}{a}(-\hat{i} + \hat{j} + \hat{k}); \mathbf{b}_3 = \frac{2\pi}{a}(\hat{i} - \hat{j} + \hat{k})$$

Thus the reciprocal lattice to bcc is fcc, and reciprocal of fcc is again bcc.

11. Diffraction condition in reciprocal lattice system

$$\mathbf{K} - \mathbf{K}' = \mathbf{G} \quad \text{or} \quad \Delta\mathbf{K} = \mathbf{G} \quad \text{and} \quad \mathbf{G}^2 + 2\mathbf{K}\mathbf{G} = 0$$

12. A unit cell constructed by area enclosed under perpendicular bisectors of nearest neighbours reciprocal lattice points is called Brillouin zone. In three dimensional space, Brillouin zone is the minimum volume under perpendicular bisectors of Bragg planes in reciprocal lattice space.

Self Assessment Questions (SAQs):

SAQ1: If $\lambda > 2d$ then explain the solution of Bragg's equation.

SAQ 2: Are the Laue spots show diffraction property of X-rays?

SAQ: What will be the relation between volume of unit of reciprocal lattice and the volume of unit in direct lattice?

2.9 GLOSSARY

Diffraction- bending of waves at the corners of the object in their path whose size is one of the order of wavelength of wave.

Transmitted- passed on, sent out.

Reciprocal lattice- The diffraction image of actual crystal lattice.

Wigner Seitz cell- A type of unit cell constructed by the area enclosed by perpendicular bisectors of nearest neighbours.

Brillouin zone – A unit cell constructed by area enclosed under perpendicular bisectors of nearest neighbours reciprocal lattice points

2.10 REFERENCES

C Kittel, Introduction to Solid State Physics 7th Edition, John Wiley and Sons, Singapore

H C Gupta, Solid State Physics, Vikas Publication House, New Delhi

Arun Kumar, Introduction to Solid State Physics, PHI Learning Private Limited, New Delhi

2.11 SUGGESTED READIN

1. OS Pillai, Solid state *Physics*, New Age International(P) limited, New Delhi
2. Solid State Devices, B.Somanathan Nair, S.R. Deepa, PHI Learning Private Limited, New Delhi.
3. Fundamentals of Solid State Physics, B.S. Saxena, R.C. Gupta, P.N. Saxena, Pragati Prakashan Meerut.

2.12 TERMINAL QUESTIONS**2.17.1 Long Answer Type Questions**

1. Describe Laue's experiment for X-rays diffraction. Give its significance.
2. What is reciprocal lattice? How we construct a reciprocal lattice? Give its properties.

3. Describe powder method for the determination of crystal structure.
4. What is Ewald's construction? How does it help in the explanation of x ray diffraction?
5. Obtain the relation between direct lattice vector and reciprocal lattice vectors.
6. What are Brillouin zones? Construct first two Brillouin zone of a two dimensional lattice. Obtain the volume of first Brillouin zone.

2.17.2 Short Answer Type Questions

1. Describe Bragg's law for x ray diffraction. And give its significance.
2. What is reciprocal lattice?
3. Show that reciprocal of fcc is bcc.
4. How will you use Bragg's law to determine the crystal structure?
5. Give the types of diffraction methods.
6. Explain Laue pattern.
7. Discuss Ewald's construction. Give its importance and uses.
8. Write Bragg's law in terms of reciprocal lattice vectors?
9. What are Brillouin zones?
10. A set of crystal planes reflects X-rays of wavelength 1.32 \AA at a glancing angle of $9^\circ 30'$. Determine the possible spacing of this set of planes.

UNIT 3**CRYSTAL BONDING**

Structure

3.1 Introduction

3.2 Objectives

3.3 Bonding in solids

3.3.1 Cohesive energy

3.4 Crystal of inert gas solids

3.4. 1. Vander Waal -Landon interaction

3.5 Ionic crystal and ionic solids

3.5.1 Electrostatic and Madulung energy

3.6 Covalent crystal and covalent bonding

3.7 Metallic crystal and Metallic bonding

3.8 Intermolecular bond

3.9 Hydrogen bond

3.10 Summary

3.11 Glossary

3.12 References

3.13 Suggested Readings

3.14 Terminal Questions

3.1. INTRODUCTION

In previous unit we have discussed the classification of crystal on the basis of structure. We have also seen seven types of crystal systems and geometrical structures of different crystals. The physical properties of solids depend on their crystal structure and bonding. In this unit, now we will discuss about crystal bonding. Bonding of molecules of solids is also an important aspect for the understanding of solid. Strong attractive forces among the atoms or molecules hold the crystal together. This force is nothing but attractive electrostatic interaction between negative charge electrons and positive charge nuclei which is entirely responsible for cohesion of solids. Inside a crystal, the atoms are arranged in a very short distance, thus the main force is electrostatic. The gravitational force is negligible and magnetic forces have a weak effect and nuclear force does not operate among the atoms in this range. This unit also deals with cohesive energy which is the energy that must be added to the crystal to separate its components into neutral free atoms at rest at infinite separation. Depending on the nature of constituents of a crystal, there are different types of bonding like ionic, covalent, hydrogen bonding and metallic bonding. In this unit we will understand these aspects of bonding in detail.

3.2. OBJECTIVE

After reading this unit we will able to understand:

- Cohesive energy of crystalline solids
- Lattice energy
- Different types of bonding
- Vander Waals bonding
- Ionic bonding
- Covalent bonding
- Metallic bonding and hydrogen bonding.

3.3. BONDING IN SOLIDS

Solids are basically aggregates of atoms. For the existence of solid there is a binding force which binds the atoms in molecules, and molecule in solid. In solids, the interatomic forces are of two types, one is repulsive to prevent the atoms for merging on each other, and the other is attractive to keep them close. Both the attractive and repulsive forces depend on the interatomic separation (generally denoted by r). At a particular separation called equilibrium separation r_0 , the force of repulsion is equal to force of attraction. At this position the potential energy of system becomes minimum and crystal becomes stable. Figure 3.1 show the variation of interatomic force (denoted by F) with interatomic separation r . The potential energy or internal energy of a solid or material is the sum of all individual energies of atoms plus their interaction energies. The potential energy

is sum of repulsive and attractive energy of atoms which again depends on the interatomic separation r . At equilibrium position $r = r_0$ the potential energy $U(r)$ becomes minimum as shown in figure 3.2 and solid becomes stable. For example the NaCl crystal is more stable than Na and Cl atoms. Thus the energy of NaCl crystal is less than the individual energy of Na and Cl atoms. This means the energy of crystal is less than that the energy of individual free atoms. The difference in the energies is nothing but binding energy. Thus binding energy is defined as the energy required to keep the atoms or molecules in a solid to an infinite separation.

Similarly, the cohesive energy of a crystal is also defined as the energy required for separating its components (ion or molecule) into neutral free atoms at infinite separation with some electronic configuration. For example, the cohesive energy of nitrogen solid is the energy required to separate nitrogen molecules from nitrogen solid as nitrogen molecules are the component of solid nitrogen. Similarly, in case of NaCl crystal, the cohesive energy of NaCl is the energy required to separate the NaCl solid into isolated Na^+ and Cl^- ions, instead of atoms, as ions are the components of NaCl crystal. In case of metallic solid, the cohesive energy of metallic solids is the energy required to separate its components (neutral atoms) into neutral atoms of metals. Sometime we use term binding energy defined as the energy required to separate a particle from a system of particles. This term is generally used in sub atomic particle like electron (e), proton (p) or neutron (n) etc. in atomic nucleus. In crystal, the binding energy is energy which includes cohesive energy and ionization energy. For example, in magnesium, cohesive energy is 1.51 eV/atom, ionization energy is 22.67 eV/atom and binding energy is 24.18 eV/atom.

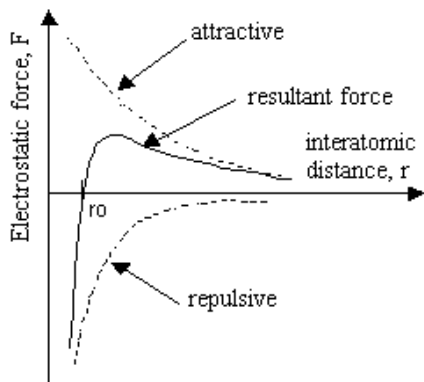

Figure 3.1: Variation of interatomic force to interatomic separation

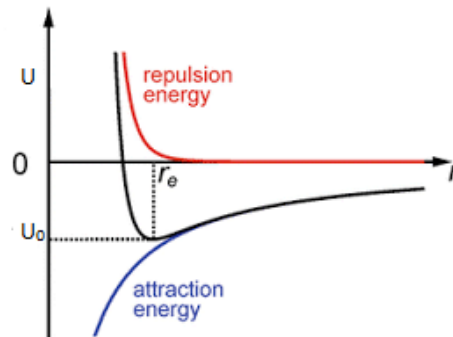

Figure 3.2: Variation of Potential Energy and interatomic separation

3.3.1. Cohesive Energy

The potential energy between two atoms in solid varies greatly with interatomic spacing r and generally given by

$$U(r) = \frac{a}{r^m} + \frac{b}{r^n} \quad (1)$$

Where n and m are integer numbers.

The individual atoms in a solid must be held together by interatomic forces and known as bond. However, there are repulsive forces which provide elasticity to crystal and avoid the atoms to collapse on each other. The attractive forces among the constituent particles are basically electrostatic and depend on the electronic configuration of atoms. Depending on the configuration of atoms, different types of bonding occur as Vander Waal bonding, ionic bonding, coordinate bonding and metallic bonding etc. Based on different types of bonding different kinds of solids come into existence as discussed in next steps.

3.4 INERT GAS SOLIDS AND VANDER WAALS BONDING

The inert gas solids are the simplest crystals. The crystal is transparent, insulators, weakly bond exist at very low temperature. The properties of inert gas solids are given in table 3.1. In the solids of inert gases, the outmost shell of each element (He, Ne, Ar, Kr, Xe) are completely filled and there are no free electrons or vacancies to make ionic or coordinate bond. The ionization energies of inert gas solids are very high thus there is no possibility of transfer or sharing of electrons in these solids. The atoms are neutral in nature. Due to saturation of electronic charge in these solids, there exists a different type of bond called Vander Waals bond and interaction is called Vander Waals- London Interaction.

Table 3.1: Properties of inert gas solids

Inert gas solid	Nearest neighbor distance Å	Cohesive energy		Melting point	Ionization Potential
		kJ/mole	eV/atom		
He					24.58
Ne	3.13	1.88	0.02	24	24.58
Ar	3.76	7.74	0.080	84	15.76
Kr	4.01	11.2	6.116	117	14.00
X	4.35	16.0	0.17	161	12.13

3.4.1. Vander Waals-London interaction

Consider two atoms of an inert gas solid. As we discussed earlier, in case of inert gas solids, the electrons in the outermost shell are completely filled and charge distribution is symmetric and

rigid. There would be no interaction between the atoms because net electrostatic force cancelled to each other. But in actual, the center of electron cloud and positively charge nucleus of each atom, make a weak dipole and two such dipoles interact to each other as shown in figure 3.3.

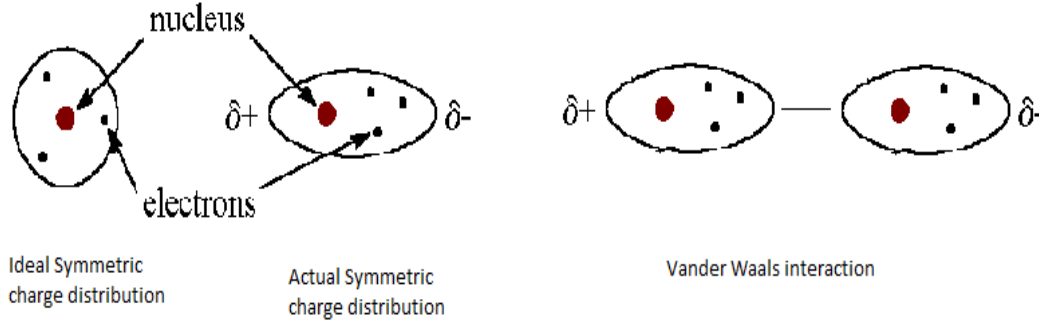

Figure 3.3: Electronic charge distribution of atoms in inert gas solids

Thus in a solid, atoms are arranged in such a way that they induce dipole moments in each other, and induced dipole moments cause an attractive interaction among the atom and formation of inert gas solid takes place.

Consider two atoms of an inert gas solid which are separated by a distance R as shown in figure 3.4. Each atom in the solid behaves as a dipole. We can consider each atom as a linear harmonic oscillator separated by distance R . The electron cloud of each dipole (atom) oscillated with respect to nucleus. Suppose each oscillator has a charge e^- and e^+ separated by distance x_1 and x_2 as shown in figure 3.4. p_1 and p_2 are dipole moment of first and second atoms, and c is force constant of such oscillators. Then the Hamiltonian H_0 of such system when there are no other interactions (unperturbed parts), can be given as

$$H_0 = \frac{1}{2m} p_1^2 + \frac{1}{2} C x_1^2 + \frac{1}{2m} p_2^2 + \frac{1}{2} C x_2^2 \quad (2)$$

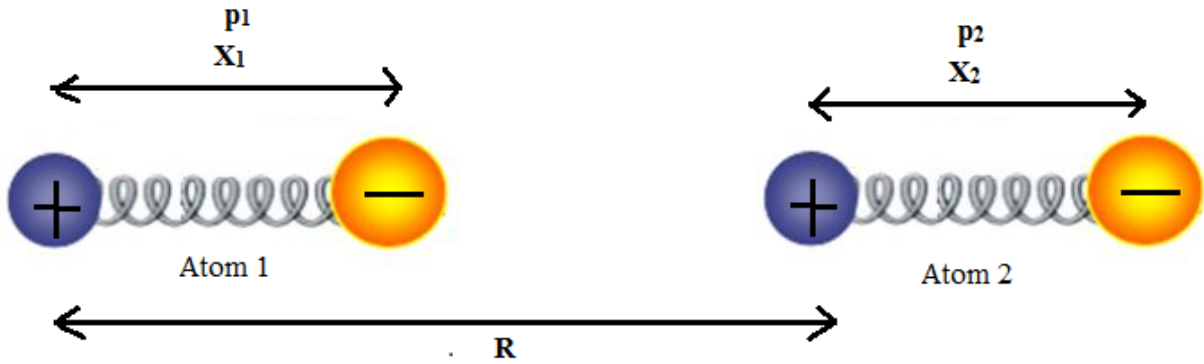

Figure 3.4: Atoms of Inert gas solids as oscillator

Suppose each uncoupled oscillator has frequency ω_0 then $C = m\omega_0^2$

If H_1 is the Coulomb interaction energy of two such oscillators (perturbed part of Hamiltonian) then

$$H_1 = \frac{e^2}{R} + \frac{e^2}{R + x_1 - x_2} - \frac{e^2}{R + x_2} - \frac{e^2}{R - x_1}$$

Since electrons are very close to nuclei in inert gas solids then x_1 or $x_2 \ll R$ thus

$$H_1 = \frac{-2e^2 x_1 x_2}{R^3} \quad (3)$$

Total Hamiltonian is given as

$$H = H_0 + H_1$$

$$H = \frac{1}{2m} p_1^2 + \frac{1}{2} C x_1^2 + \frac{1}{2m} p_2^2 + \frac{1}{2} C x_2^2 - \frac{2e^2 x_1 x_2}{R^3} \quad (4)$$

Now we consider symmetric and anti-symmetric modes positions as x_s and x_a ; and momenta as p_s and p_a which are defined as

$$x_s = \frac{1}{\sqrt{2}} (x_1 + x_2); \quad x_a = \frac{1}{\sqrt{2}} (x_1 - x_2) \quad (5)$$

$$\text{or } x_1 = \frac{1}{\sqrt{2}} (x_s + x_a); \quad x_2 = \frac{1}{\sqrt{2}} (x_s - x_a)$$

Similarly

$$p_s = \frac{1}{\sqrt{2}} (p_1 + p_2); \quad p_a = \frac{1}{\sqrt{2}} (p_1 - p_2) \quad (6)$$

$$\text{or } p_1 = \frac{1}{\sqrt{2}} (p_s + p_a); \quad p_2 = \frac{1}{\sqrt{2}} (p_s - p_a)$$

The details of symmetry and anti-symmetric modes are the part of quantum mechanics. We are using direct formula here.

Now using equation (4) the total Hamiltonian H is

$$H = \frac{1}{2m} \frac{1}{2} (p_s^2 + p_a^2 + 2p_s p_a) + \frac{1}{2} C \frac{1}{2} (x_s^2 + x_a^2 + 2x_s x_a) + \frac{1}{2m} \frac{1}{2} (p_s^2 + p_a^2 - 2p_s p_a) \\ + \frac{1}{2} C \frac{1}{2} (x_s^2 + x_a^2 - 2x_s x_a) - \frac{2e^2 x_1 x_2}{R^3}$$

$$\text{or } H = \frac{1}{2m} (p_s^2 + p_a^2) + \frac{1}{2} C (x_a^2 - x_s^2) - \frac{2e^2}{R^3} (x_a^2 - x_s^2)$$

$$\text{or } H = \left[\frac{1}{2m} p_s^2 + \frac{1}{2} \left(C - \frac{2e^2}{R^3} \right) x_s^2 \right] + \left[\frac{1}{2m} p_a^2 + \frac{1}{2} \left(C + \frac{2e^2}{R^3} \right) x_a^2 \right] \quad (7)$$

Generally Hamiltonian is given as

$$H = \frac{p^2}{2m} + \frac{1}{2} C' x^2$$

In this expression C' is nothing but the force constant and given as $C' = m\omega_0^2$ or $\omega_0 = \sqrt{\frac{C'}{m}}$ which give the frequency. Thus the frequency of oscillation of a system of harmonic oscillator represented by equation (4) can be given as

$$\omega = \sqrt{C \pm \left(\frac{2e^2}{R^3} \right) / m} = \left[C \pm \left(\frac{2e^2}{R^3} \right) / m \right]^{1/2} \quad (8)$$

$$\omega = \omega_0 \left[1 \pm \frac{2e^2}{CR^3} \right]^{1/2} \quad \text{where } \omega_0 = \sqrt{\frac{C}{m}}$$

Using binomial theorem

$$\omega = \omega_0 \left[1 \pm \frac{1}{2} \left(\frac{2e^2}{CR^3} \right) - \frac{1}{8} \left(\frac{2e^2}{CR^3} \right)^2 + \dots \right] \quad (9)$$

The term $\frac{1}{2} \left(\frac{2e^2}{CR^3} \right)$ is corresponding to zero point energy. The change in interaction energy due to coulomb interaction is corresponding to second term. Therefore the change in energy ΔU can be given as

$$\Delta U_a = \frac{1}{2} \hbar (\Delta\omega_s + \Delta\omega_a) = -\hbar\omega_0 \frac{1}{8} \left(\frac{2e^2}{CR^3} \right)$$

$$\Delta U_a = -\frac{A}{R^6} \quad (10)$$

Where A is constant. Thus the attractive interaction varies inversely sixth power of separation between two atoms of inert gas solids.

3.4.2 Repulsive Interaction

A repulsive interaction also exists in the atoms of solids. When two atoms are come together, there charge distributions gradually overlap to each other. The electron cloud of one atom superimposed on other and at a sufficient close separation, repulsive forces gradually come in to existence. The repulsive interaction can also be explained by Pauli's exclusion principle which stated that two electrons cannot have same all quantum numbers. When two atoms come sufficient close there is a tendency of an electron to occupy the quantum state of other electron. The Pauli Principle prevents the electron distribution for multiple occupancy which results repulsive interaction as shown in figure 3.5. There is no theoretical method to evaluate the repulsive force or energy for atoms of inert gas solids but the experimental data show a repulsive potential energy can be given as

$$U_r = \frac{B}{R^{12}} \quad (11)$$

where B is a constant and R is separation.

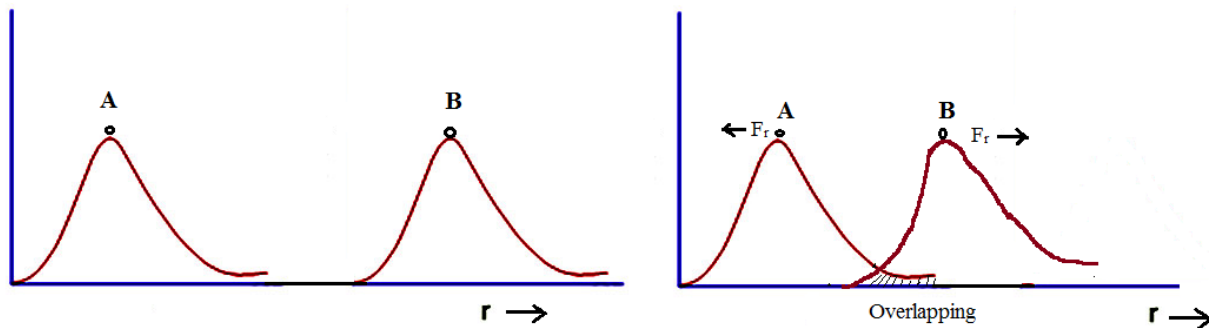

Figure 3.5 : Electron Charge Distribution of two atoms A and B

The total potential energy of two atoms of inert gas solids are given by combining two terms as given by equation (6) and (7)

$$U(r) = U_a + U_r \frac{B}{R^{12}}$$

$$U(r) = \frac{B}{R^{12}} - \frac{A}{R^6}$$

$$U(r) = 4 \epsilon \left[\left(\frac{\sigma}{R} \right)^{12} - \left(\frac{\sigma}{R} \right)^6 \right] \quad (12)$$

Here ϵ and σ are new parameters. The equation (12) is known as Lenard-Zone potential. The force between two atoms can be obtained by differentiating the energy as $-dU/dR$. The values of parameters are given in table 3.2. In this expression we have chosen repulsive potential as B/R^{12} . Other form of empirical relation for repulsive interaction is given as $U = \lambda \exp(-R/\rho)$ which is widely used in solid state physics, where λ and ρ other parameters.

3.4.3. Cohesive Energy

The cohesive energy of an inert gas solid is given by summing up the Lenard Zone potential over all pairs of atoms. If there are N atoms in the solid, then total potential energy is given as

$$U_{total}(R) = \frac{1}{2} N 4 \epsilon \left[\sum_j \left(\frac{\sigma}{p_{ij}R} \right)^{12} - \sum_j \left(\frac{\sigma}{p_{ij}R} \right)^6 \right] \quad (13)$$

Where $p_{ij}R$ is the separation between i^{th} and j^{th} atoms. Since in summation each terms comes twice therefore we introduced a term $\frac{1}{2}$ with N.

$$\text{Experimentally } \sum_j \left(\frac{1}{p_{ij}} \right)^{12} = 12.13 \quad \text{and} \quad \sum_j \left(\frac{1}{p_{ij}} \right)^6 = 14.45$$

Thus above expression reduced as

$$U_{total}(R) = 2N \epsilon \left[12.13 \left(\frac{\sigma}{R} \right)^{12} - 14.45 \left(\frac{\sigma}{R} \right)^6 \right] \quad (14)$$

At $R = R_0$ the above equation reduces as

$$U_{total}(R) = -2.154N \epsilon \quad (15)$$

This is the expression for cohesive energy of all inert gas solids when all the atoms are at rest. There are always some fluctuations which cause correction and called quantum mechanical correction. These fluctuations reduce the cohesive energy of solid but this effect is very small. The effect of quantum correction is an advance field and is an area of research now a day.

3.5 IONIC CRYSTAL AND IONIC BONDING

Ionic bonding is simplest type of bonding which occurs between electropositive and electronegative atoms. The electronegative elements are those have tendency to acquire electron and these elements are on the right side of periodic table (as Cl, F, O, Br etc). The electropositive elements are those elements which can easily give the electron from the outermost shell. Electropositive elements are generally metals and element on the left side of periodic table (as Na, K, Br, I, Mg, Fe, Ni, Cu etc.). When an electronegative atom come into close proximity of an electropositive atom, one or more electron from electropositive atom transfer to electronegative atom and both atoms become ions. There positive and negative ions are bonded by an electrostatic force which is called ionic bonding. The simplest example of ionic bonding is formation of NaCl (sodium chloride) atom.

The electronic configuration of $\text{Na}^{11} = 1s^2, 2s^2, 2p^6, 3s^1$

Thus the Na atom can easily donate electron of its outermost shell to Cl atom. The energy required to remove an electron from outermost shell is called ionization energy. The ionization energy of Na atom is 5.14 eV. Now the electronic configuration chlorine Cl atom is

$\text{Cl} = 1s^2, 2s^2, 2p^6, 3s^2, 3p^5$

Thus the Cl atom can easily acquire an electron as there is vacancy in the outermost shell. When an electronegative atom like Cl gained an electron it releases an energy which is called electron affinity and become Cl^- ion. The electron affinity of Cl atom is 3.16eV. Thus Na gives up it valance electron to Cl and each Na^+ and Cl^- ions are bounded by a strong electrostatic attraction and becomes a stable molecule of NaCl. The reaction can be given as:

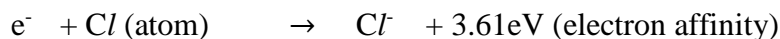

Thus in case of NaCl, a net energy of $5.1 - 3.6 = 1.5\text{eV}$ is to be need in creation of Na^+ and Cl^- ions as



If these two ions come to a close proximity of equilibrium spacing of $r_0 \approx 2.81 \times 10^{-10} \text{ m}$ then the potential energy will be minimum (electrostatic interaction) and the energy released in the formation of NaCl molecule which is called bond energy. The bond energy is given as:

$$V = -\frac{e^2}{4\pi\epsilon_0 r_0} = \frac{(1.6 \times 10^{-19})^2}{4\pi \times 8.85 \times 10^{-12} \times 2.4 \times 10^{-10}} = -6 \text{ eV}$$

This energy will be released in formation of NaCl molecule. Thus the entire process evolve an energy of $6 - 1.5 = 4.5$ eV to produce NaCl molecule from individual Na and Cl atoms.

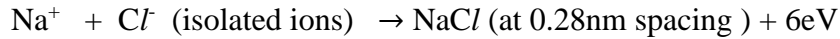

The energy involve in the dissociation of NaCl molecule into Na^+ and Cl^- ions is 6 eV. This value may be comparable to the experimental value of cohesive (lattice energy) of NaCl which is 7.9eV. The value of lattice energy can be calculated more closed with the help of Madelung energy.

3.5.1 Electrostatic or Madelung Energy

The electrostatic interaction between ions is $\pm k \frac{q^2}{r}$ and it is attractive if the ions are oppositely charged, and repulsive if the charges are of same type. The ions in the crystal are arranged them in such a way that the ions give the strongest attractive interaction in the crystal and minimize the repulsive interaction. The repulsive interactions in ionic crystal are same as in inert gas solids. But this interaction is very small with comparison of strong attractive interaction among the ions. The binding energy of ionic crystals arises due to electrostatic interaction is called Madelung energy. Since a crystal contains a very large number of ions therefore the interaction energy between i^{th} ion and j^{th} can be given as U_{ij} . If we define interaction of i^{th} ion to all other remaining ions as U_i then U_i can be given as the sum of all interactions of i^{th} ion with all remaining ions say then

$$U_i = \sum_j U_{ij} \quad \text{where } j = 1, 2, \dots, n \text{ except } j = i \quad (16)$$

The interaction U_{ij} has two components a repulsive potential in the form of $\lambda \exp(-r/\rho)$ where λ and ρ are constants. The another interaction is Coulomb potential energy $V = \pm \frac{1}{4\pi\epsilon_0} \frac{q^2}{r_0}$ thus

$$U_{ij} = \lambda \exp(-r_{ij}/\rho) \pm \frac{1}{4\pi\epsilon_0} \frac{q^2}{r_{ij}} \quad (17)$$

$$U_{ij} = \lambda \exp(-r_{ij}/\rho) \pm \frac{q^2}{r_{ij}} \quad (\text{in CGS system}) \quad (18)$$

The repulsive term is same as in inert gas solids and can be taken as $\frac{\sigma}{R^{12}}$ but the form $\lambda \exp(-r_{ij}/\rho)$ gives better representation in ionic solids where ρ range of repulsive interaction.

In ionic solids like NaCl, if we ignore the surface effect them term U_i does not depend on reference ion, we can consider any ion as reference. Thus if a crystal contains N molecules of NaCl or 2N ions, then total lattice energy (interaction energy) can be given as

$$U_T = NU_i \quad (19)$$

We count each pair of ions only once. Thus we use N in place of $2N$, total number of ions. The total lattice is the energy required to break the crystal into individual ions at sufficient far (infinite) distance apart. With the help of total lattice energy, we can calculate lattice energy per molecule.

For convenience we introduce a term p_{ij} such that separation between two i^{th} and j^{th} ion can be given as :

$$r_{ij} = p_{ij}R \quad (20)$$

Where R is nearest neighbor separation between two ions in a crystal or called as equilibrium separation. Now equation (18) becomes

$$U_{ij} = \lambda \exp(-R/\rho) \pm \frac{1}{p_{ij}} \frac{q^2}{R} \quad (21)$$

Thus the total lattice energy can be given as

$$U_T = N \sum_j U_{ij} = N \left(\lambda \exp(-R/\rho) \pm \sum_j \frac{1}{p_{ij}} \frac{q^2}{R} \right)$$

$$U_T = N \left(z \lambda \exp(-R/\rho) \pm \alpha \frac{q^2}{R} \right) \quad (22)$$

Where $\alpha \equiv \sum_j \frac{\pm 1}{p_{ij}} = \text{Madelung constant}$ (23)

Where z is another parameter which represents the number of nearest neighbors. The value of α is important for the theoretical calculation of binding energy of ionic crystals.

At equilibrium separation, the energy becomes minimum therefore

$$\frac{dU_T}{dR_0} = 0$$

Thus eq. (18) becomes

$$\frac{dU_T}{dR} = N \frac{dU_i}{dR_0} = -\frac{Nz\lambda}{\rho} \exp\left(-\frac{R}{\rho}\right) + \frac{N\alpha q^2}{R_0^2} = 0 \quad (24)$$

$$\text{or } \frac{Nz\lambda}{\rho} \exp\left(-\frac{R}{\rho}\right) = \frac{N\alpha q^2}{R_0^2}$$

$$\text{or } \frac{Nz\lambda}{\rho} \exp\left(-\frac{R_0}{\rho}\right) = \frac{N\alpha q^2}{R_0^2}$$

$$\text{or } R_0^2 \exp\left(-\frac{R_0}{\rho}\right) = \frac{\rho\alpha q^2}{z\lambda} \quad (25)$$

This equation determines the equilibrium separation R_0 .

Total lattice energy can be obtained by putting the value of R_0 from eq. (25) into equation (18) then

$$U_T = N \left(\frac{\rho\alpha q^2}{R_0^2} - \alpha \frac{q^2}{R_0} \right)$$

$$U_T = \frac{N\alpha q^2}{R_0} \left(1 - \frac{\rho}{R_0} \right) \quad (26)$$

The term $\frac{N\alpha q^2}{R_0}$ is called madelung energy. Since the value of ρ is very small $\rho \approx 0.1R$ thus the total repulsive energy is very small, and net energy is negative which is attractive in nature, and crystal bonded strongly.

Calculation for Madelung Constant α

The Madelung constant α was first calculated by Madelung. By definition of α

$$\alpha = \sum_j \frac{\pm 1}{p_{ij}}$$

Where p_{ij} represents all combination of ion in a crystal. As we defined $r_{ij} = p_{ij}R$ thus

$$\frac{\alpha}{R} = \sum_j \frac{\pm 1}{r_{ij}} \quad (27)$$

Where r_{ij} is distance between i^{th} and j^{th} ions.

Now consider an infinite long chain of ions in which positive and negative ions are linearly arranged in a repetitions of R as shown in figure 3.6.

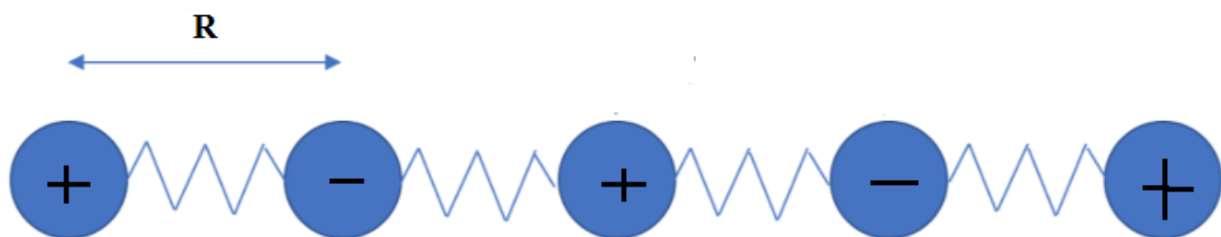

Figure 3.6: Linear Chain of ions in a crystal

From eq. (27) $\frac{\alpha}{R}$ can be given as

$$\frac{\alpha}{R} = 2 \left[\frac{1}{R} - \frac{1}{2R} + \frac{1}{3R} - \frac{1}{4R} \dots \dots \dots \right]$$

$$\alpha = 2 \left(1 - \frac{1}{2} + \frac{1}{3} - \frac{1}{4} \dots \dots \dots \right) = 2 \ln 2$$

The factor 2 arises since there are two ions, one is to right side and another to left side at same distance. Thus the value of Madelung constant for one dimensional chain of ions in a crystal is $2 \ln 2$. In three dimension, it is very difficult to consider all chains and not possible to find out simple expression.

Typical value of Madelung constant of some ionic crystals are given below

Crystal	NaCl	CsCl	ZnS
Madelung constant	1.74	1.76	1.63

3.6 COVALENT CRYSTALS

If two atoms have opposite types of number of electrons in outmost shell (for example 1 and 7 electrons in outermost shell), then they have heterogeneous nature of charge and they make generally heteropolar bond or ionic bond. But if the atoms have same type number of electrons in outermost shell they have homogenous nature of charge, they have tendency to make a different kind of bond known as homopolar or covalent bond. Covalent type bond occurs basically by sharing of electrons, between different types of non metal- non metal atom like CH_4 , and metalloid-non metal atom like SiO_2 etc. The bond between carbon atoms in diamond is a strong covalent bond with bond strength comparable to ionic bond.

The Covalent bond has strong directional properties. For example, the carbon in diamond has four nearest neighbor atoms arranged in tetrahedral angles as shown in figure 3.7. The structure of diamond has been discussed in previous first unit. The directions of atoms are fixed for the

existence of diamond structure. The tetrahedral structure allows only four nearest atoms with packing fraction 0.34. The same bonding is shown by boron, silicon, germanium etc.

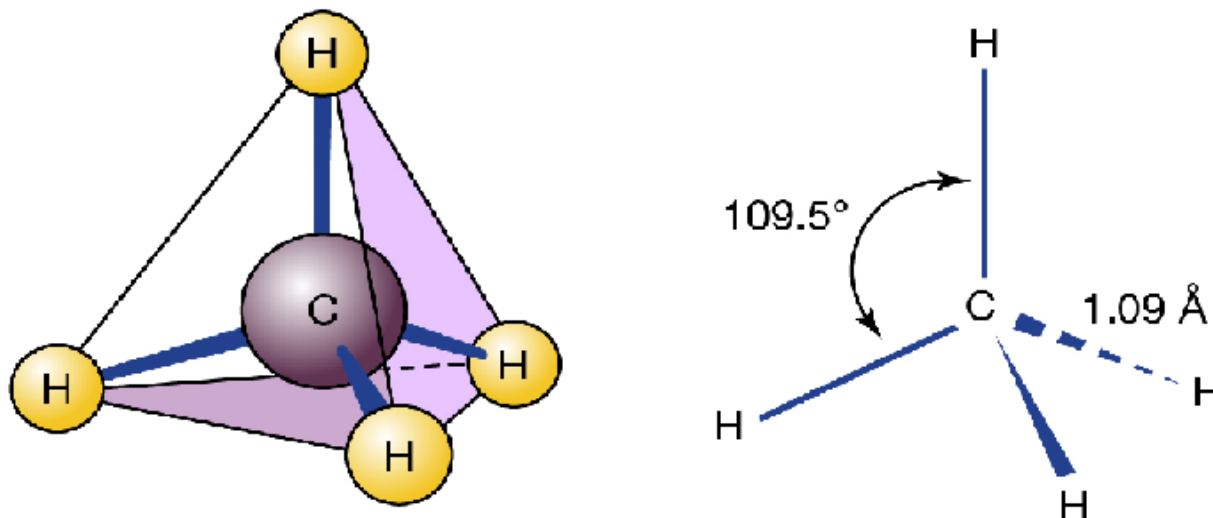

Figure 3.7: Tetrahedral shape of CH_4 , Diamond molecule

The simplest example of covalent bond is formation of hydrogen molecule, in which each electron of both atoms, is arranged in such a way that the pair of electron is shared by both atoms. Figure 3.8 shows the sharing of electrons by both atoms.



Figure 3.8: Covalent bonding in Hydrogen molecule

After sharing of electron both atoms complete their outmost electron orbit, and this tendency of completion of outermost electron orbit becomes a bonding known as covalent bonding. In formation of hydrogen molecule, the two electrons are in between the nuclei of both atoms and two electrons are more like to be found at the between the nuclei therefore the electron density is maximum in this region.

The covalent bond comes into existence when the separation between atoms is 0.074nm, equilibrium distance where repulsive and attractive forces of both atoms balance each other. The bond energy of covalent bond in hydrogen molecule is about 4.5eV which is required to break a covalent bond in H₂ molecule.

Thus



The covalent bond is represented by H-H. Sometime the other representation is also used as H:H which indicates the sharing of electrons from different atoms. The large number of organic materials in biology and in organic chemistry covalent bonding is occurred. Some examples of covalent bonds are listed below. Similarly many semiconductors also show covalent bonding.

Table 2: Covalent Bond and their bond length and bonding energy

Bond	Bond length nm	Bond energy kJ/mole	Bond	Bond length nm	Bond energy kJ/mole
<i>H – H</i>	0.074	736	<i>N – N</i>	0.100	390
<i>C – H</i>	0.108	414	<i>N ≡ N</i>	0.109	945
<i>C – C</i>	0.154	348	<i>Cl – Cl</i>	0.199	242
<i>C = C</i>	0.134	615	<i>H – Cl</i>	0.128	431
<i>C ≡ C</i>	0.122	840	<i>C – Si</i>	0.193	301
<i>C – O</i>	0.143	358	<i>Si – H</i>	0.145	293
<i>C = O</i>	0.122	748	<i>Si – Si</i>	0.234	176
<i>O – H</i>	0.097	463	<i>Si – Cl</i>	0.216	360
<i>O = O</i>	0.121	498	<i>Si – O</i>	0.183	368

The electrons in atoms are arranged in different shells designed by principle quantum numbers (n= 1,2,3,...) and further the electrons of each shell are arranged in different orbitals (s,p,d,f corresponding to l= 0,1,2,3,...). Each orbital can occupy maximum number of electrons as s², p⁶, d¹⁰, f¹⁴ (2,

6, 10, 14 respectively). When a covalent bond is formed, the orbitals become fully filled depending on the number of bond. For example in hydrogen molecule, when the pair of electron is shared by atoms, the s orbital is completely filled and hydrogen molecule becomes stable. There is no further possibility of third hydrogen atom or electron for making bond. Thus the covalent bond exhibits saturation. Further the covalent bond is directional in nature. Since covalent bond is formed after the overlapping of different orbitals thus bond would be lie along the direction of overlapping.

3.7 METALS AND METALLIC BOND

Metallic bonds are the forces of attraction between free floating electron, valance electron and positively charged cation. Metallic bonds are found in metals and alloys. In metal, all electrons belong to the metal are considered a whole rather than any particular atom. Metals have low ionization energies and atoms of such elements give their valance electrons to form as whole electron sea or say ‘electron gas’ throughout the space. Having giving up their valance electron, the atoms become positive ions called core which float in the electron sea as shown in figure 3.9. These positive ions are held together by electrostatic force in the electron sea. These bonds are called metallic bonds. The high electric and thermal conductivity of metallic solid are result of ability of free movement of electron through Electron Sea in the crystal.

Unlike other crystal, metals show high melting point, good conductor, hard, dense, high tensile, strength, malleable, ductile, Luster. The most of such properties are because of electron sea permits atoms to slide inside crystal structure by acting as lubricant. This property cannot be seen in covalent bonds as the movement atoms break the bond. Copper, solidus, silver, gold, iron, aluminum are examples of metallic crystals.

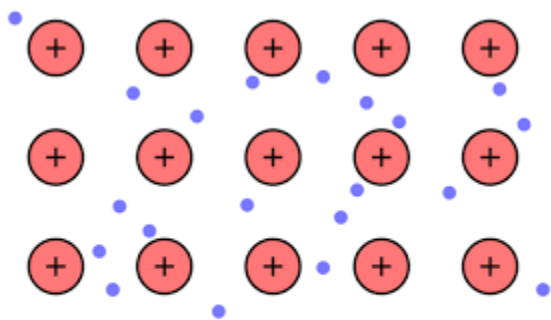

Figure 3.9: Electron sea in metallic bonding

3.8 INTERMOLECULAR BOND

We have discussed ionic, covalent and metallic bonds. These all bonds are result from transfer or sharing of electron. These bonds are classified as primary bond. These bonds are strong and

involve electrons and generally responsible for the formation of molecules. The bonds that hold molecules together to form a solid is called secondary bond. The secondary bonds are considerably weak, intermolecular, and arise due to induced attractive dipole interaction when molecules come to close proximity. The secondary bonds are Vander Waals bond, hydrogen bond etc. We have already discussed Vander Waals bond now we discuss about hydrogen bond.

3.9 HYDROGEN BOND

Hydrogen bond is a special type of bond formed between hydrogen and an extremely electronegative atom like (O, F, N). In this case when hydrogen atom is covalently bonded with high electronegative atom, the electron cloud is strongly attracted by electronegative atom and a permanent electric dipole is set up as hydrogen polarized with negative charge. These dipoles of molecules are arranged themselves in such a way that all molecules attract each other and form solid crystal or liquid. The examples of hydrogen bonds are H_2O , water molecules, ferroelectric solids like KH_2PO_4 , proteins, DNA etc. In water hydrogen and oxygen atom formed covalent bond as shown in figure 3.10.

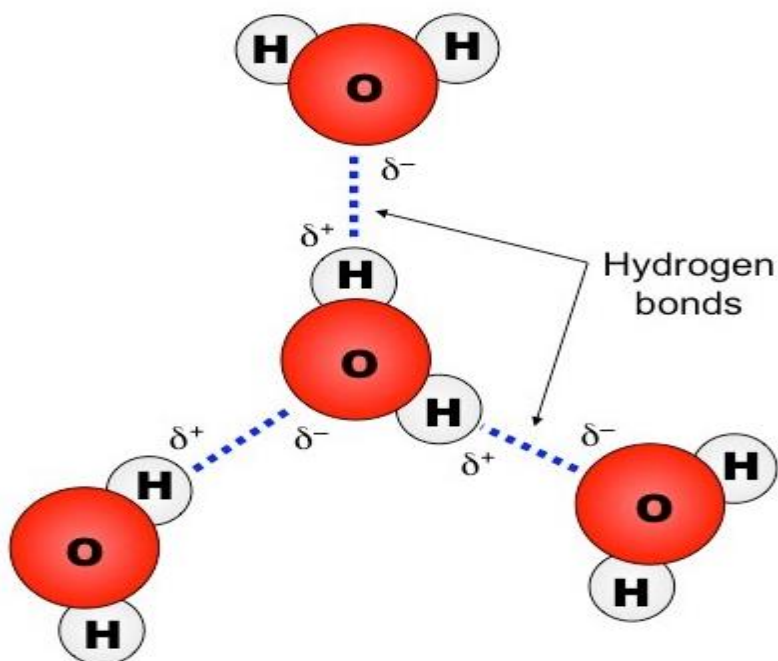

Figure 3.10: Hydrogen bonds in water molecules

In figure 3.10, H_2O molecule is formed with the help of covalent bond. After bonding, the oxygen, a strong electronegative atom attracts electron cloud and polarized with a charge δ^- and hydrogen atom polarized with charge δ^+ . The O-H bond between oxygen atom of one molecule of H_2O

and hydrogen atom of another molecule is formed and this electrostatic bond called hydrogen atom. Hydrogen bond is responsible for cohesion of water which further responsible for surface tension. Thus the water form droplets and these properties are important for many biological process and basis for the life.

Self Assessment Questions (SAQ)

1. What is the main force responsible for the formation of crystalline solids?
2. What are primary and secondary bonds?
3. Explain cohesive and binding energy of a solid.
4. Distinguish cohesive, ionization and binding energy.
5. What is lattice energy?
6. Calculate the cohesive energy of NaCl crystal.
7. What is force which holds the atoms of inert gas solid?
8. Give the origin of repulsive force in inert gas solids.
9. What is harmonic oscillator? Why, we consider the atoms on inert gas solids as harmonic oscillator?
10. Why we cannot obtain the Madelung constant for a chain of ions in three dimensions?
11. Explain metallic bonds.
12. Why the metallic solids are good conductors of electricity and heat?
13. Why hydrogen bonds are significant in nature?

3.10 SUMMARY

1. In this unit, we have learnt about crystal bonding and known how different types of crystals are formed due to different types of bonding.
2. According to their bonding, crystals have been divided into different groups- ionic crystals, covalent crystal or homopolar crystals, metallic crystals, Vander Waals or molecular crystals and hydrogen bonded crystals.
3. Cohesive energy which is defined as the energy of an ionic crystal that would be liberated by the formation of the crystal from individual neutral atoms. The main contribution to the cohesive energy of an ionic crystal is the electrostatic potential energy U of the ions.
4. The atoms of inert gas solids (He,Ne,Kr) are neutral in nature. Due to saturation of electronic charge in these solids, there exists a different type of bond called Vander Waals bond and interaction is called Vander Waals- London Interaction.

$$\text{Lenard - Zone potential } U(r) = 4 \epsilon \left[\left(\frac{\sigma}{R} \right)^{12} - \left(\frac{\sigma}{R} \right)^6 \right]$$

5. When an electronegative atom come into close proximity of an electropositive atom, one or more electron from electropositive atom transfer to electronegative atom and both atoms become

ions. There positive and negative ions are bonded by an electrostatic force which is called ionic bonding.

6. *Madelung constant which is a property of ionic crystal structure is given as*

$$\alpha \equiv \sum_j \frac{\pm 1}{r_{ij}} = \text{Madelung constant}$$

7. the atoms have same type number of electrons in outermost shell they have homogenous nature of charge, they have tendency to make a different kind of bond known as homopolar or covalent bond. The Covalent bond has strong directional properties.

8. Metallic bonds are the forces of attraction between free floating electron, valance electron and positively charged cation. Metallic bonds are found in metals and alloys.

9. Hydrogen bond is a special type of bond formed between hydrogen and an extremely electronegative atom like (O, F, N). In this case, hydrogen atom is covalently bonded with high electronegative atom, the electron cloud is strongly attracted by electronegative atom and a permanent electric dipole is set up which is responsible for cohesion of molecules.

3.11 GLOSSARY

Bonding: Attraction between atom, molecules or ions in a material

Cohesion: To stick together or stay together.

Inert gases: Gas do not undergo chemical reaction

Vander Waals Force: Weak, short range electrostatic force between molecule or atoms

Hamiltonian: In quantum mechanics, a Hamiltonian is an operator, which represent sum of kinetic and potential energy

Harmonic Oscillator: A system which oscillates regularly under certain restoring force

Metal: Material with high conductivity lustrous, malleable and ductile.

3.12 REFERENCES

- 1.C Kittel, Introduction to Solid State Physics 7th Edition, John Wiley and Sons, Singapore
2. H C Gupta, Solid State Physics, Vikas Publication House, New Delhi
3. <https://www.researchgate.net/publication>
4. <https://byjus.com/chemistry/bcc-fcc-primitive-cubic-unit-cell>
5. Introduction to Solid State Physics, Arun Kumar, PHI Learning Private Limited, New Delhi

3.13 SUGGESTED READIN

1. O S Pillai, Solid State *Physics*, New Age International(P) limited, New Delhi
2. L Poling, Nature of chemical bond, Cornell
Solid State Devices, B.Somanathan Nair, S.R. Deepa, PHI Learning Private Limited, New Delhi.
3. Fundamentals of Solid State Physics, B.S. Saxena, R.C. Gupta, P.N. Saxena, Pragati Prakashan Meerut.

3.14.1 Short Answer Type Questions

1. Explain the bonding of atoms in crystalline solids.
2. Explain the bonding energy in terms of interatomic separation.
3. What do you mean by Vander Waals interaction?
4. Explain the formation of inert gas solids.
5. Give the origin of attractive and repulsive interactions in the inert gas solids.
6. Explain the origin of ionic bonding.
7. What do you mean by lattice energy and cohesive energy?
8. Calculate the Madelung constant for one dimensional chain of ions.
9. What are metallic bonds?
10. Explain the origin of covalent bond.
11. What is the difference between covalent and metallic bond.
12. What are primary bonds and secondary bonds? Give the difference.
13. What is hydrogen bond? Give an example of solid which show hydrogen bond.

3.14.2 Long Answer Type Questions

1. What is Vander Waals interaction? Obtain the expression for Lennard Jones Potential.
2. Explain the formation of ionic crystals. Find out expression for Madelung constant for the linear chain of ions.
3. Obtain an expression for the cohesive energy, bulk modulus and coefficient of thermal expansion of a linear molecular solid consisting N atoms.
4. Find out an expression of cohesive energy and bulk modulus of an ionic solid by considering that the repulsive energy of ions is given by $\frac{B}{r^n}$.
5. With the help of Lennard-Jones Potential, calculate the ration of cohesive energy of neon in bcc and fcc structure.(Ans. 0.956) The lattice sum for the bcc structure are:

$$\sum_j p_{ij}^{-12} = 9.1141 ; \quad \sum_j p_{ij}^{-6} = 12.2533$$

6. Consider a line of $2N$ ions in an ionic solid and each ion has charge $\pm q$ with repulsive potential $\frac{A}{R^n}$ between two nearest neighbors. Show that at equilibrium separation

$$U(R_0) = -\frac{2Nq^2 \ln 2}{R_0} \left(1 - \frac{1}{n}\right)$$

UNIT 4**CRYSTAL DEFECTS**

Structure

- 4.1 Introduction
- 4.2 Objective
- 4.3 Classification of crystal line defects
- 4.4 Point Defects
 - 4.4.1 Vacancies
 - 4.4.2 Self-Interstitial
 - 4.4.3 Impurity
 - 4.4.4 Schottky Defects in metallic crystals
 - 4.4.5 Frankel Defects in metallic crystals
 - 4.4.6 Diffusion
 - 4.4.7 Color centers
 - 4.4.8 F centers
- 4.5 Line Defects
 - 4.5.1 Edge dislocation
 - 4.5.2 Screw dislocation
 - 4.5.3 Mixed dislocation
 - 4.5.4 Observation of dislocation
- 4.6 Surface defects and grain boundaries
- 4.7 Volume Defects
- 4.8 Summary
- 4.9 Glossary
- 4.10 References
- 4.11 Suggested reading
- 4.12 Terminal questions

4.1 INTRODUCTION

A crystal is defined as combination of lattice and basis. In a perfect crystal there is a long range periodic arrangement of lattice point at lattice sites. However, in reality the crystals show some deviation from perfect ordering of atoms or molecules from their actual ordered lattice positions. All deviations from the specified ordered periodicity are called defects or imperfections. If a crystal does not possess defects, then it is called ideal crystal. In general, all crystals are not ideal and always show some considerable defects. The defect or imperfection affects the physical properties, chemical properties, mechanical or electrical properties of a material. Thus the study and analysis of defects exist in a solid or material is important in various technological processing and applications.

Knowing the Imperfection in a crystal we can obtain the required behavior of solid. For example, (70% Cu + 30% Zn) is much harder and stronger than pure copper. Thus the lattice irregularities in crystal result tremendous effect on properties of material. It should be noted that the Imperfections or defects in crystal affect the crystal structure but they bring some specific useful characteristics in the material. For example, the electrical resistance in an electric wire (heater element) can be controlled by adding some impurity in the material. Therefore, the study of imperfect crystals is equally significant as perfect crystal.

4.2 OBJECTIVE

After reading this unit we will able to understand:

- different type of defects and imperfection in crystal
- point Defects
- line defects
- surface defects
- volume defects

4.3 CLASSIFICATION of DEFECTS

On the basis of dimensions, the defects are classified in four groups as given below.

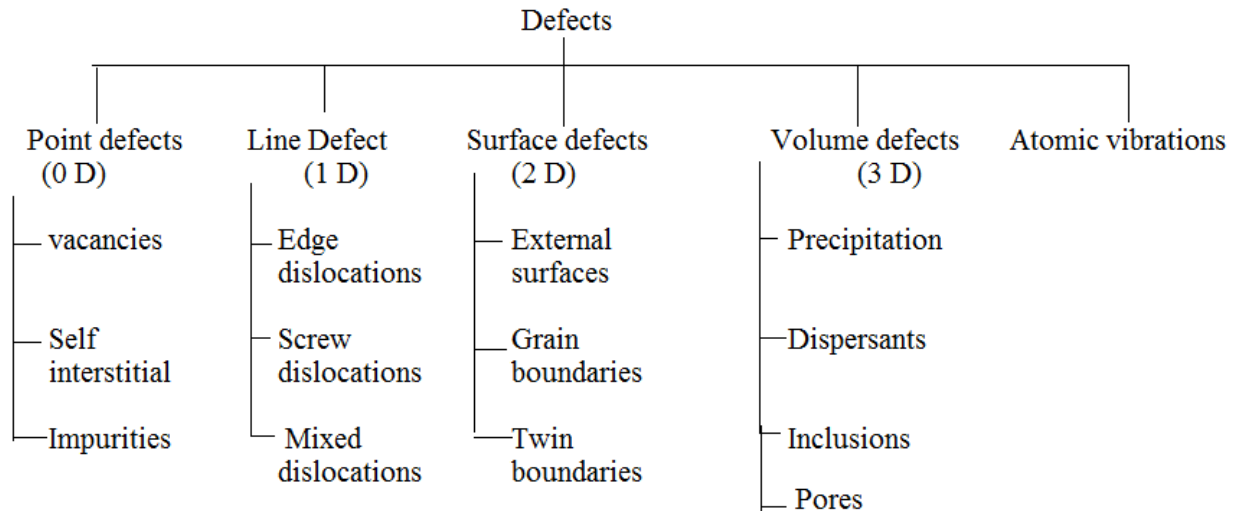

4.4 POINT DEFECTS

Point defects are simplest imperfection in crystal. In such type of defects an atom involves individually and therefore called zero dimension (0D) defect. Point defect is very localised and not spread over more than one or two lattice spacing. Point defect does not affect the perfection of more distant parts of crystal. The point defect is generally three types as vacancies, interstitial and impurity.

4.4.1 Vacancies

Vacancies are those sites which are unoccupied in the crystal structure. At vacancies, atoms are absent from its regular atomic positions. All crystalline solids contain vacancies. These vacancies are also known as Schottky defect. If an atom of crystal leaves its site, create a vacancy and fit interstitial, is known as Frenkel defect. The Schottky and Frenkel defects are shown in figure 4.1(a). Presence of vacancies increases the entropy (randomness) of crystal. At equilibrium the number of vacancies can be given as

$$N_v = N \exp\left(-\frac{Q_v}{kT}\right) \quad (1)$$

where N_v = number of vacancies,

N = total number of atoms

Q_v = Energy required to form a vaccine

k = Boltzman constant and T is temperature

For metal $N_v \approx 10^{-4}$

4.4.2 Interstitials

Interstitials are atoms which occupy a site in the crystal structure at which there is usually not any atom. We can say an interstitial atom can be inserted into the voids between regularly occupied sites as shown in figure 4.1(b). Atoms can move from its original site to an interstitial site and create a vacancy in original positions.

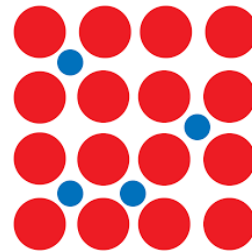
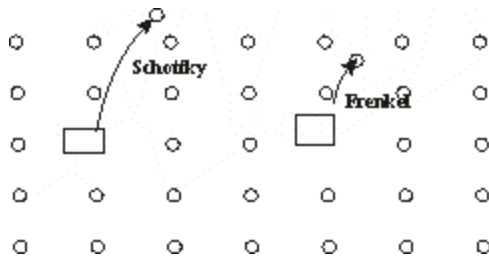
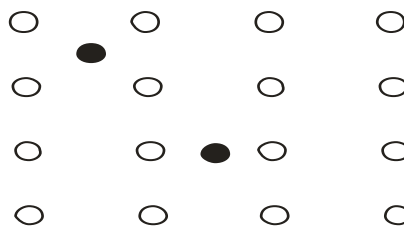
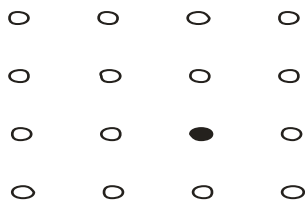

Figure 4.1(a) Vacancies in a crystal

Figure 4.1(b) Interstitials in a crystal

4.4.3 Impurity

If an impurity atom is present in a perfect crystal, it also causes a point defect. The impurity atom may fit into the crystal structure in two ways. (i) The impurity atom may occupy a position normally occupied by crystal atom (host atom). This case is called substitutional impurity. (ii) In second case, the impurity atom occupies the unfilled space (volume) of crystal. The unfilled space is called interstitial and hence impurity atoms are called interstitial impurity.



Figures 4.2 Substitutional impurity **Figure 4.3** Interstitial impurity

The impurity is used in metallic crystal structure to enhance the strength of metal and achieve corrosion resistance. In this process, a solid solution is formed by adding solute (impurity) atom

in the main metal solution. The crystal structure is maintained and no new structure is formed during the process of adding impurity.

In metallic crystals, following are the factors which determine the degree of dissolving of solute (impurity).

- (i) Atomic size factor: Atomic radius is to be less than 15%
- (ii) Crystal structure: Same for both solvent and solute
- (iii) Electronegativity: One Electronegativity + Another Electropositive = intermetallic compound
- (iv) Valances: Metals have more tendency to dissolve another metal of higher valancy.

Specification of computation:

Composition or concentration is determined by following methods. This is basically relative content of a specific element.

- (i) Weight or mass percent: For two element alloy it can be given as

$$C_1 = \frac{m_1}{m_1 + m_2} \times 100 \quad (2)$$

Where m_1, m_2 are masses in gm.

- (ii) Atomic percent: Atomic percentage of an element can be given as

$$C_1 = \frac{n_{m1}}{n_{m1} + n_{m2}} \times 100 \quad (3)$$

Where n_{m1}, n_{m2} are number of atoms.

4.4.4 Schottky Defects in Metallic Crystal

Schottky defects are basically missing of atoms from the lattice sites of crystal. The vacancies exist at all temperature as defects created during the crystal formation. The concentration of defects in crystal depends on the energy of formation of the crystal. Thermodynamically the free energy should be minimum at a particular temperature during the crystal formation.

Let us consider a crystal consists of N total number of atom at a temperature T . The free energy of crystal is $F(T)$ and suppose there are n vacancies created by transferring atoms from their regular sites to surface. Let the energy of formation of vacancies is E_v which is energy required to remove an atom from its regular site to surface of crystal. To removal of n atoms from their regular site to surface of crystal is nE_v . If U is energy associated and S is entropy associated with crystal then for a perfect crystal:

$$F = U - TS \quad (4)$$

If S_{CF} is configurational entropy and S_{Th} thermal entropy then

$$F = U - T (S_{Th} + S_{CF}) \quad (5)$$

Since for perfect crystal $S_{CF} = 0$ then

$$F = U - TS_{Th} \quad (6)$$

Similarly, the free energy of an actual crystal containing n vacancies can be given as

$$F_a (n, T) = U + nE_v - T (S_{Th} + n\Delta S_{th}) - kT \log W \quad (7)$$

Where ΔS_{Th} is change in thermal entropy during vacancy creation and W is number of ways, in which the atoms may be arranged over the available lattice sites.

$$F_a (n, T) = U - TS_{Th} + nE_v - nT\Delta S_{Th} - kT \log \left[\frac{N!}{(N-n)! n!} \right] \quad (8)$$

$$\text{Since Thermodynamically } W = \left[\frac{N!}{(N-n)! n!} \right]$$

Now eq. (8) can be written as

$$F_a (n, T) = F + nE_v - nT\Delta S_{Th} - kT \log \left[\frac{N!}{(N-n)! n!} \right] \quad (9)$$

Using sterling formula $\log x! = x \log x$ for $x \gg 1$

Thus above eq. (9) can be written as

$$F_a (n, T) = F + nE_v - nT\Delta S_{Th} - kT [N \log N - (N-n) \log (N-n) - n \log n] \quad (10)$$

$$\text{In equilibrium } \left(\frac{\partial F_a}{\partial n} \right)_T = 0$$

Then eq. (10) can be given as

$$E_v - T\Delta S_{Th} - kT [\log (N-n) - \log n] = 0$$

$$\text{or } \log \frac{n}{N-n} = \frac{-E_v + T\Delta S_{Th}}{kT}$$

$$\text{or } \frac{n}{N-n} = e^{\Delta S_{Th}/k} \cdot e^{-E_v/kT}$$

If $n \ll N$ then

$$\frac{n}{N} = A \cdot e^{-E_v/kT} \quad (11)$$

where A is a constant as $e^{\Delta S_{Th}/k}$ called some time exponential factor and considered as unit.

$$\text{Or } \frac{n}{N} = e^{-E_v/kT} \quad (12)$$

If $E_v = 1$ eV, temperature = 1000K then $\frac{n}{N} \approx 10^{-5}$. The equilibrium concentration of vacancies decreases as temperature decreases.

Using similar statistical calculation, the equilibrium concentration for ionic crystal can be calculated and the expression is given as

$$\frac{n}{N} = e^{-E_v/2 kT} \quad (13)$$

4.4.5 Frenkel Defects in Metallic Crystals

A Frenkel defect is basically vacancy created by moving an atom from its actual regular position to interstitial positions. The calculation of Frankel defect is similar type procedure as for Schottky defects calculation.

Let us consider a metallic crystal at temperature T contains at N atoms, N_i is interstitial sites, n is number of Frenkel defects (n vacancies or n interstitial atoms are shifted in its interior), E_f is energy required to create a Frenkel vacancy. Then the expression for free energy for an actual crystal containing n Frenkel defects at temperature T can be given as (as in eq. 4)

$$F_a(n, T) = U - TS_{Th} + nE_f - nT\Delta S_{Th} - kT \log \left[\frac{N!}{(N-n)! n!} + \frac{N_i!}{(N_i-n)! n!} \right] \quad (14)$$

$$F_a(n, T) = U - TS_{Th} + nE_f - nT\Delta S_{Th} - kT \log w$$

$$\text{where } w = \left[\frac{N!}{(N-n)! n!} + \frac{N_i!}{(N_i-n)! n!} \right] \quad (15)$$

w is number of way by which atoms may arranged in available interstitial sites, and can be calculated by statistical mechanics. By using Sterling formula, Eq. 14 can be written as

$$F_a(n, T) = F + nE_f - nT\Delta S_{Th} - kT [N \log N - (N-n) \log (N-n) - n \log n + N_i \log N_i - (N_i-n) \log (N_i-n) - n \log n] \quad (16)$$

$$\text{At equilibrium } \left(\frac{\partial F_a}{\partial n} \right)_T = 0 \quad (17)$$

Thus differentiating equation (16)

$$\left(\frac{\partial F_a}{\partial n} \right)_T = E_f - T\Delta S_{Th} - kT [\log (N-n) (N_i-n) - \log n^2] = 0$$

$$\text{Or } \frac{T\Delta S_{Th} - E_f}{kT} = \log n^2 - \log (N-n) (N_i-n)$$

$$\text{Or } \frac{n^2}{(N-n) (N_i-n)} = e^{\Delta S_{Th}/kT} \cdot e^{-E_f/kT}$$

If $n \ll N$ and $n \ll N_i$ then

$$\frac{n^2}{N \cdot N_i} = A \cdot e^{-E_f/kT}$$

$$\text{or } n = \sqrt{N N_i} \cdot A e^{-E_f/2kT} \quad (18)$$

$$\text{or } n = \sqrt{N N_i} \cdot e^{-E_f/2kT} \quad (19)$$

Considering constant A i.e. exponential factor as unit 1. This is expression for number of Frenkel defects in a metallic crystal. Similarly, we can calculate number of Frankel defects for ionic crystals and by using statistical calculation.

4.4.6 Diffusion

In solid if there is a variation in concentration or concentration gradient of impurities or vacancies, and then there will be a flux through the solid. However, in equilibrium, there is no flux, and impurity or vacancies are distributed uniformly.

The flux J_N of impurities or vacancies in a crystal is given by Fick's law given as

$$J_N = -D \text{ grad } N = -D \cdot \frac{dN}{dx} \quad (20)$$

Where N is concentration of impurities or vacancies, $\frac{dn}{dx}$ is concentration gradient and D is diffusion constant or diffusivity (unit m^2/s). The negative sign indicates that diffusion takes place from higher concentration to lower concentration side.

The diffusion constant is often given as

$$D = D_0 \exp(-E/kT) \quad (21)$$

Where E is an activation energy, k is Boltzmann constant and T is temperature, D_0 is constant and give as $D_0 = v a^2$ where v is a characteristic atomic vibrational frequency and a is lattice constant. Then D can be given as

$$D = v a^2 \cdot \exp(-E/kT) \quad (22)$$

4.4.7 Color Centers

Pure alkali halides or ionic crystals have band gap of order $\approx 6 \text{ eV}$ which is corresponding to 2000 \AA wavelength. This wavelength is in the region of ultra violet, not in optical or visible region (3500 \AA to 7800 \AA). Thus the pure alkali Halides crystal (NaCl , KBr , LiF , KCl etc) are transparent throughout the visible region. But these crystals can be made able to observe visible light or crystal may be coloured under certain conditions. In fact, in the presence of certain lattice defects (vacancies or impurities) these crystal show colours which are called colour centers.

The crystal shows color centers by following ways

1. By adding chemical impurities:

By adding the chemical impurities like transition metals (Ti , V , Cu , Zn etc.) the colour centers can be produced. The colors are corresponding to energy band gap of impurity atoms.

2. By introducing an excess of metal ions:

We can heat the crystal in vapor of alkali metal and cool down it. For example KCl crystal is heated in presence of K (potassium) vapour and cool down it. The crystal formed contains excess K ions which give the particular color centers under the visible light.

3. Bombardments of high energy radiation (x ray, γ ray, neutron beam):

When a sample of alkali halide is exposed to high energy radiation the atom of crystal components is ionized. In this process the electron and holes are released and trapped in the vacancies. These filled vacancies produce color centers.

4.4.8 F Centers

The name F comes from German word Faber means color. The F centers are produced by heating a crystal in presence of excess alkali vapour or by X Ray irradiation. When excess alkali atoms are added to alkali halides crystal, a number of negative ion vacancies are created. The valance electrons of alkali atom migrate in the crystal, and bound with vacant negative ion sites on at vacancies. The F centers are identified by electron spine resonance as electrons are bound at negative ion vacancies. This model was first suggested by de Boer. The central optical absorption band (F band) associated with F centers of some alkali halide is shown in figure 4.4.

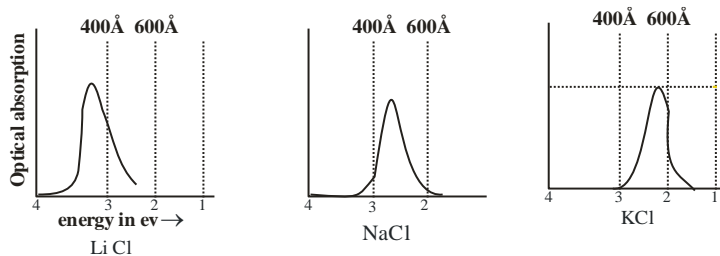

Figure 4.4: F band of some alkali Halides

4.5 LINE DEFECT (Linear Dislocation)

Line defects are defect along a line which ends on the surface of the crystal. In such defects the atoms are displaced from their normal position along a line and causes strains which spread over the volume of crystal. When a stress force is applied on a crystal, the crystal is deformed elastically and it returns to its original state after removal of stress force. But, if the stress is sufficiently high, a certain amount of deformation remains after removal of stress. Such type of plastic deformation in which atoms are dislocated from original position are called dislocation. In such defects, a linear chain of atoms slide from one part of crystal to another.

The line defect is characterized by Burgers vectors. Burger vector (b) whose direction and magnitude can be determined by constructing a loop around the disrupted region and noticing the extra inter atomic spacing needed to close the loop.

A crystal structure is a regular arrangement of atom in a perfect manner. However, a defect can occur in the sequence of arrangements of atom. There may be an addition layer of atoms or may be missing of a layer. These distortions cause linear defects or dislocations in crystal structure. Usually a crystal contains a high concentration of dislocation. There are three types of dislocation as:

4.5.1 Edge Dislocation

To understand the edge dislocation, consider a two-dimensional crystal arrangement as shown in figure 4.5. If there is the presence of an extra half row of atom it is called edge dislocation. The edge dislocation is characterized by Burgers vector, named after Dutch physicist Jan Burger, is a vector that represents the magnitude and direction of lattice distortion.

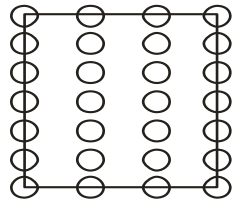

Figure 4.5(a): ideal crystal

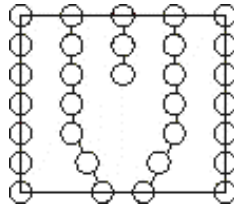

Figure 4.5(b): edge dislocation

Similarly, in 3D case, edge dislocation is defined as the presence of an extra half plane of atoms in the crystal. In edge dislocation has its Burgers vector perpendicular to dislocation line. The deformation is along the edge of extra half plane and called edge dislocation. Now we try to understand the geometry of edge dislocation in three-dimensional case as shown in figure 4.6.

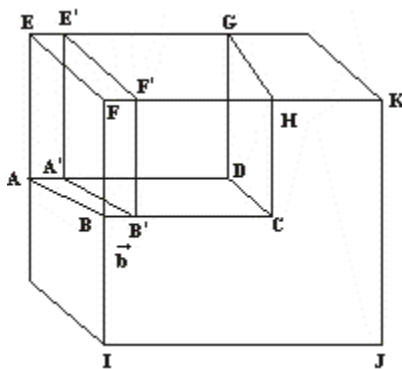

Figure 4.6(a): Edge dislocation

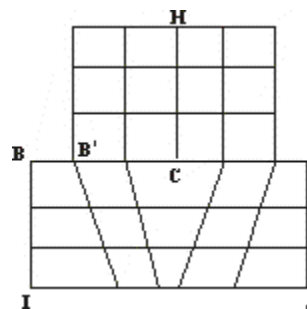

Figure 4.6(b): HC extra half plane

Now consider a simple cubic crystal as shown in figure 4.6(a). The atoms are bound to each other in the crystal structure. Now we consider an imaginary experiment. Now, the crystal is cut along the direction ABCD just at the half of crystal. Now the planes above and below two ABCD are disconnected. Now we apply a shear force on the above half of crystal. After the effect to this push the upper half is slipped such that ABEF plane is displaced by \vec{b} which is initially at ABEF. If the position of two half were aligned again as shown in figure 4.6 (b), then an extra half plane HC is produced in the crystal structure. It is clear that CD is the edge of extra half plane which is called edge dislocation line. The deformation is only along

dislocation line. Figure 4.6 (b) represent the point view of crystal section FIJK. In this figure HC represents the rows of atoms on the plane perpendicular to the plane of paper. Vector \mathbf{b} represents the amount and direction of crystal structure distortion which is Burgers vector.

Positive and negative edge dislocation:

Consider a square network of lines which represents the arrangements of atoms in a regular manner as shown in figure 4.7.

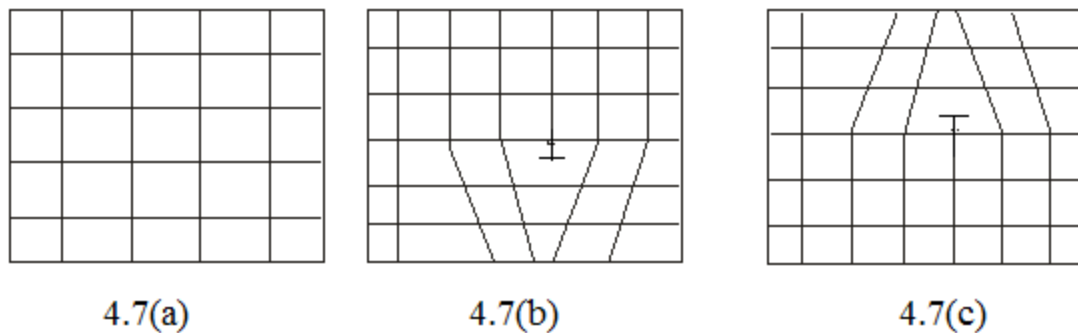

Figure 4.7: Positive and negative dislocations

Edge dislocation for which the extra half plane lies above or in upper half, then it is called positive edge dislocation and are denoted by \perp as shown in figure 4.7 (b). Similarly, if the extra half plane is situated in the lower half of crystal, that is below the slip plane, then the dislocation is called negative edge dislocation ∇ as shown in figure 4.7 (c).

4.5.2 Screw Dislocation

As we study earlier, in case of edge dislocation burger vector \mathbf{b} is perpendicular to dislocation line ($\bar{b} \perp \hat{t}$). But in case of screw dislocation, Burgers vector \mathbf{b} is parallel to dislocation line ($\bar{b} \parallel \hat{t}$). To understand the geometry of screw dislocation, consider a cubic crystal as shown in figure 4.8. The crystal is divided into two parts, left half and right half. A boundary LM divided two half as left slip and right slip.

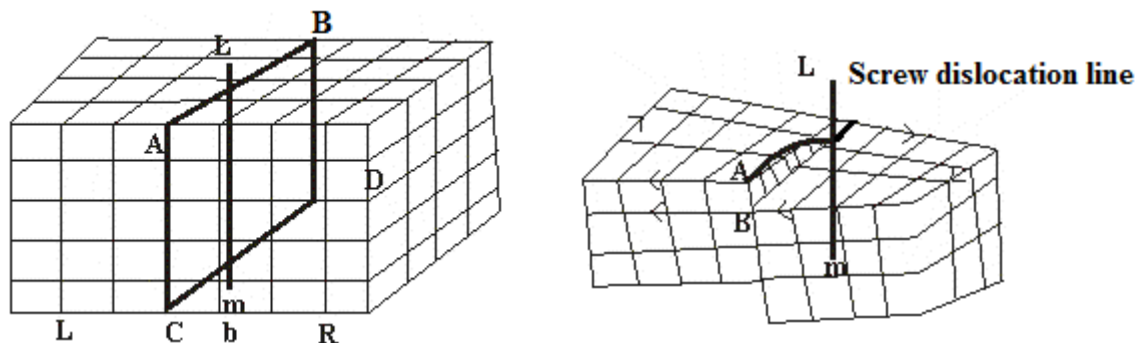

Figure 4.8: Screw dislocation

Now we slip the right slip by an amount \mathbf{b} along the direction LM. In screw dislocation if we draw a circuit along the corner of plane as shown in figure 4.8 by arrow we can see on moving clockwise direction starting from point A, then after completing a complete circuit we will reach in the next to lower plan at point B. Thus the discrete parallel planes perpendicular to the dislocation line join to form a continuous spiral ramp with dislocation line as axis of spiral ramp.

4.5.3 Mixed Dislocation

It has been discussed that in edge dislocation the Burgers vector is perpendicular to dislocation line ($\bar{b} \perp \hat{t}$). On the other hand in case of screw dislocation the Burgers vector is parallel to dislocation line ($\bar{b} \parallel \hat{t}$). But in more general case, the Burgers vector is neither perpendicular nor parallel to dislocation line. This is called mixed dislocation. In this case the dislocation line is not straight line due to stress. A straight line dislocation required a lot of energy to maintain its bond in crystal. Therefore, crystal has a tendency to be in low energy configuration by bending the dislocation line. The mixed dislocations are generally bend, irregular with curved dislocation line. The mixed dislocation is result of external stress which plastically deformed the crystal.

4.5.4 Observation of Dislocation

The dislocations can be observed by different experimental techniques as given below.

- (1) X ray diffraction method
- (2) Transmission electron microscopy
- (3) Surface methods

By X-ray diffraction method we can determine the location and its density.

4.6 SURFACE DEFECTS

Surface defects are also known as planar defect or interfacial defects. They are boundaries that have two dimensions and normally separate regions of crystal that have different orientation. Surface defects arise from clustering of line defects into a plane. These defects are not thermodynamically stable rather they are metastable. Surface defects are basically two types external and internal. The internal surface defects are again of four types as given below:

- (1) Grain boundaries
- (2) Tilt boundaries
- (3) Twin boundaries
- (4) Stacking fault and phase boundaries.

4.6.1 External Surfaces

The external surface of crystal marks the ending of crystal in structure where the atoms have neighbours on one side only. However, the atoms inside the crystal have neighbours on other sides. The unsaturated bonds of surface atoms give rise to the surface energy. This results relaxation and reconstruction of crystal structure. To reduce energy, the crystal tends to minimize surface area and surface imperfection arises.

4.6.2 Grain Boundaries

Grain boundaries are interface surfaces between two crystal grains of same phase but different orientations as shown in figure 4.9. Figure 4.9 shows two grains of crystal which is separated by a grain boundary. In most of the crystal, there are polycrystals and there are multiple boundaries as shown in figure 4.10. When a crystal is solidified from liquid, the crystal starts formation at different regions of liquids. The orientation of crystal formed at different point of liquid are different and therefore grain boundaries arises. Grain boundaries affect the properties of poly crystalline material. The grain boundaries affect mechanical properties dielectric and optical properties of solids.

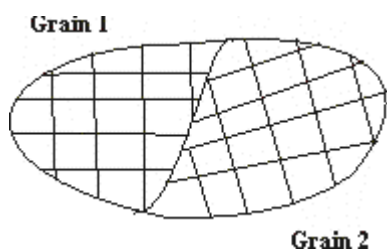

Figure 4.9: Grain boundaries of two crystal grains

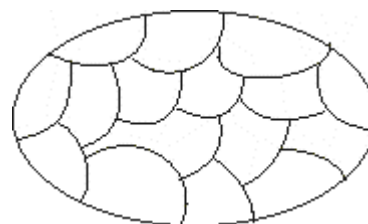

Figure 4.10: Grain boundaries of polycrystalline solid

Based on the rotation of axis with respect to grain boundary, the grain boundaries are classified into two main groups as tilt boundary and twist boundary.

(i) Tilt Boundary:

In case of tilt boundary the rotation axis is parallel to boundary plane as shown in figure 4.11(a). In figure 4.11(a) there are two grains of two side of boundary represented by LM which is a plane perpendicular to the paper. If we want to get the orientation of grain 2 from grain 1 we just rotate the grain 1 about an axis perpendicular to plane of paper. Since the boundary is perpendicular to plane of paper and axis of rotation is also perpendicular to the plane of paper therefore the axis of rotation is parallel to the plane of boundary.

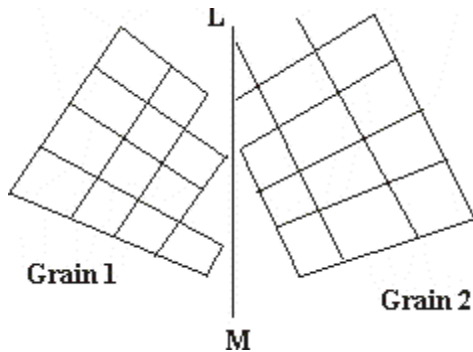

Figure 4.11(a): Tilt Boundary

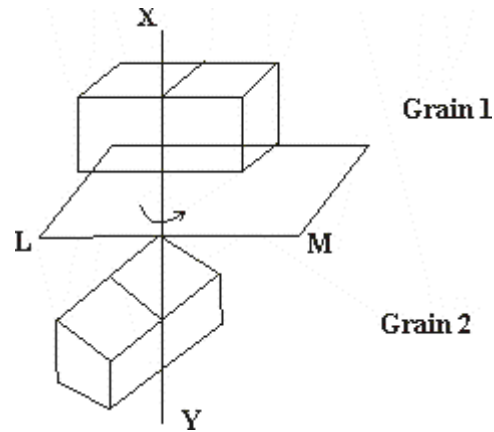

Figure 4.11(b): Twist Boundary

(ii) Twist Boundary:

In this case the angle of rotation is perpendicular to the plane of boundary as shown in figure 4.11(b). We can see that the orientation of grain 2 can be obtained by rotating the grain 1 about the axis XY.

(iii)Twin Boundary:

This is a special type of grain boundary across which the atomic arrangement of one side of boundary is mirror reflection of atomic arrangement of other side. Twin boundaries occur in pairs such that orientation change introduced in one side is restored by other. Figure 4.12 shows twin boundary.

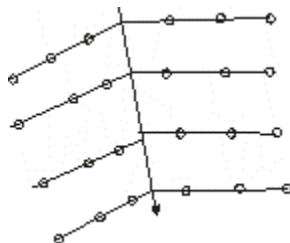

Figure 4.12: Twin Boundary

(iv) Stacking fault:

The stacking fault is surface defect that arise from the stacking of one atomic plane out of sequence on another. For example in FCC crystal the ideal sequence is ABC, ABC, ABC, ABC..... But due to stacking fault, there is an interruption in the stacking sequence as ABC, ABC, ABC, ABC, ABC, BC, ABC..... . This is called stacking fault.

(v) Phase boundary:

Phase boundaries exist in multiphase crystal across which there is a sudden change in physical and chemical characteristics.

4.7 VOLUME DEFECTS

Volume defects are also known as 3D defects. They are normally introduced during the process of crystal formation. They manifest themselves, microscopically as pores and cracks.

4.8 SUMMARY

1. All deviations from the specified ordered periodicity are called defects or imperfections. If a crystal does not possess defects, then it is called ideal crystal

2. Point defects are simplest imperfection in crystal. In such type of defects an atom involves individually and therefore called zero dimension (0D) defect. The point defect is generally three types as vacancies, interstitial and impurity.

3. At vacancies, atoms are absent from its regular atomic positions. These vacancies are also known as Schottky defect. If an atom of crystal leaves its site, create a vacancy and fit interstitial, is known as Frenkel defect.

4. At equilibrium the number of vacancies can be given as

$$N_v = N \exp\left(-\frac{Q_v}{kT}\right)$$

5. The concentration of Schottky defects in metallic crystal $\frac{n}{N} = e^{-E_v/kT}$

6. The concentration of Frenkel defects in metallic crystal $n = \sqrt{N N_i} \cdot e^{-E_f/2kT}$

7. The flux J_N of impurities or vacancies in a crystal is given by Fick's law given as

$$J_N = -D \text{ grad } N = -D \cdot \frac{dN}{dx}$$

Then D can be given as $D = v a^2 \cdot \exp(-E/kT)$

8. Line defects are defect along a line which ends on the surface of the crystal.

9. In Plastic deformation atoms are dislocated from original position are called dislocation. In such defects, a linear chain of atoms slide from one part of crystal to another.

4.9 GLOSSARY

Defect: a shortcoming, imperfection, or lack in crystal structure

Interstitial: situated within

Substitutional: substituting or replacing one atom or thing with another

Diffusion: process resulting from random motion of defects by which there is a net flow from a region of high concentration to a region of low concentration

Dislocation: Line defects in solids

Grain boundary: A *grain boundary* is the interface between two grains, or crystallites, in a polycrystalline material.

Tilt: move or cause to move into a sloping position.

Twist: form into a bent, curling, or distorted shape.

Stacking: arrange (a number of things) in a pile.

4.10 REFERENCES

1. Charles Kittel, Introduction to Solid State Physics, Wiley Eastern Limited 5th ed. 1976
2. H. C. Gupta, Solid State Physics, Visas Publishing House Private Limited 1995
3. M Laminata Rao, course -3 Solid State Physics, Dr B R Ambedkar Open University, Hyderabad 2008.

4.11 SUGGESTED READINGS

1. A. J. Dekkar, Solid State Physics, The Macmillan Press Ltd. 1981
2. J. Callaway, Quantum Theory of the Solid State, Part A & B, Academic Press, New York (1974)
3. R. Kubo and T. Nagamiya, Solid State Physics, McGraw-Hill, New York (1969). 1992
4. Uichiro Mizutani, Introduction to the Electron Theory of Metals, Cambridge University Press, 2014.

4.12 TERMINAL QUESTIONS

4.12.1 Short answer type questions

1. What do you mean by imperfections in crystals? Classify the different types of imperfections.
2. Explain various types of point defects.
3. What are Schottky and Frenkel defects?
4. What are color centers? Explain the F centers in ionic crystals.
5. Explain the reason for existence of color centers.
6. How color centers can be produced in an ionic crystal.
7. What are V centers? Explain the model for V centers and its properties.

8. What are the applications of color centers?
9. What is diffusion? State and explain Fick's law of diffusion.
10. Explain the dislocation in crystal?
11. Explain edge dislocations.
12. Explain screw dislocation with the help of diagram.
13. What are mixed dislocations?
14. What is Burger vector?
15. What are grain boundaries?
16. Explain the difference between tilt and twist boundary.

4.12.2 Long answer type questions

1. Explain the Schottky defect and find out the expression for equilibrium concentration of Schottky defects in a metallic crystal. How does the expression change for ionic crystal?
2. Obtain the expression for equilibrium concentration of vacancies in a metallic crystal.
3. Explain the Frenkel defect and find out the expression for equilibrium concentration of Frenkel defects in a metallic crystal.
4. What are dislocations? Classify different types of dislocations. Explain edge and screw dislocations with the help of diagram.
5. What are edge and screw dislocations? Explain with the help of diagram.

UNIT 5**CRYSTAL VIBRATIONS**

Structure

- 5.1 Introduction
- 5.2 Objective
- 5.3 Crystal Vibration for monatomic chain of atoms
 - 5.3.1 Brillouin zone
 - 5.3.2 Group velocity
 - 5.3.3 Derivation of force constants
- 5.4 Crystal Vibration for diatomic chain of atoms
- 5.5 Quantization of elastic waves and phonon
 - 5.5.1 Phonon momentum
- 5.6 Inelastic scattering by phonon
- 5.7 Summary
- 5.8 Glossary
- 5.9 References
- 5.10 Suggested reading
- 5.11 Terminal questions

5.1 INTRODUCTION

When we see a crystalline solid, it seems all atoms or molecules of the lattice are fixed and there is no any motion. But in actual, all the constituents of crystal lattice are vibrating regularly. These vibrations are in atomic level and can be understood with the application of quantum mechanics. These type motions are called crystal vibrations or lattice vibrations, and dynamics of lattice is called lattice dynamics. The wave associated with crystal vibrations is called elastic wave. The energy associated with the lattice vibration is also quantized like electromagnetic energy, charge etc. The quanta of lattice vibrations or elastic wave are called phonon. Figure 4.1 shows the quantization of different types of waves or yields and their quanta.





Name of field/wave associated	Quanta unit of energy	Symbol
Electromagnetic wave	Photon	
Elastic wave (lattice vibration)	Phonon	
Collective electron wave	Plasmon	
Magnetization wave	Magnon	
Electron + Electric deformation	Polaron	-
Polarization wave	Exciton	-

Figure 5.1: Different types of excitations in solids

In this unit we will understand the vibrations of crystal lattice and find out the dispersion relation. Since crystal vibration are significant to understand the different properties of solids like thermal, electrical, mechanical, magnetic or superconducting properties can be described in terms of continuum theory disregarding the atomic structure of lattice. In this

chapter we make a basic understand of lattice vibration, elastic wave, quantization of elastic wave, energy associated with wave, phonon and phonon momentum etc.

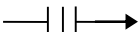
5.2 OBJECTIVE

After reading this unit we will able to understand

- (i) Lattice vibration
- (ii) Lattice vibration of monatomic or diatomic basis
- (iii) Dispersion relations
- (iv) Group velocity, phase velocity, quantization of elastic waves
- (v) Phonon and Phonon momentum

5.3 CRYSTAL VIBRATION for MONATOMIC CHAIN of ATOMS

Consider a crystal with one atom in each primitive cell. For simplicity we consider a case of simple cubic crystal. We are interested in the elastic vibration of this crystal lattice. We want to calculate the frequency of elastic wave occurs in a simple cubic lattice. We know, the atoms are arranged in the different crystal planes, and some planes are [100], [110], [111] etc which are the directions of cube edge along yz plane, perpendicular to face diagonal of xy plane and Plane along body diagonal of cube respectively as shown in figure 1.17 in first unit. When an elastic wave propagates along any one direction of these Planes, entire system of planes consisting atoms displaced in phase, with displacements either parallel or perpendicular to direction of propagation. For simplicity, we consider one dimensional case, and $s, s+1, s+2 \dots s-1, s-2 \dots$ are the number of planes and u_s is the displacement of s^{th} plane from its equilibrium position as shown in figure 5.2.

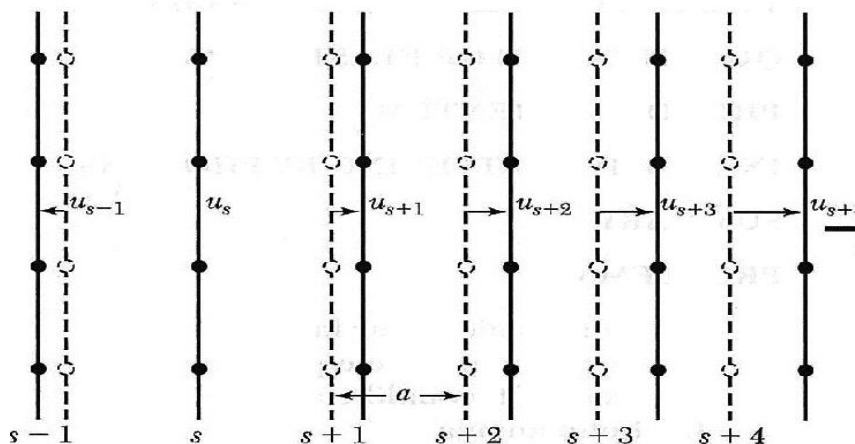

Figure 5.2: Displacements of different atoms in lattice vibration. Dotted lines are the positions of atom at equilibrium and bold lines are position of displaced atom with displacement of u_s

Let us consider u_s is the displacement of s^{th} plane from its equilibrium. Similarly the displacement of $(s+1)^{\text{th}}$ plane is u_{s+1} and displacement of $(s-1)^{\text{th}}$ plane is u_{s-1} as shown in figure 5.2. s is integer number shows the number of plane. In figure 5.2, the bold lines show the equilibrium positions of planes and dashed lines show the displacements of planes from equilibrium positions. In lattice vibration, we assume that the elasticity of lattice is linear function of force acts on planes. The vibrations allow Hook's law and force (or energy) will vanish in equilibrium position at which displacement becomes zero ($F = -kx$).

Thus the total force on s^{th} plane is the force due to nearest $s+1$ and $s-1$ planes, and given us

$$F_s = C (u_{s+1} - u_s) + C(u_{s-1} - u_s) \quad (5.1)$$

Where C is the force constant for crystal planes which is different for longitudinal and transverse directions of lattice vibrations.

The equation of motion for s^{th} plane can be given as

$$M \frac{d^2 u_s}{dt^2} = C(u_{s+1} + u_{s-1} - 2u_s) \quad (5.2)$$

Where M is the mass of an atom. Equation (5.2) is second order different equation and the solution of such different equation for plane wave can be given us

$$u_s = u_0 e^{i(kas - \omega t)} \quad (5.3)$$

This is the solution of travelling wave in terms of wave vector k and angular frequency ω . a is lattice constant, s is integer number shows the number of plane and u_0 is constant .

Now, differentiate equation (5.3) two times we get

$$\frac{d^2 u_s}{dt^2} = -\omega^2 u_0 e^{i(kas - \omega t)} \quad (5.4)$$

Putting this value of u_s and $\frac{d^2 u_s}{dt^2}$ in equation (5.2)

$$-M\omega^2 u_0 e^{i(kas - \omega t)} = C [u_0 e^{i(ka(s+1) - \omega t)} + u_0 e^{i(ka(s-1) - \omega t)} - 2u_0 e^{i(kas - \omega t)}]$$

$$\text{Or } -M\omega^2 = C[e^{i ka} + e^{-i ka} - 2]$$

We know the identify

$$e^{i ka} + e^{-i ka} = 2 \cos ka$$

Putting this value in above equation

$$-M\omega^2 = C[2 \cos ka - 2] \text{ or } \omega^2 = \frac{2C}{M}(1 - \cos ka) \quad (5.5)$$

$$\omega^2 = \frac{2C}{M} \left(1 - 2 \sin^2 \frac{ka}{2} - 1\right)$$

$$\omega = \sqrt{\frac{4C}{M}} \sin \frac{ka}{2} \quad (5.6)$$

The plot of ω and wave vector k is shown in figure 5.3. For simplicity, we plot curve $\frac{\omega}{\sqrt{4C/M}}$ versus ka . The range of k is physically significance for elastic waves. The boundary lies at $k = \pm \frac{\pi}{a}$ is nothing but first Brillouin zone thus called first zone boundary. At zone boundary, the value of $\sin \frac{ka}{2} = \sin 90^\circ = 1$ thus $k = \pm \frac{\pi}{a}$. It is clear from the figure 5.3, at zone boundaries the slop of ω verses k becomes zero.

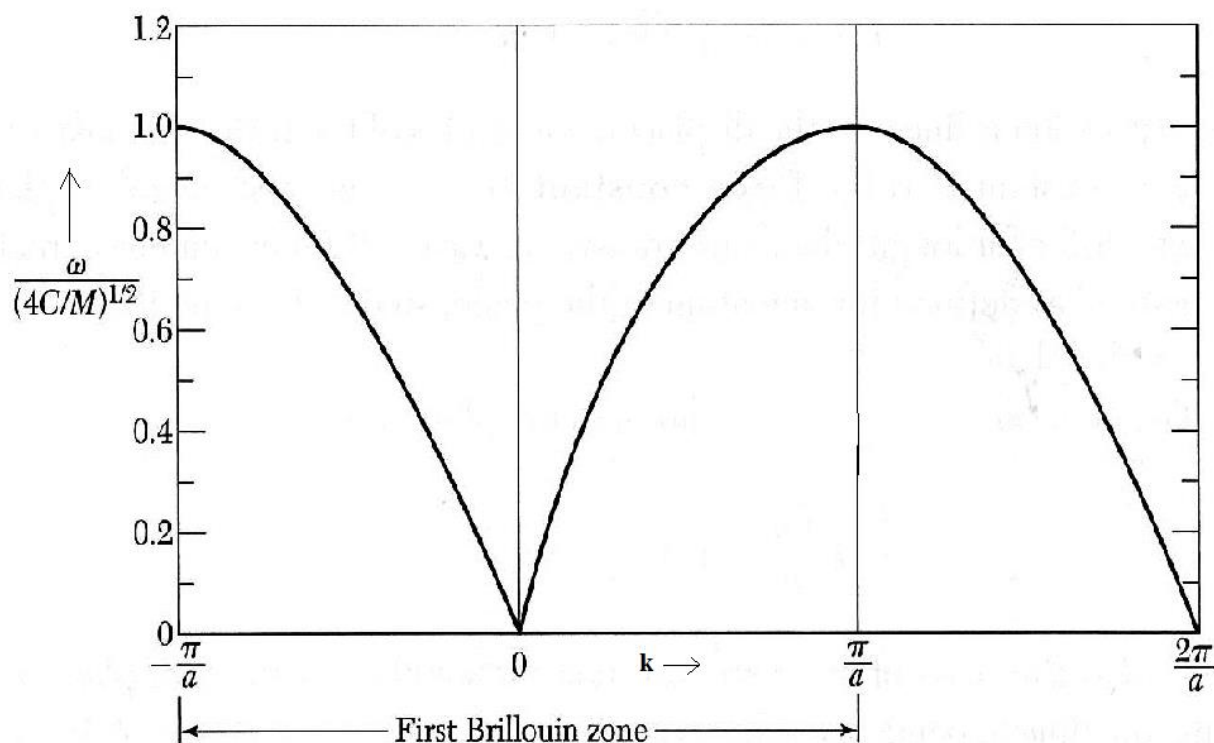

Figure 5.3: Variation of ω and wave vector k .

From equation (5.6) it is clear that the maximum frequency $\omega_m = \sqrt{\frac{4C}{M}}$ which is called natural cut off frequency of linear chain of atom in a solid. Corresponding to ω_m , maximum value of ω , $\frac{ka}{2}$ equal to odd multiple of $\frac{\pi}{2}$ or $k = \pm \frac{\pi}{a}$ which is called zone

boundaries. The ω becomes 0 corresponding to $\frac{ka}{2} = \pi$ or $k = \frac{2\pi}{a}$. In phonon dispersion relation shown in figure 5.3 and wave formation is shown in figure 5.4. Now, we discuss different cases based on different values of k .

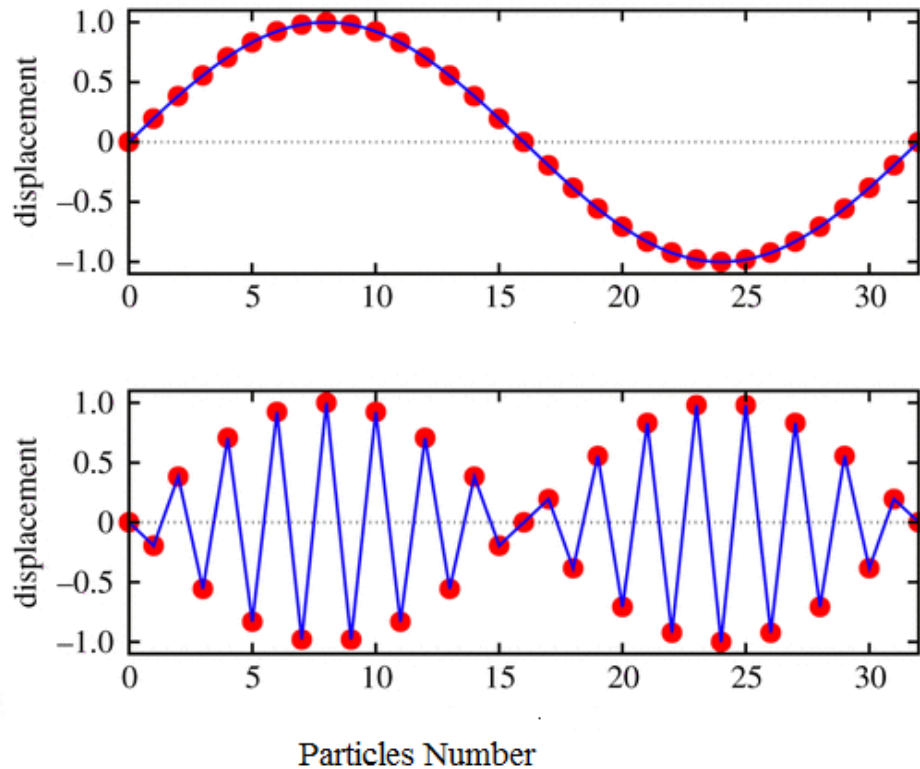

Figure 5.4: Wave formation in the lattice

(i) At low frequencies: In this case of low frequencies, when value of k is small with comparison to inter atomic distance of solid a , the value of wavelength λ becomes high which is called long wavelength limit. In this condition

$$\omega \rightarrow 0 \text{ or } k \rightarrow 0 \text{ then } \lambda \rightarrow \infty \text{ (high)}$$

$$\text{then } \sin \frac{ka}{2} \approx \frac{ka}{2} \text{ (for small values of } \sin \theta \text{)}$$

Then eq. (5.6) can be given as

$$\omega = \sqrt{\frac{4C}{M} \frac{ka}{2}} = ka \sqrt{\frac{C}{M}} \text{ or } \omega \propto k \quad (5.7)$$

Thus for long wavelength limit, the frequency ω is proportional to wave vector k and dispersion is very small and atoms in solid behaves as homogeneous medium. In

this condition the phase velocity and group velocity is same as for homogeneous (non dispersive medium) medium.

$$\text{Thus phase velocity } v_p = \frac{\omega}{k} = a \sqrt{\frac{c}{M}} = v_s \quad (5.8)$$

Where v_s is nothing but the velocity of sound.

Similarly, the group velocity of elastic wave can be given

$$v_G = \frac{d\omega}{dk} = a \sqrt{\frac{c}{M}} = v_s \quad (5.9)$$

Therefore for long wavelength limit, the phase velocity and group velocities are same and equal to velocity of sound. The order of frequency in low frequency range is $\approx 10^{13}$ Hz which is acoustic waves range. In this range of low frequency the non-dispersive medium behave as homogeneous continuum. In figure 5.3, curve represents continuum lattice. For elastic continuum $\omega = v_s k$ and for phonon dispersion $\omega = \sqrt{\frac{4C}{M}} \cdot \sin \frac{ka}{2}$, but as $k \rightarrow 0$ both are coincide.

(ii) At high frequency: At high frequencies there is no proportionality relation between ω and k as given by equation (5.7). In this condition dispersion becomes significant. In this region the system of atoms in lattice behaves as non homogeneous. In this frequency range, the curve becomes sinusoidal as given by equation (5.8).

In this region the phase velocity and group velocity are different and can be given as

$$v_p = \frac{\omega}{k} = \frac{\sqrt{\frac{4C}{M}} \sin \frac{ka}{2}}{k} = \frac{v_s \sin \frac{ka}{2}}{\frac{ka}{2}} \quad (5.10)$$

Group velocity

$$v_g = \frac{d\omega}{dk} = \frac{d}{dk} \left(\sqrt{\frac{4C}{M}} \sin \frac{ka}{2} \right)$$

$$v_g = \sqrt{\frac{4C}{M}} \cdot \frac{a}{2} \cos ka = v_s \cos \frac{ka}{2} \quad (5.11)$$

(iii) At maximum value of frequency: In the case of maximum frequencies which is called natural cut off frequency $\omega_m = \sqrt{\frac{4C}{M}}$, the minimum wavelength can be obtained as

$$k_{max} = \pm \frac{\pi}{a} \text{ or } \frac{2\pi}{\lambda_{min}} = \pm \frac{\pi}{a}$$

$$\lambda_{min} = \pm 2a \quad (5.12)$$

(iv) Brillouin Zone:

From equation (5.6) it can be observed that at value $k = \frac{\pi}{a}, \frac{3\pi}{a}, \frac{5\pi}{a}$ maximum cutoff ω_m is obtained. Similarly at $k_n = k = \frac{2\pi n}{a}$ always give the some lattice vibrational states (where n is any integer number. $n = 1, 2, 3 \dots$). The region between $k = +\frac{\pi}{a} to -\frac{\pi}{a}$ is called first Brillouin zone. Similarly the region between $+\frac{\pi}{a} to +\frac{3\pi}{a}$ and $-\frac{\pi}{a} to -\frac{3\pi}{a}$ of k values both side of first Brillouin zone, is called second Brillouin zone. Since the value of v_g becomes zero at zone boundaries ($k = \pm \frac{\pi}{a}$) as given by equation (5.11) therefore no energy propagation at zone boundaries and the wave becomes stationary.

Thus the displacement of n^{th} atom at the boundary can be given as

$$x_n = Ae^{i(\omega t - ka_n)} \quad (5.13)$$

at boundary $ka_n = \pm n\pi$

$$\text{and } x_n = Ae^{i(\omega t \pm n\pi)} \quad (5.14)$$

(v) Density of State:

As we discussed ω is a periodic function with several value of k less than ω_m . If the boundaries of linear chain of atoms are fixed, then there should be an integral number of half wave lengths in the linear chain as $L = n \frac{\lambda}{2}$ where $n = 1, 2, 3, \dots N$

and wave vector can be given as $k = \frac{2\pi}{\lambda} = \frac{2\pi}{\frac{2L}{n}} = \frac{n\pi}{L}$

$$k = \frac{\pi}{L}, \frac{2\pi}{L}, \frac{3\pi}{L} \dots \frac{n\pi}{L}$$

The density of state $D(k)$ is defined as the number of states per unit wave number as

$$D(k) = \frac{dN}{dk} = \frac{1}{\frac{\pi}{L}} = \frac{L}{\pi} \quad (5.15)$$

as 1 state corresponding to each wave vector $\frac{\pi}{L}$.

Total number states can be given as

$$dN = D(k)dk = D(\omega)d\omega \quad (5.16)$$

$$\text{Or } D(\omega) = \frac{D(k)dk}{d\omega} = \frac{D(k)}{\frac{d\omega}{dk}} = \frac{L}{\pi.v_g}$$

This fraction is useful in the calculation of energy and specific heat of solids.

5.4 CRYSTAL VIBRATION OF DIATOMIC LINEAR CHAIN OF ATOMS

The phonon relation becomes different from previous if two or more atoms are in a primitive cell. We can consider a crystal of diatomic molecule like NaCl or diamond. Let us consider a cubic crystal of diatomic molecule in a linear chain, in which atoms of masses M_1 and M_2 are separated by a lattice distance a as shown in figure 5.5. We can consider the atoms are connected by a virtual spring of force constant C . The displacement of atoms M_1 are denoted by $u_{s-1}, u_s, u_{s+1}, u_{s+2} \dots$ and the displacement of atoms M_2 are $v_{s-1}, v_s, v_{s+1}, v_{s+2} \dots$ where s is any interger number ($s = 1, 2, 3, \dots$) represents the number of atom.

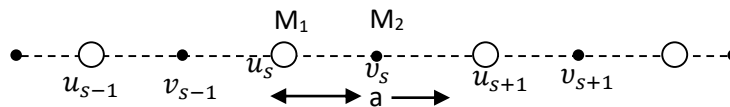

Fig. 5.5 Diatomic molecular chain

We consider that waves propagate in a symmetric direction for which a plane contains one type of atom and such direction are $[111]$ or $[100]$ etc. If the atoms interact with neighbour atoms, only then the equations of motion can be given as

$$M_1 \frac{d^2 u_s}{dt^2} = C(v_s + v_{s-1} - 2u_s) \quad (5.17a)$$

$$M_2 \frac{d^2 v_s}{dt^2} = C(u_{s+1} + u_s - 2v_s) \quad (5.17b)$$

Where C is force constant of lattice system.

This is a second order differential equations show the travelling wave and the solution can be given as

$$u_s = u_e^{i(kas - \omega t)} \quad (5.18a)$$

$$v_s = v_e^{i(kas - \omega t)} \quad (5.18b)$$

Here s is any integer number represents the number of plane.

Differentiate above equation (5.18) two times and put the value in eq. (5.17) we will get

$$-\omega^2 M_1 u = C v (1 + e^{-i ka}) - 2C u$$

$$-\omega^2 M_2 v = c u (e^{i ka} + 1) - 2C v$$

$$\text{or } (2c - M_1 \omega^2) u - C(1 + e^{i ka}) v = 0$$

$$-C(1 + e^{i ka}) u - (2C - M_2 \omega^2) v = 0$$

The solutions of above equations exist only if determinant of coefficients of unknown variables u and v vanishes thus

$$\begin{vmatrix} 2C - M_1 \omega^2 & -C(1 + e^{-i ka}) \\ -C(1 + e^{i ka}) & 2C - M_2 \omega^2 \end{vmatrix} = 0$$

On solving the determinant

$$(2C - M_1 \omega^2)(2C - M_2 \omega^2) - C^2(1 + e^{i ka})(1 - e^{-i ka}) = 0$$

$$4C^2 + M_1 M_2 \omega^4 - 2C M_2 \omega^2 - 2C M_1 \omega^2 - C^2(1 + e^{-i ka} + e^{i ka} + 1 + e^{i ka - i ka}) = 0$$

$$\text{or } 4C^2 + M_1 M_2 \omega^4 - 2C \omega^2 (M_2 + M_1) - C^2(2 + 2 \cos ka) = 0$$

$$\text{or } M_1 M_2 \omega^4 - 2C \omega^2 (M_2 + M_1) + 2C^2(1 - \cos ka) = 0 \quad (5.19)$$

$$\text{or } \omega^4 - \frac{2C(M_1 + M_2)}{M_1 M_2} \omega^2 + \frac{4C^2 \sin^2 ka/2}{M_1 + M_2} = 0 \quad (5.20)$$

This is the quadratic equation on ω^2 and its solution can be given as

$$\omega^2 = \frac{C(M_1 + M_2)}{M_1 M_2} \pm \frac{1}{2} \sqrt{\frac{4C^2(M_1 + M_2)^2}{M_1^2 M_2^2} - \frac{4C^2 \cdot 4 \sin^2 ka/2}{M_1 M_2}} \quad \left[\because a s x = \frac{-b \pm \sqrt{b^2 - 4ac}}{2a} \right]$$

$$\omega^2 = C \left(\frac{1}{M_1} + \frac{1}{M_2} \right) \pm C \left[\left(\frac{1}{M_1} + \frac{1}{M_2} \right)^2 - \frac{4 \sin^2 ka/2}{M_1 M_2} \right]^{1/2} \quad (5.21)$$

Equation (5.21) represents the relation between ω frequency and wave vector k for diatomic linear chain of atoms. It is clear from the equation, for any value of k we get two values, positive and negative value of ω^2 , and represented as ω_+^2 and ω_-^2 . For simplification we examine limiting case as $ka \ll 1$ then $\sin ka \approx ka$.

5.4.1 Acoustic and Optical Phonon

According to equation (5.21), if we use negative sign in expression of ω^2 , we get ω_-^2 value, which gives minimum value of frequency which is called acoustic phonon. The order of frequency of acoustic phonon is same as the frequency of acoustic waves therefore these phonons are called acoustic phonon. Figure 5.6 show the acoustic branch

of phonon. On the other hand if we use positive sign in the equation (5.21), we get the maximum value of ω_{\pm}^2 and the waves are called optical phonon. The order of frequency of optical phonon is same as the frequency of light waves. The optical branches of phonon are also shown in the figure 5.6. The range of frequency of optical branch of wave are order of optical range of electromagnetic wave thus the vibration of crystal lattice, optical branch can be excited with the help of electromagnetic waves of optical regions.

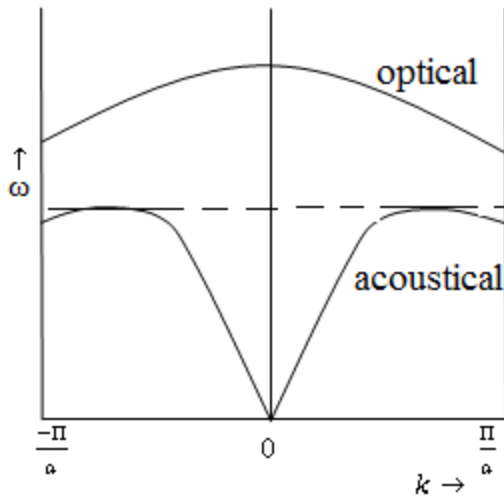

Figure 5.6: Dispersion relation of [111] direction of germanium crystal

For simplification we can discuss the limiting case $k \rightarrow 0$ of acoustic and optical branches.

(1) Optical Branch:-

When $k=0$ then eq. (5.21) given the value of ω_{\pm}^2 as

$$\omega^2 = C \left(\frac{1}{M_1} + \frac{1}{M_2} \right) \pm C \left[\left(\frac{1}{M_1} + \frac{1}{M_2} \right)^2 - 0 \right]^{\frac{1}{2}}$$

$$\omega^2 = C \left(\frac{1}{M_1} + \frac{1}{M_2} \right) \pm C \left(\frac{1}{M_1} + \frac{1}{M_2} \right)$$

$$\omega_{\pm}^2 = 0$$

$$\text{and } \omega_{\pm}^2 = 2c \left(\frac{1}{M_1} + \frac{1}{M_2} \right) \quad \text{Optical Branch} \quad (5.22)$$

(2) Acoustic Branch:-

When k is very small $k \rightarrow 0$ then

$\sin \frac{ka}{2} \approx \frac{ka}{2}$ then equation (5.21) becomes

$$\begin{aligned}\omega^2 &= C \left(\frac{1}{M_1} + \frac{1}{M_2} \right) \pm C \left[\left(\frac{1}{M_1} + \frac{1}{M_2} \right)^2 - \frac{4 \left(\frac{ka}{2} \right)^2}{M_1 M_2} \right]^{\frac{1}{2}} \\ &= C \left(\frac{M_1 + M_2}{M_1 M_2} \right) \pm C \left[\left(\frac{M_1 + M_2}{M_1 M_2} \right)^2 - \frac{k^2 a^2}{M_1 M_2} \right]^{\frac{1}{2}} \\ \omega^2 &= C \left(\frac{M_1 + M_2}{M_1 M_2} \right) \left[1 \pm \left(1 - \frac{k^2 a^2 M_1 M_2}{(M_1 + M_2)^2} \right)^{\frac{1}{2}} \right]\end{aligned}$$

Using binomial theorem and taking negative value for acoustic range.

$$\begin{aligned}\omega^2 &= C \left(\frac{M_1 + M_2}{M_1 M_2} \right) \left[1 \pm \frac{1}{2} \left(1 - \frac{k^2 a^2 M_1 M_2}{(M_1 + M_2)^2} \right) \right] \\ \omega_-^2 &= \frac{c}{M_1 + M_2} k^2 a^2\end{aligned}\tag{5.23}$$

Acoustic Branch is denoted by negative sign as ω_-^2 .

In dispersion relation each mode in a given propagation direction, develops two branches known as optical and acoustic branches. Further, these branches are two types as Longitudinal Acoustic (LA) and Transverse Acoustic (TA) modes and Longitudinal optical (LO) and Transverse optical (TO). If there are p atoms in a primitive cell, then there are $3p$ branches of dispersion relation. There are 3 acoustic branches and $(3p - 3)$ optical branches. Figure 5.6 shows the LA, TA, LO, TO branches of germanium. Germanium atom has 2 atoms in a primitive cell, thus it has 3 optical, and 3 acoustic branches. Out of there 6 branches it has one LA, two TA, one LO, two TO.

As we discussed earlier the first Brillouin zone is extended from $-\frac{\pi}{a}$ to $+\frac{\pi}{a}$, where a is lattice parameter for diatomic crystal lattice. It is clear from equation (5.21), at $k = \pm \frac{\pi}{a} = k + \frac{m\pi}{a}$, we get same values of ω . Thus at interval of $\frac{m\pi}{a}$, the value of ω repeats. Therefore in this range of $-\frac{\pi}{a}$ to $+\frac{\pi}{a}$ provide the limits of ω which is Brillouin zone. At $k = \pm \frac{\pi}{a}$, k has it maximum value then from equation (5.22) and (5.23), then for $M_1 > M_2$ the roots can be given as

$$\omega_+^2 = \frac{2c}{m_2} \text{ and } \omega_-^2 = \frac{2c}{m_1}.\tag{5.24 a}$$

Now we will discuss the particle displacement in the transverse waves as (OT and AT). For optical branch, the transverse displacements atoms m_1 and m_2 can be obtained as

$$\frac{u}{v} = -\frac{M_2}{M_1} \quad (5.24 \text{ b})$$

Thus the ratios of amplitudes are inversely proportional to their masses. The TO and TA waves are depicted in figure 5.7

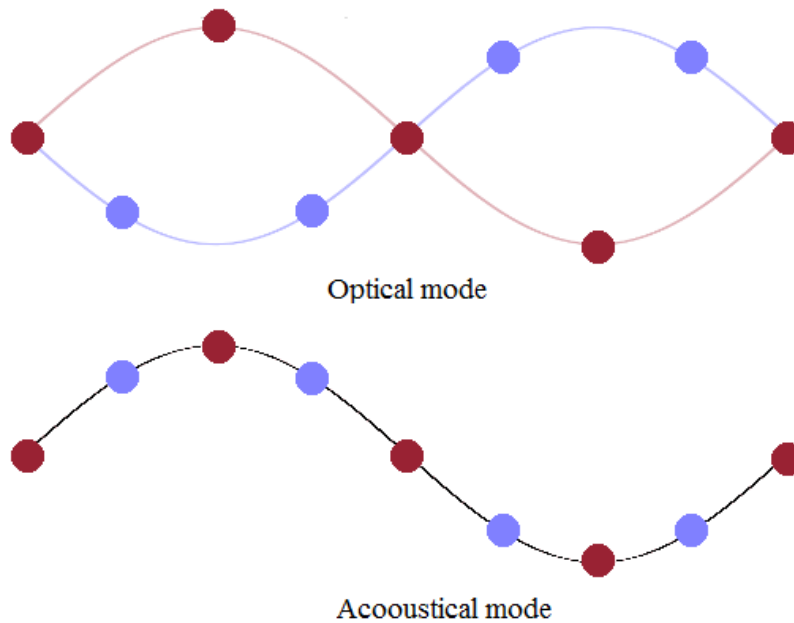

Figure 5.7. Transverse acoustical (TA) and transverse optical (TO) waves in a diatomic linear lattice

Forbidden Gaps: It can be observed from figure 5.6 that the vibrations between the frequencies $\sqrt{\frac{2C}{M_1}}$ and $\sqrt{\frac{2C}{M_2}}$ are not possible. These frequencies between these ranges are not shown in lattice vibrations and called forbidden gap. Therefore, the lattice vibrations of diatomic lattice can be considered as band stop filter. If the mass of M_1 and M_2 are same, then forbidden gap becomes zero. In this forbidden range, the two successive atoms vibrate in opposite phase with same amplitude so that they cancel the vibrations of each other, and there is no any wave in this region.

5.5 QUANTISATION of ELASTIC WAVES

The energy associated with lattice vibration is quantised. The quanta of lattice vibration are called phonons. This is similar to quantisation of electromagnetic energy, where the quanta of electromagnetic wave is photon which is quantised as $E = nh\nu$ where n is any integer number, ν

is frequency and h is Planck constant. In case of lattice, thermal vibrations are always available which are responsible for lattice vibration. This is analogous to excitation of photon in a cavity of black body. The energy associated to lattice vibrations or elastic wave can be given as

$$\epsilon = \left(n + \frac{1}{2}\right) \hbar\omega \quad (5.25)$$

where ω is angular frequency and \hbar Planck constant and n is any integer number.

The term corresponding to $n = 0$ i.e.

$$\epsilon = \frac{1}{2} \hbar\omega \quad (5.26)$$

This is called zero point energy. This energy is equivalent to quantum harmonic Oscillator. Zero point energy is lowest possible energy that a quantum mechanical system may have. Zero point energy of a system is arising due to quantum fluctuations which are always available in the system even as zero temperature. The phonons play a significant role to explain in any Physical system like thermal conductivity, electric conductivity, bulk modulus, magnetic properties of solids.

5.5.1 Phonon Momentum

Phonon is basically quanta of lattice vibrations. Phonon exists only during the lattice vibrations and physically it does not exist. Therefore a lattice phonon does not carry any momentum but phonon interacts with other particle or fields such as photon, electron, neutrons etc. as it has a momentum $\hbar k$. where k is wave vector. However, a photon has no physical mass but it interacts with other particle as it has momentum $p = \hbar k$. p is also called crystal momentum.

According to de' Broglie relation

$$p = \frac{h}{\lambda} = \hbar k \quad (5.27)$$

The physical significance of $\hbar k$ is conservation of linear momentum in a crystal.

According to Bragg's diffraction law in crystal

$$k' = k + G \quad (5.28)$$

Where G is reciprocal lattice vector, k is incident wave vector, k' is scattered wave vector. The above equation shows the conservation of momentum in reciprocal lattice system. If the scattering of phonon is inelastic, which create a phonon of wave vector K , then the wave vector conservation relation becomes

$$k' + K = k + G \quad (5.29)$$

In term of momentum the conservation relation becomes

$$\hbar k' + \hbar K = \hbar k + \hbar G \quad (5.30)$$

Similarly in term of energy the conservation relation becomes

$$\hbar \omega' + \hbar \omega = \hbar \omega + \hbar \omega_G \quad (5.31)$$

If a phonon K is absorbed in the process, we have relation

$$k' - K = k + G$$

5.6. INELASTIC SCATTERING by PHONON

When neutron strikes on a crystal lattice, it interacts with lattice vibrations of crystal and shows inelastic scattering. In inelastic scattering, the neutron transfers energy to lattice in the form of emission or absorption of phonons. The phonon dispersion relation $\omega(k)$ can be determined with the help of inelastic scattering of neutron. Further, with the help of angular width of scattering of neutron, the lifetime of phonon can be obtained.

The relation for the interaction of neutron with lattice vibration can be given as

$$k' \pm K = k + G$$

Where $\pm K$ is the wave vector of phonon created or absorbed during the interaction. k is incident wave vector, k' is scattered wave vector and G is any reciprocal lattice vector. If m_n is mass of neutron, then the kinetic energy of incident neutron is $\frac{p^2}{2m_n}$ and momentum of neutron is $\hbar k$.

$$\text{Thus the kinetic energy of incident neutron} = \frac{\hbar^2 k^2}{2m_n}$$

$$\text{The kinetic energy of scattered neutron} = \frac{\hbar^2 k'^2}{2m_n}$$

$$\text{The total energy can be given as} \quad \frac{\hbar^2 k^2}{2m_n} = \frac{\hbar^2 k'^2}{2m_n} \pm \hbar k$$

5.7 SUMMARY

1. The wave associated with crystal vibrations is called elastic wave or lattice wave.
2. The energy associated with lattice vibrations is quantised like electromagnetic wave, charge etc. The quantum unit (quanta) of lattice vibration is called phonon.

3. The energy associated to lattice vibrations or elastic wave can be given us

$$\epsilon = \left(n + \frac{1}{2}\right) \hbar\omega$$

The energy corresponding to $n = 0$; $\epsilon = \frac{1}{2} \hbar\omega$ is called zero point energy. Zero point energy is lowest possible energy that a quantum mechanical system may have.

4. When a neutron is scattered inelastically, a phonon of wave vector \mathbf{K} is created or absorbed during the interaction of neutron and lattice vibrations. If the incident wave vector of neutron is \mathbf{k} and scattered wave vector is \mathbf{k}' then $\mathbf{k}' \pm \mathbf{K} = \mathbf{k} + \mathbf{G}$ where \mathbf{G} is a reciprocal lattice vector.

5.8: GLOSSARY

Elastic wave: The wave associated with crystal vibrations is called elastic wave.

Phonon: The energy associated with the lattice vibration is also quantized like electromagnetic energy, charge etc. The quanta of lattice vibrations or elastic wave are called phonon.

Lattice vibration: all the constituents of crystal lattice are vibrating regularly. There vibrations are in atomic level and called crystal vibrations or lattice vibrations,

Dispersion relation: relation between ω frequency and wave vector \mathbf{k} for lattice.

Brillouin zone : In reciprocal lattice system, the boundary lies at $k = \pm \frac{\pi}{a}$ is first Brillouin zone.

Dispersive medium: A medium in which wave of different frequencies travel with different velocities.

Non dispersive medium: In this medium all the frequencies travel at same velocity.

Density of states: The number of different states at a particular energy level.

5.9 REFERENCES

1. C Kittel, Introduction to Solid State Physics 7th Edition, John Wiley and Sons, Singapore
2. H C Gupta, Solid State Physics, Vikas Publication House, New Delhi

Introduction to Solid State Physics, Arun Kumar, PHI Learning Private Limited, New Delhi

5.10 SUGGESTED READING

1. OS Pillai, Solid state *Physics*, New Age International(P) limited, New Delhi
2. Solid State Devices, B.Somanathan Nair, S.R. Deepa, PHI Learning Private Limited, New Delhi.
3. Fundamentals of Solid State Physics, B.S. Saxena, R.C. Gupta, P.N. Saxena, Pragati Prakashan Meerut.
4. Principle of the theory of lattice dynamics, H. Bottger, Weinheim physic verlag.

5.11. TERMINAL QUESTIONS

5.11.1. Long Answer type questions

- Q1. Show that in a one dimensional diatomic linear chain of atoms, both acoustic and optical branches of dispersion curve meet at zone boundary.
- Q2. Obtain dispersion relation of a monatomic chain of identical atoms.
- Q3. Derive expression for different modes of vibrations of diatomic linear chain of atoms.

5.11.2. Short answer type questions

- Q1. What are the normal modes of vibrations?
- Q2. Explain the meaning of lattice vibration.
- Q3. What are phonons? Give the properties of phonon.
- Q4. Explain the dispersion curves.
- Q5. What are Brillouin Zones?
- Q6. What are group velocity and phase velocity? Obtain the relation between group and phase velocities.
- Q7. What is zero point energy of a quantum mechanical system?
- Q8. Explain the neutron inelastic scattering by crystal lattice.

UNIT 6**THERMAL PROPERTIES of
SOLIDS**

Structure

- 6.1 Introduction
- 6.2 Objective
- 6.3 Classical theory of heat capacity of solids
- 6.4 Plank distribution function
- 6.5 Einstein Theory of heat capacity
- 6.6 Density of state
 - 6.6.1 Density of state in one dimension
 - 6.6.2 Density of state in three dimensions
- 6.7 Debye theory of heat capacity
- 6.8 Anharmonic Crystal Interactions
- 6.9 Thermal Expansion
- 6.10 Gruneisen Parameter and Equation of State:
- 6.11 Thermal Conductivity
 - 6.11.1 Lattice Thermal Conductivity
 - 6.11.2 Electronic Thermal Conductivity
- 6.12 Normal and Umklapp Processes
- 6.13 Imperfection
- 6.14 Summary
- 6.15 Glossary.
- 6.16 References
- 6.17 Suggested reading
- 6.18 Terminal questions

6.1 INTRODUCTION

The heat capacity is defined as amount of heat required to change the temperature of a substance by 1°C. The specific heat capacity or specific heat is the heat capacity of unit mass (one gram of the substance). Heat capacity or thermal capacity is a physical property of a material. In this unit we will discuss the heat capacity in terms of a phonon gas and effect of anharmonic lattice interaction on the heat capacity.

Specific heat of substance is defined as

$$c = \frac{dQ}{m.dT} \quad (6.1)$$

According to first law of thermodynamics, the heat supplied to a substance is utilised in raising the temperature or internal energy and secondly in some work done by system to change its volume as

$$dQ = dU + pdV \quad (6.2)$$

Where the symbols have their usual meaning. Commonly heat capacities are two types. If the system is at constant volume, then heat capacity becomes

$$C_V = \left(\frac{\partial Q}{\partial T}\right)_V = \left(\frac{\partial U}{\partial T}\right)_V \quad (6.3)$$

Similarly, the heat capacity at constant pressure is define as

$$C_p = \left(\frac{dQ}{dT}\right)_p \quad (6.4)$$

In gases there is a significant difference between C_p and C_V . However, in solids, there is a very small change in volume with pressure therefore, C_p is almost same as C_V and generally called specific heat of solid, usually it means the heat capacity at constant volume. In solids, when heat is supplied, the atoms of molecules start vibration about its equilibrium position. These vibrations are responsible for different thermal properties of solids.

6.2 OBJECTIVE

After reading this unit you will be able to understand

- * Heat capacity, specific heat capacity of solids
- * Lattice heat capacity and electronic heat capacity of solids
- * Classical theory of heat capacity
- * Einstein and Debey theory of heat capacity
- * Thermal Expansion
- * Thermal Conductivity

6.3 CLASSICAL THEORY of HEAT CAPACITIES

A crystal is an arrangement of atoms or molecules in a regular manner. These atoms are bonded by strong binding force but each atom can vibrate about its equilibrium position and comminute as three-dimensional harmonic oscillator. When the solid is heated, its internal energy increases and the atoms vibrate more strongly. Thus according to chemical theory of heat capacity, it is assumed that each atoms in a solid act as three dimensional harmonic oscillators. If heat energy is supplied to the solid, the vibrational energy of solid increases. If the system has N number of atom or independent harmonic oscillator, then there are 3N independent one dimensional harmonic oscillator as each atom has 3 degree of freedom. According to classic equipartition theorem, each degree of freedom contributes kT energy to internal (Vibrational) energy of solid.

The total vibrational energy of solid containing N number of atom or 3N number of one dimensional harmonic oscillator

$$E = 3N \cdot kT = 3NkT \quad (6.5)$$

$$\text{Heat capacity of solid } C_v = \left(\frac{dE}{dT} \right)_v = 3Nk = 3R \quad (6.6)$$

$$C_v = 5.96 \frac{\text{cal}}{\text{mole-K}}$$

Thus the heat capacity (at constant volume) remains same for all solids. This is the result based on classical theory of heat capacity and known as Dulong-Petit law. When we plot the heat capacities of different solids (say metals) it is observed that at high temperature, the heat capacity is almost $3R$ for most of solids which is a good agreement between experimental values and classical theory of heat capacity as shown in figure 6.1. But at low temperature, the classical theory of heat capacity does not hold and heat capacity decreases as temperature decreases to 0 K. This is known as the failure of classical theory of heat capacity at low temperature. The discrepancy was later on resolved by Einstein and Debye by using quantum theory.

It is also mentioned here, when heat energy is supplied to a solid, the most of heat is utilised to increase the internal energy of solid. A very small part of this energy is utilised in the excitation of free electrons available in the solid. The first contribution, which is responsible for atomic vibration or phonon is called lattice heat, which gives lattice heat capacity. The second contribution, which excite the electron called electron heat capacity. The total heat capacity can be given as

$$C_{\text{solid}} = C_{\text{lattice}} + C_{\text{electron}} \quad (6.7)$$

However, the electron's contribution on heat capacity is very small or it can be considered that no free electrons are available in a solid therefore many times only lattice heat capacity is considered.

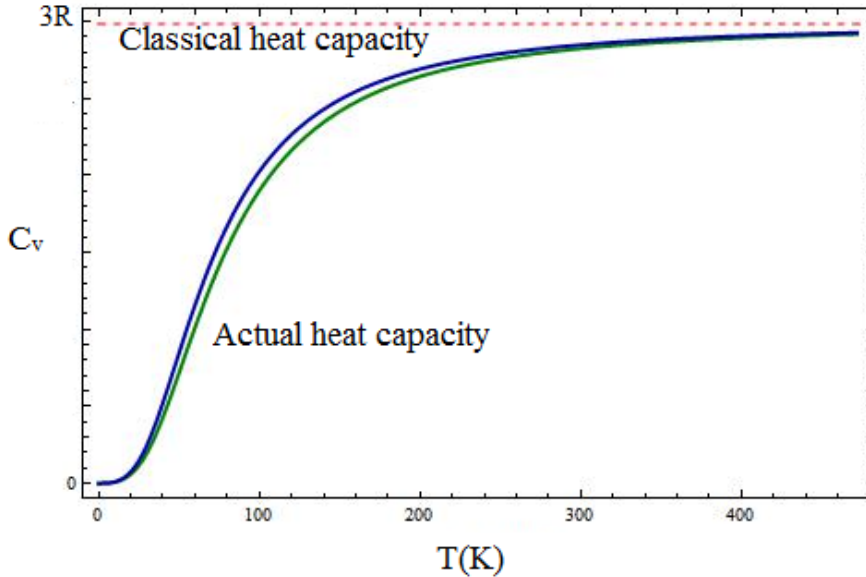

Figure 6.1: Heat capacity of solids (copper and germanium)

6.4 PLANK DISTRIBUTION FUNCTION

Let us consider a mole of solid and there are N number of atoms and each atom has three degree of freedom. Each mode of system is considered as a quantum mechanical simple harmonic oscillator. The vibration of each oscillator can be expressed by phonon. The total energy of phonons in a crystal can be given as sum of the energy of each phonon

$$\text{Energy of a phonon} = k_B T$$

The energy of all phonon modes can be given as

$$U = \sum_k \sum_p U_{kp} = \sum_k \sum_p \langle n \rangle \hbar \omega \quad (6.8)$$

Where $\langle n \rangle$ is thermal equilibrium occupancy of phonon. \sum_k and \sum_p represents sum over all wave vector and polarisation mode.

At thermal equilibrium, occupancy of phonon $\langle n \rangle$ is given by

$$\langle n \rangle = \frac{1}{\exp\left(\frac{\hbar \omega}{kT}\right) - 1} \quad (6.9)$$

This is called Plank's distribution.

6.5 EINSTEIN THEORY of HEAT CAPACITY

According to Plank theory (quantum theory), a physical system like black body, can be considered as system of simple harmonic oscillators. On the basis of Plank's quantum theory, Einstein proposed a hypothesis that a solid can be consider as a system of harmonic oscillators. The energy or thermal energy of solid can be obtained by the summing over energy of all simple harmonic oscillators. According to quantum theory of solids atoms are identical, independent harmonic oscillator, and vibrate independently with same natural frequency but have desecrate energy values. The energy of the system can be given by Planck's law given as

$$E = n\hbar\omega \quad (6.10)$$

If we consider a solid of N atoms and each atom is considered as an oscillator, and dN oscillator have energy range between E to E+dE then the Boltzmann $\langle E_n \rangle$ of system can be given by

$$\langle E_n \rangle = \frac{\sum E dN}{\sum dN} \quad (6.11)$$

From Boltzmann statistic mechanics, the number of harmonic oscillators can have energy lying between ranges E to E+dE at temperature T is proportional to $\exp\left[-\frac{E}{kT}\right]$ where k is Boltzmann constant. Thus average energy of the system can be given as

$$\langle E_n \rangle = \frac{\sum_{n=0}^{n=\infty} E \exp\left[-\frac{E}{kT}\right]}{\sum_{n=0}^{n=\infty} \exp\left[-\frac{E}{kT}\right]}$$

$$\langle E_n \rangle = \frac{\sum_{n=0}^{n=\infty} n \hbar\omega \exp\left[-\frac{n\hbar\omega}{kT}\right]}{\sum_{n=0}^{n=\infty} \exp\left[-\frac{\hbar\omega}{kT}\right]}$$

Let $-\frac{\hbar\omega}{kT} = x$ then

$$\langle E_n \rangle = \frac{\hbar\omega \sum_{n=0}^{n=\infty} n e^{-nx}}{\sum_{n=0}^{n=\infty} e^{-nx}}$$

Putting the values of all n, from $n = 0$ to $n = \infty$ terms

$$\langle E_n \rangle = \frac{\hbar\omega [e^x + 2e^{2x} + 3e^{3x} + \dots \infty]}{[1 + e^x + e^{2x} + e^{3x} + \dots \infty]}$$

Using mathematical identities

$$\langle E_n \rangle = \hbar\omega \left[\frac{d}{dx} \log(1 + e^x + e^{2x} + e^{3x} + \dots \infty) \right]$$

$$\begin{aligned}
\langle E_n \rangle &= \hbar\omega \left[\frac{d}{dx} \log \left(\frac{1}{1 - e^x} \right) \right] \\
\langle E_n \rangle &= \hbar\omega \left[\frac{-e^x}{1 - e^x} \right] \\
\langle E_n \rangle &= \hbar\omega \left[\frac{e^x}{e^x - 1} \right] \\
\langle E_n \rangle &= \hbar\omega \left[\frac{1}{e^{-x} - 1} \right] \\
\langle E_n \rangle &= \frac{\hbar\omega}{e^{\hbar\omega/kT} - 1} \tag{6.12}
\end{aligned}$$

According to quantum theory of solids, the energy of a system of harmonic oscillators is given as

$$\epsilon = \left(n + \frac{1}{2} \right) \hbar\omega = \frac{1}{2} \hbar\omega + n \hbar\omega$$

Then above equation 6.12 can be modified as

$$\langle E_n \rangle = \frac{1}{2} \hbar\omega + \frac{\hbar\omega}{e^{\hbar\omega/kT} - 1} \tag{6.13}$$

The first term is zero point energy of system and secondary term is the contribution due to thermal energy. In second term, $\frac{1}{e^{\hbar\omega/kT} - 1}$ is nothing but Plank's distribution function. With the help of Plank's distribution function the thermal energy of the system can be given as

$$U = 3N \langle E_n \rangle = \frac{3N\hbar\omega}{e^{\hbar\omega/kT} - 1} \tag{6.14 a}$$

Where N is total number of atoms in solid. Einstein considered a solid of N atoms behaves as 3N independent oscillators as each atom has 3 degree of freedom.

Specific heat of system can be given as

$$\begin{aligned}
C_v &= \frac{\partial U}{\partial T} = 3N\hbar\omega \frac{1}{(e^{\hbar\omega/kT} - 1)^2} \cdot e^{\hbar\omega/kT} \cdot \hbar\omega/kT^2 \\
C_v &= 3Nk \left(\frac{\hbar\omega}{kT} \right)^2 \cdot \frac{e^{\hbar\omega/kT}}{(e^{\hbar\omega/kT} - 1)^2} \tag{6.14 b}
\end{aligned}$$

If number of atoms in solid system is one mole ($N=N_A$) atoms then $Nk = R$

$$C_v = 3R \left(\frac{\hbar\omega}{kT} \right)^2 \cdot \frac{e^{\hbar\omega/kT}}{(e^{\hbar\omega/kT} - 1)^2} \tag{6.15}$$

This is Einstein formula for specific heat of solids. If we use a term $\frac{\hbar\omega}{k} = \theta_E$ called Einstein Temperature then equation becomes

$$C_v = 3R \left(\frac{\theta_E}{T}\right)^2 \cdot \frac{e^{\theta_E/T}}{(e^{\theta_E/T} - 1)^2} \quad (6.16)$$

Variation of specific heat with the temperature at different temperatures is shown as Figure 6.2.

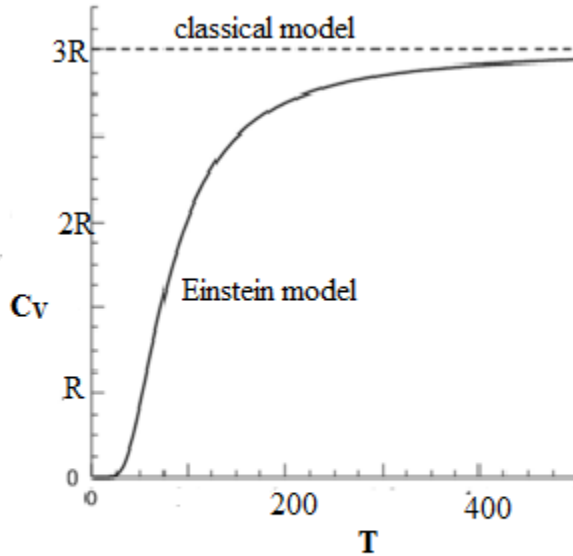

Figure 6.2: Variation of specific heat with temperature in Einstein model.

At high temperature $\theta_E \ll T$ or $\hbar\omega \ll kT$ Then energy

$$U = \frac{3N\hbar\omega}{e^{\hbar\omega/kT} - 1}$$

We know that $e^x = 1 + x + \frac{x^2}{2} + \frac{x^3}{3} + \dots$

For high value of T or small value of x we can ignore higher terms then above expression becomes

$$U = \frac{3N\hbar\omega}{1 + \frac{\hbar\omega}{kT} - 1} = 3NkT$$

$$C_v = 3NkT = 3R \quad (6.17)$$

Thus at high value of temperature, the expression reduces to classical result.

6.6 DENSITY OF STATES

If a crystal is considered as a system of simple harmonic oscillator, then the energy of crystal can be given as

$$U = \sum_k \sum_p \langle n \rangle \hbar \omega_{kp} \quad (6.18)$$

Where $\langle n \rangle$ is plank distribution function and $\hbar \omega_{kp}$ is average energy.

$$U = \sum_k \sum_p \frac{\hbar \omega_{kp}}{e^{\hbar \omega_{kp}/kT} - 1} \quad (6.19)$$

Some time we replace the summation over k , \sum_k by an integral as the crystal has $D_p(\omega)d\omega$ modes of polarisation in frequency range ω to $+d\omega$. Then the above equation of energy becomes

$$U = \sum_p \int d\omega D_p(\omega) \frac{\hbar \omega}{e^{\hbar \omega/kT} - 1} \quad (6.20)$$

The term $D(\omega)$ in the above expression (eq.6.20) is number of modes per unit frequency is called density or states density of modes. Once we calculate the density of states (ω), we can calculate the energy of system and heat capacity. This is a central problem to calculate $D(\omega)$. Practically, $D(\omega)$ is obtained by measuring the dispersion relation, ω versus k in a selected crystal direction by inelastic neutron scattering.

6.6.1 Density of State in one Dimension

Consider a one dimensional chain of $N + 1$ atom arranged in a distance a between two atoms as shown in figure 6.3. We assume that the first particle is situated at $S = 0$ and N^{th} particle at $S = N$, the ends of linear chain. We consider that the ends points are fixed. Each vibrational mode of polarisation p form a standing wave between ends (fixed) point. If us the displacement of s^{th} particle, then according to standing wave

$$u_s = u_0 e^{-i\omega_{kp}t} \cdot \sin ska \quad (6.21)$$

As we know, in one dimension linear chain, the wave number k is restricted by boundary then acceptable value of k are

$$k = \frac{\pi}{L}, \frac{2\pi}{L}, \frac{3\pi}{L} \dots \frac{(N-1)\pi}{L} \quad (6.22)$$

and wave vanishes as $k = 0$ and $k = \frac{N\pi}{L}$

Thus eq. 6.21 becomes

$$u_s = u_0 \sin ska$$

$\sin ska$ Vanishes at each atom, thus (N-1) allowed values of k are possible as given in eq.(6.22). This number is equal to the number of particles allowed to move and each allowed value of k is corresponding to a mode. Therefore in case of one dimensional line, the number of modes per unit range k is $\frac{L}{\pi}$.

The number of modes $D(\omega)d\omega$ in $d\omega$ range in one dimension can be given as

$$D(\omega)d\omega = \frac{L}{\pi} \frac{dk}{d\omega} d\omega = \frac{L}{\pi} \frac{d\omega}{\left(\frac{d\omega}{dk}\right)} \tag{6.23}$$

In above relation $\frac{d\omega}{dk}$ is group velocity and can be obtained by dispersion relation (relation between ω and k). Density of state $D(\omega)$ can not be defined at a point $\frac{d\omega}{dk} = 0$ where $\omega(k)$ becomes horizontal or group velocity becomes zero. This point is called singularity.

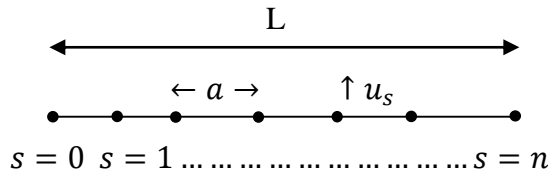

Figure 6.3 One dimensional chain of atoms

6.6.2: Density of State in Three Dimensions

Consider a cubic primitive cell of side length L. If there are N numbers of atoms in one dimension then N^3 atom in 3 dimensions, and we have N^3 primitive cell. If k is wave vector in reciprocal lattice system then boundary condition may be applied over N^3 primitive cells and k can be determined by the boundary conditions for lattice vibrations allowed in the crystal lattice. As we know boundary condition is

$$e^{i[k_x x + k_y y + k_z z]} = e^{i[k_x(x+L) + k_y(y+L) + k_z(z+L)]}$$

which gives

$$k_x, k_y, k_z = 0; \pm \frac{2\pi}{L}, \pm \frac{4\pi}{L}; \dots \frac{N\pi}{L} \tag{6.24}$$

Therefore there is one allowed value of k (mode) per unit volume of $\left(\frac{2\pi}{L}\right)^3$ in reciprocal space. The total number of modes can be obtained by divide the volume of a sphere of k in reciprocal lattice system by volume of $\left(\frac{2\pi}{L}\right)^3$ corresponding to one mode.

Then total number of modes = $\frac{\text{Volme of sphere in k space}}{\text{Unit volume corresponding to one mode}}$

$$N = \frac{\frac{4}{3}\pi k^3}{\left(\frac{2\pi}{L}\right)^3}$$

$$N = \left(\frac{L}{2\pi}\right)^3 \cdot \frac{4}{3}\pi k^3 \quad (6.25)$$

For each polarisation mode. The density of state $D(\omega)$ can be calculated as

$$D(\omega) = \frac{dN}{d\omega} = \frac{L^3}{2\pi^2} k^2 \frac{dk}{d\omega} \quad (6.26)$$

$$D(\omega) = \frac{Vk^2}{2\pi^2} \frac{dk}{d\omega} \quad (6.27)$$

6.7. DEBYE THEORY OF HEAT CAPACITY

Einstein model was based on the assumption that atoms of crystals vibrate independently to one other. The vibration of crystal as a whole was considered to be the same as the vibration of each atom. The common angular frequency of vibration was considered as ω , which natural frequency of vibration. But Debye assumed that the atoms of crystal form coupled harmonic oscillators and there are a range of frequencies rather than a single frequency. Debye proposed that the frequency may have values from the low range (sound wave) to high frequency of optical wave. These modes of vibrations, per unit frequency range are nothing but density of state.

In Debye approximation, the velocity of sound is constant in crystal which is lower limit of vibration, so we need to innumerate number of sound modes that exist in the crystal. The angular frequency ω of vibration can be given as

$$\omega = vk \quad (6.28)$$

Where v is velocity of sound wave.

From equation 6.27, Density of state can be given as

$$D(\omega) = \frac{dN}{d\omega} = \frac{Vk^2}{2\pi^2} \frac{dk}{d\omega}$$

$$D(\omega) = \frac{V(\omega/v)^2}{2\pi^2} \frac{d}{d\omega} \left(\frac{\omega}{v}\right) = \frac{V\omega^2}{2\pi^2 v^3} \quad (6.29)$$

If there are N numbers of primitive cell in the crystal, L is side length and V is volume, then total number of acoustic phonon modes are $3N$. The cut of frequency ω_D can be given by

$$\omega_D = v k_D$$

by using eq. (6.25)

$$N = \left(\frac{L}{2\pi}\right)^3 \cdot \frac{4}{3} \pi k^3$$

$$N = \frac{V}{8\pi^3} \cdot \frac{4}{3} \pi \cdot \left(\frac{\omega_D}{v}\right)^3 = \frac{V}{6\pi^2} \cdot \frac{\omega_D^3}{v^3}$$

$$\omega_D^3 = \frac{6\pi^2 N v^3}{V} \quad (6.30)$$

This frequency is corresponding to cutoff wave function. The cut of wave vector k_D can be given as

$$k_D = \frac{\omega_D}{v} = \left(\frac{6\pi^2 N}{V}\right)^{\frac{1}{3}} \quad (6.31)$$

This wave vector is corresponding to sound wave which is lowest limit of vibration. In this model we do not consider wave vector larger the cut off wave vector k_D .

The thermal energy of the crystal is given as

$$U = \int D(\omega) \cdot n(\omega) \cdot \hbar\omega \cdot d\omega \quad (6.32)$$

$$U = \int_0^{\omega_D} \left(\frac{V\omega^2}{2\pi^2 v^3}\right) \cdot \left(\frac{\hbar\omega}{\exp\left(\frac{\hbar\omega}{k_B T}\right) - 1}\right) d\omega \quad (6.33)$$

Where $n(\omega)$ is Plank distribution fraction as given in eq.(6.9) and $D(\omega)$ is Density of state as given is eq. 6.29. If we assume that phonon velocity is independent of polarisation, so that we introduce a multiplication factor 3 to obtain thermal energy.

$$U = \left(\frac{3V\hbar}{2\pi^2 v^3}\right) \int_0^{\omega_D} \left(\frac{\omega^3}{\exp\left(\frac{\hbar\omega}{k_B T}\right) - 1}\right) d\omega \quad (6.34)$$

If we consider $\frac{\hbar\omega}{k_B T} = x_D = \theta/T$ for solving the integration then

$$U = \left(\frac{3V\hbar k_B^4 T^4}{2\pi^2 v^3 \hbar^3}\right) \int_0^{x_D} \left(\frac{x^3}{e^x - 1}\right) dx \quad (6.35)$$

$$U = 9 N k_B T \left(\frac{T}{\theta_D} \right)^3 \int_0^{x_D} \frac{x^3}{e^x - 1} dx \quad (6.36)$$

$$\text{where } \theta_D = \frac{\hbar v}{k_B} \left(\frac{6 \Pi^2 N}{v} \right)^{\frac{1}{3}} \quad (6.37)$$

The θ_D given in eq. 37 is defined as is Debye temperature.

The heat capacity of solid specimen can be obtained as $c_V = \frac{dU}{dT}$ then differentiating eq. (6.35 and 6.36)

$$C_V = \left(\frac{3V\hbar}{2\Pi^2 v^3} \right) \int_0^{\omega_D} \frac{\omega^4 e^{\frac{\hbar\omega}{k_B T}}}{\left(e^{\frac{\hbar\omega}{k_B T}} - 1 \right)^2} d\omega \quad (6.38)$$

$$\text{and } C_V = 9Nk_B \left(\frac{T}{\theta_D} \right)^3 \int_0^{x_D} \frac{x^4 e^x}{(e^x - 1)^2} dx \quad (6.39)$$

Where $\frac{\hbar\omega}{k_B T} = x$ and θ_D is Debye Temperature define as $\theta_D = \frac{\hbar\omega_D}{k}$

This is shown in figure 6.4. At higher temperature $T > \theta_D$, x becomes very small and expanding the exponential in equation 6.39, the integral becomes almost x^2 so that the heat capacity approaches

$$C_V = 9Nk_B \left(\frac{T}{\theta_D} \right)^3 \int_0^{\theta/T} x^2 dx = 9Nk_B \left(\frac{T}{\theta_D} \right)^3 \cdot \left[\frac{x^3}{3} \right]_0^{\theta/T} = 3Nk_B = 3R$$

This is classical value $3Nk_B$.

At low temperature $T \ll \theta_D$, we can consider integral limit $x_D \rightarrow \infty$ then

$$\int_0^{\infty} \frac{x^4 e^x}{(e^x - 1)^2} dx = \frac{4\Pi^4}{15} \quad (6.40)$$

Putting this value in eq. 6.39, it becomes

$$C_V = 9Nk_B \left(\frac{T}{\theta_D} \right)^3 \frac{4\Pi^4}{15} = 12Nk_B \frac{\Pi^4}{5} \left(\frac{T}{\theta_D} \right)^3$$

$$c_v = 234 N k_B \left(\frac{T}{\theta_D} \right)^3 \quad (6.41)$$

This is known as Debye T^3 law of heat capacity of solids.

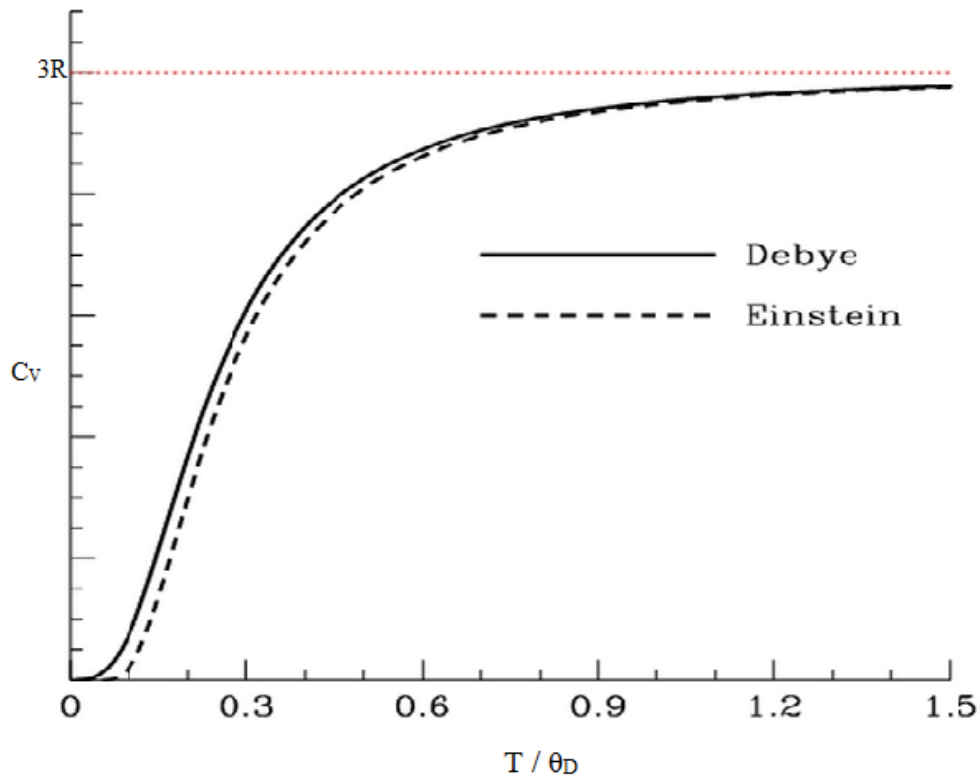

Figure 6.4: Heat capacity of solids according to Debye model

6.8 ANHARMONIC CRYSTAL INTERACTIONS

We have studied the theory of lattice vibration on the assumption that the crystal is ideal. The harmonic theory used in the lattice vibrations of solids assumes that the anharmonic terms in the lattice potential energy expansion are neglected while the quadratic term is retained. However, in actual case the anharmonic terms are also significance.

In case of idea crystal, the consequences of lattice vibration are:

1. The lattice waves do not interact.
2. The lattice waves do not decay during propagation in the crystal.
3. There is no thermal expansion during the lattice wave propagation.
4. The heat capacity becomes constant at high temperature as Debye law.

But the real, crystal is not as ideal and these consequences are not satisfied exactly. The deviations are attributed to enharmonic crystal interaction. The enharmonic interaction is basically arising due to higher terms in the interatomic displacement. The effect of anharmonic interaction

in crystal is very significant and gives different result as thermal expansion, thermal conductivity, resistance etc.

6.9 THERMAL EXPANSION

Thermal expansion of a solid is change in size of a solid due to change in temperature. If the lattice vibrations are perfectly harmonic then interatomic vibrations follow Hook's law exactly, and there is no change in the dimension of solid on raising the temperature of solid. However, in actual, the vibrations are not perfectly harmonic and dimensional changes occurs during the change of temperature. Thermal expansion of solid is a consequence of displacement of ions or atoms of the material as temperature changes. The thermal expansion of solid is characterized by volume thermal expansion coefficient & which is defined as change in volume per unit volume per unit temperature rise as given below.

$$\alpha_V = \frac{1}{V} \frac{dV}{dT} \quad (6.42)$$

We can also define linear coefficient which is

$$\alpha_L = \frac{1}{L} \frac{dL}{dT} \quad (6.43)$$

We can also know that linear coefficient is 1/3rd of volume thermal expansion and defined as change in length per unit length, per unit change in temperature. As we discussed if the lattice vibration in a solid were perfectly harmonic, then the atoms or molecules of solid obey Hook's law exactly and there would be no dimensional change on raising the temperature of solid. But in actual, the lattice vibrations are not perfectly harmonic and this anharmonicity in solid leads to the concept of thermal expansion. The anharmonicity can be understand by the potential energy curve against interatomic distance as shown in figure 6.5.

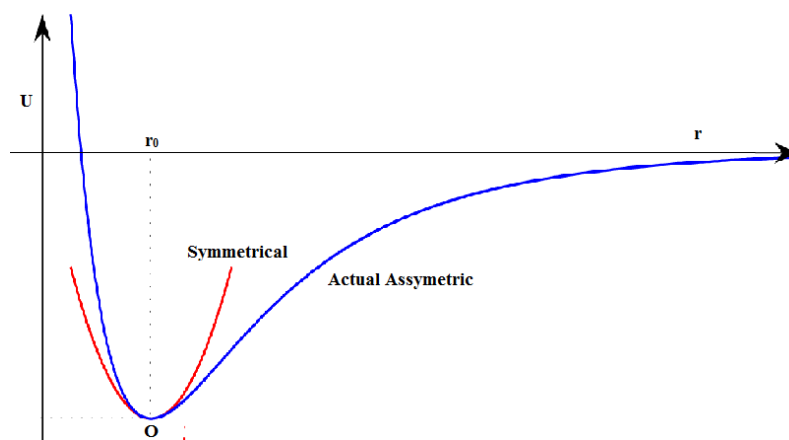

Figure 6.5 Asymmetry potential energy curve

Point O is minimum energy point or equilibrium point where the inter atomic spacing is r_0 . As temperature rise, the energy of system also increases. The interatomic spacing remains same if potential energy curve were symmetrical on both side of point O. But in actual the curve on both side of dotted is not symmetrical as gradient on both sides is different. The difference in symmetry in potential energy curve means the anharmonicity in lattice vibration which provide the basis for origin of thermal expansion.

Therefore, we take the potential energy of atoms of a solid with a displacement x from its their equilibrium position at absolute zero temperature as

$$U(x) = cx^2 - gx^3 - fx^4 \quad (6.44)$$

Where c is a constant corresponding to Hook's law and g and f are other higher term constants corresponding to asymmetry arises due to mutual repulsion of atoms and f is another constant associated with x^4 which represents the softening of vibration at large amplitude.

As $x = 0$; is not an absolute zero, potential energy for small oscillation can be written as

$$U(x) = U_0(x) + cx^2 + gx^3 - fx^4 \quad (6.45)$$

The force can be given as

$$F = -\frac{\partial U}{\partial x} = -\beta x + gx^2 - f'x^3 \quad (6.46)$$

This is Hook's law with higher order terms. By using thermodynamic probability, we can find out the value of average displacement $\langle x \rangle$ with the help of Boltzmann distribution function as

$$\langle x \rangle = \frac{\int_{-\infty}^{\infty} x e^{-U(x)/k_B T} dx}{\int_{-\infty}^{\infty} e^{-U(x)/k_B T} dx} \quad (6.47)$$

The numerator and denominator of above expression is a standard integration in mathematics and its value is

$$\int_{-\infty}^{\infty} x e^{-U(x)/k_B T} dx = \frac{3g}{4k_B T} \sqrt{\left(\frac{\pi}{c/k_B T}\right)^5} \quad (6.48)$$

$$\text{and} \quad \int_{-\infty}^{\infty} e^{-U(x)/k_B T} dx = \sqrt{\left(\frac{\pi}{c/k_B T}\right)} + \frac{3}{4} \frac{f}{k_B T} \sqrt{\frac{\pi}{\left(\frac{c}{k_B T}\right)^5}} \quad (6.49)$$

Using above expansions

$$\langle x \rangle = \frac{3g k_B T}{1 + 3f \frac{k_B T}{4c^2}} = \frac{3g k_B T}{4c^2} \left(1 + 3 \frac{f k_B T}{4c^2}\right)^{-1}$$

This is a binomial and using first order approximation

$$\langle x \rangle = \frac{3g k_B T}{4c^2} \left(1 + 3 \frac{f k_B T}{4c^2}\right)$$

Ignoring 2nd term as its value is negligible in with respect to first term

$$\langle x \rangle = \frac{3g}{4c^2} k_B T \quad (6.50)$$

Coefficient of linear Thermal expansion can be given as

$$\alpha = \frac{1}{r_0} \frac{d\langle x \rangle}{dT} = \frac{3g}{r_0 4c^2} k_B \quad (6.51)$$

Thus according to classical statistic the $\langle x \rangle$ is proportional to temperature but thermal expansion coefficient α is independent to T. At normal room temperature, this result is valid but when temperature goes to absolute zero temperature, the value of α tends to zero. To understand this fact, we use quantum mechanics. Replacing the classical statistics, quantum mechanics (replace $k_B T$ by $\frac{\hbar\omega}{e^{\frac{\hbar\omega}{k_B T}} - 1}$), $\langle x \rangle$ can be given as

we in equation then we have

$$\langle x \rangle = \frac{3g}{4c^2} \frac{\hbar\omega}{e^{\frac{\hbar\omega}{k_B T}} - 1} \quad (6.52)$$

At high temperature $T \rightarrow \infty$ it becomes $\langle x \rangle = \frac{3g}{4c^2} k_B T$ it assumes the classical limit.

But at low temperature $T \rightarrow 0$ then $\langle x \rangle = \frac{3g}{4c^2} \hbar\omega e^{-\frac{\hbar\omega}{k_B T}}$

And thermal expansion
$$\alpha = \frac{1}{r_0} \frac{d\langle x \rangle}{dT} = \frac{1}{r_0} \frac{3g}{4c^2} \left(\frac{\hbar\omega}{k_B T}\right)^2 k_B e^{-\frac{\hbar\omega}{k_B T}} \quad (6.53)$$

From this equation it is clear that as $T \rightarrow 0$ the α also goes to zero as observed in experimental results.

6.10 GRUNEISEN PARAMETER AND EQUATION OF STAT

Gruneisen parameter is measurement of anharmonicity of a crystal and denoted by γ . Gruneisen assumed that the lattice vibrational frequency ω varies inversely as γ^{th} power of volume.

$$\begin{aligned}
\text{Mathematically} \quad \omega &\propto \frac{1}{V^\gamma} \quad \text{or} \quad \omega = \frac{C}{V^\gamma} \\
\text{Taking natural log} \quad \ln \omega &= \ln C - \gamma \ln V \\
\text{on differentiating} \quad \frac{1}{\omega} d\omega &= \frac{-\gamma}{V} dV \\
\gamma &= \frac{V}{\omega} \frac{d\omega}{dV} \tag{6.54}
\end{aligned}$$

Gruneisen observed that the ratio of thermal expansion coefficient to the specific heat is constant for a given crystal at all temperature.

$$\begin{aligned}
\text{Mathematically} \quad \frac{C}{C_V} &= \frac{1}{3V} \frac{\gamma}{B} \\
\alpha &= \frac{1}{3V} \gamma \frac{C_V}{B} \tag{6.55}
\end{aligned}$$

where B is bulk modulus. The typical value of Gruneisen parameter γ is order of 2.

6.11 THERMAL CONDUCTIVITY

Debye extended his theory of heat capacity of solids to explain the lattice thermal conductivity of solid and observed that the thermal conductivity would be infinite if the lattice vibrations become perfectly harmonic. But the nature of lattice vibrations in real crystal is inharmonic which destroy the independence of normal modes and change the direction of propagation and different interactions take place in the crystal. Due to this inharmonicity, the thermal conductivity has a finite value.

If thermal heat energy is transmitted through a solid rod, then flux of thermal energy j_u can be give as

$$j_u = -K \frac{dT}{dx} \tag{6.56}$$

Where K is coefficient of thermal conductivity, $\frac{dT}{dx}$ is the temperature gradient at steady state flow. Thermal flux is nothing but energy transmitted per unit time across per unit volume. The process of thermal energy transfer is a random process and heat transmitted as diffused manner. In solids, the thermal conduction takes place by two process i.e. conductivity due to free elements and coefficient of free electron thermal conductivity is denoted by K_{el} , and the conductivity due to phonon or lattice vibrations is lattice thermal conductivity K_{lat} .

$$K = K_{el} + K_{lat} \tag{6.57}$$

6.11.1 Lattice Thermal Conductivity

The lattice of a solid can be considered as the form the kinetic theory of gases we can understand the thermal conductivity. Suppose a crystal lattice is like a phonon gas system. In this system of phonon on gas suppose there are N photons moving between two surfaces of a crystal (or plates) at temperature T_1 and T_2 . The two surfaces are at distance λ which is mean free path for photon gas. The photons move rand only in the system with mean velocity v .

If N phonons are randomly moving in the crystal, then $\frac{N}{3}$ phonons are moving in a particular axis and $\frac{N}{6}$ phonons move in the direction of +ve of -ve axis (say along + x or -x axis). If v is the average particle velocity and λ is mean free path then we can applied Debye theory of heat capacity for calculating the thermal conductivity.

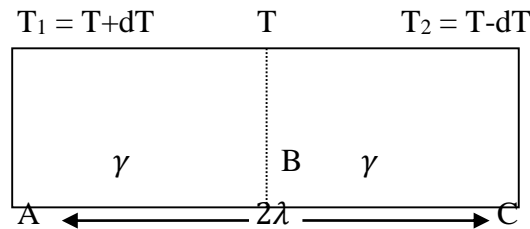

Figure 6.6: Thermal conductivity in a crystal solid

The number of phonons moving across the unit area in a second is given as

$$= \frac{Nv}{6} \quad (6.58)$$

The energy of phonon = $\frac{3}{2} k_B T$

The thermal energy passing through surface A to surface B in unit time, across unit area, can be given as

$$Q_1 = \frac{Nv}{6} \cdot \frac{3}{2} k_B (T + dT - T) = \frac{Nv}{6} \cdot \frac{3}{2} k_B dT \quad (6.59)$$

Similarly, the thermal energy passing through unit surface area, in a unit time from surface B to C is

$$Q_2 = \frac{-Nv}{6} \cdot \frac{3}{2} k_B dT \quad (6.60)$$

Thus thermal current at surface B per unit area, per unit time is

$$Q_j = Q_2 - Q_1 = \frac{Nv}{2} k_B dT \quad (6.61)$$

If thermal gradient is $\frac{dT}{d\lambda} = \frac{dT}{dx}$, then from the definition of thermal current

$$Q_j = -K \frac{dT}{d\lambda} \quad (6.62)$$

putting the value of Q_j in this eq. 6.61

$$\begin{aligned} \frac{Nvk_B}{2} dT &= K \frac{dT}{d\lambda} \\ K &= \frac{Nvk_B\lambda}{2} \end{aligned} \quad (6.63)$$

In case of solid crystal lattice heat capacity

$$C_V = \frac{3}{2} Nk_B \quad (6.64)$$

Putting this value in eq. 6.63 we will get

$$K = \frac{1}{3} C_V v \lambda$$

As this is a mode of conductivity through lattice therefore denoted as

$$K_{lattice} = \frac{1}{3} C_V v \lambda \quad (6.65)$$

6.11.2 Electronic Thermal Conductivity

In many crystalline solids there are some free electrons. In case of metals, a large number of free electrons are available and called electron gas. The contribution to thermal conductivity due to free electrons is known as electronic thermal conductivity. In case of metals electronic thermal conductivity is significant. In metals, free electrons are at Fermi surface, and then velocities of Fermi electrons are u_f , then electronic thermal conductivity is given as

$$K_{el} = \frac{1}{3} c_v u_f \lambda_f \quad (6.66)$$

Debye observed that the thermal conductivity is a result of lattice vibrations and if the lattice vibrations are perfectly harmonic, then thermal conductivity becomes infinity. But in actual the vibrations are not harmonic therefore there is a certain value of thermal conductivity. The nature of lattice vibration in real crystal is anharmonic which destroys the independent vibration modes and different modes interact each other and exchange energy. Therefore, the thermal conductivity is the result of anharmonicity of crystal.

6.12. THERMAL RESISTIVITY of PHONON GAS (Normal and Umklapp Processes)

To explain thermal conductivity, there exist mechanisms in the crystal whereby the distribution of phonon may be brought locally into thermal equilibrium. This equilibrium mechanism is helpful to explain the phonon at one end of the crystal are being in thermal equilibrium at temp T_1 and the phonons at another end of crystal are in thermal equilibrium at temperature T_2 . If phonons collide with lattice imperfection and with lattice boundaries, they do not establish thermal equilibrium because in such collision there is no change in energy of phonons. In such process where momentum and energy both remains conserved are called normal process. In such three phonon process

$$K_1 + K_2 = K_3 \text{ with } \omega_1 + \omega_2 = \omega_3 \tag{6.67}$$

Where K is phonon wave vector and ω_1 is phonon frequency. Therefore, the normal processes do not change in direction of energy flow and hence do not contribute towards the lattice thermal conductivity. The flow of phonon is shown in figure 6.7

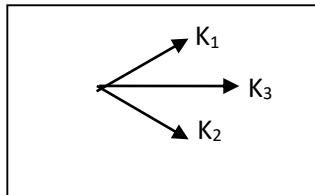

Figure 6.7(a): N-Process

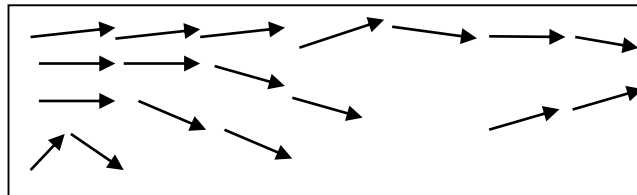

Figure 6.7(b): Net flow of phonon in N Process

6.12.1. Umklapp Process

According to perfectly harmonic vibrations in crystal, normal process occurs consequently crystal have infinite thermal conductivity. Therefore, we consider enharmonic effect. Due to enharmonic effect, there is umklapp process (U process) where the energy and moment commutation can denote it as

$$K_1 + K_2 = K_3 + G \tag{6.68}$$

where G is a reciprocal lattice vector. This process was discovered by Pearls. Such processes are always probable in the crystal lattice.

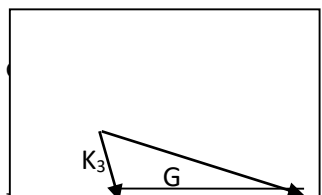

Figure 6.8 (a): U-Process

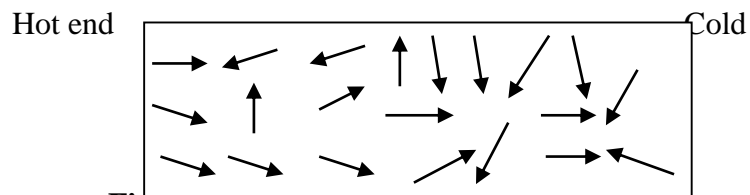

Figure 6.7 (b): Net flow phonon in U Process

Collisions corresponding to $G=0$ are called Normal process or N process. In Umklapp process, if K_1 and K_2 are larger such that the phonon wave vector $K_3 = K_1 + K_2$ is going out side, the first Brillion zone, then K_3 can bring into first Brillion zone with the help of reciprocal lattice vector G as given in eq. (6.68). The anharmonic phonon interaction, U process, is given in figure 6.8. The energy of phonons K_1, K_2 suitable for occurring U process in of order $\frac{1}{2}k_B O$. The U process also conserves energy as given in equation (6.68). The variation of thermal conductivity with temperature is shown in figure 6.9.

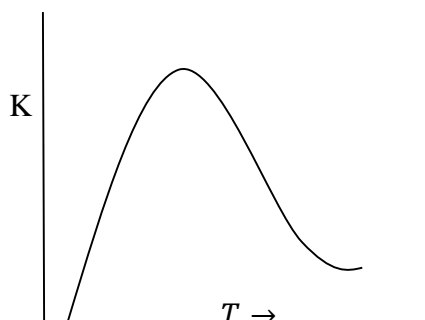

Figure 6.9: Variation of Thermal conductivity

6.13 IMPERFECTIONS

The shape and size also plays the significant role in the determination of mean free path λ . We must consider the scattering by crystal boundaries, chemical impurity, lattice imperfection and amorphous structure in the crystal. If the mean free path becomes comparable to the size of width of specimen, the value of mean free path λ is limited by width, and at low temperature thermal conductivity become the function of width of specimen. At low temperature, U process becomes ineffective and size effect become significant for the determination of thermal conductivity.

We can consider λ as constant and thermal conductivity can be given as

$$K = \frac{1}{3} C_V v D \quad (6.69)$$

where D is diameter of sample. The only temperature dependent term in above equation is specific heat C_V which is proportional to T^3 at low temperature. The variation of K at low temperature is shown in figure 6.9. For example, the thermal conductivity of Al_2O_3 (sapphire) is $200W/cm-k$ at $30^\circ K$ and for Cu (copper) thermal conducted is $100W/CmK$.

6.14 SUMMARY

1. Specific heat of solid, usually it means the heat capacity at constant volume is define as

$$C_V = \left(\frac{\partial Q}{\partial T} \right)_V = \left(\frac{\partial U}{\partial T} \right)_V$$

2. According to classical theory of heat capacity and known as Dulong-Petit law the heat capacity (at constant volume) remains same for all solids. Given as

$$C_v = \left(\frac{dE}{dT} \right)_v = 3Nk = 3R$$

3. At thermal equilibrium, occupancy of phonon $\langle n \rangle$ is called Plank's distribution and given by

$$\langle n \rangle = \frac{1}{\exp\left(\frac{\hbar\omega}{kT}\right) - 1}$$

4. Einstein formula for specific heat of solids

$$C_v = 3R \left(\frac{\hbar\omega}{kT} \right)^2 \cdot \frac{e^{\frac{\hbar\omega}{kT}}}{\left(e^{\frac{\hbar\omega}{kT}} - 1 \right)^2}$$

If we use a term $\frac{\hbar\omega}{k} = \theta_E$ called Einstein Temperature then equation becomes

$$C_v = 3R \left(\frac{\theta_E}{T} \right)^2 \cdot \frac{e^{\theta_E/T}}{\left(e^{\theta_E/T} - 1 \right)^2}$$

5. Number of modes per unit frequency is called density or states density of modes. Once we calculate the density of states (ω), we can calculate the energy of system and heat capacity.

6. The number of modes $D(\omega)d\omega$ in $d\omega$ range in one dimension can be given as

$$D(\omega)d\omega = \frac{L}{\pi} \frac{dk}{d\omega} d\omega = \frac{L}{\pi} \frac{d\omega}{\left(\frac{d\omega}{dk} \right)}$$

7. In three dimensions, the density of state $D(\omega)$ can be calculated as

$$D(\omega) = \frac{dN}{d\omega} = \frac{L^3}{2\pi^2} k^2 \frac{dk}{d\omega}$$

$$D(\omega) = \frac{vk^2}{2\pi^2} \frac{dk}{d\omega}$$

8. Debye assumed that the atoms of crystal form coupled harmonic oscillators and there are a range of frequencies rather than a single frequency. Debye proposed that the frequency may have values from the low range (sound wave) to high frequency of optical wave. These modes of vibrations, per unit frequency range are nothing but density of state. According to Debye Model

$$C_V = 9Nk_B \left(\frac{T}{\theta_D}\right)^3 \int_0^{\theta_D} \frac{x^4 e^x}{(e^x - 1)^2} dx$$

Where $\frac{\hbar\omega}{k_B T} = x$ and θ_D is Debye Temperature define as $\theta_D = \frac{\hbar\omega_D}{k}$

At higher temperature $T > \theta_D$

$$C_V = 9Nk_B \left(\frac{T}{\theta_D}\right)^3 \int_0^{\theta/T} x^2 dx = 9Nk_B \left(\frac{T}{\theta_D}\right)^3 \cdot \left[\frac{x^3}{3}\right]_0^{\theta/T} = 3Nk_B = 3R$$

At low temperature $T \ll \theta_D$

$c_v = 234 N k_B \left(\frac{T}{\theta_D}\right)^3$ This is known as Debye T^3 law of heat capacity of solids.

9. The harmonic theory used in the lattice vibrations of solids assumes that the anharmonic terms in the lattice potential energy expansion are neglected while the quadratic term is retained. However, in actual case the anharmonic terms are also significant. The effect of anharmonic interaction in crystal results thermal expansion, thermal conductivity, resistance etc.

10. Coefficient of linear Thermal expansion can be given as

$$\alpha = \frac{1}{r_0} \frac{d\langle x \rangle}{dT} = \frac{3g}{r_0^4 c^2} k_B$$

11. Gruneisen parameter is measurement of anharmonicity of a crystal and denoted by γ . Gruneisen assumed that the lattice vibrational frequency ω varies inversely as γ^{th} power of volume.

$$\omega = \frac{c}{V\gamma} \quad \text{and} \quad \gamma = \frac{V}{\omega} \frac{d\omega}{dV}$$

12. In solids, the thermal conduction takes place by two process i.e. conductivity due to free elements and coefficient of free electron thermal conductivity is denoted by K_{el} , and the conductivity due to phonon or lattice vibrations is lattice thermal conductivity K_{lat} .

$$K = K_{el} + K_{lat}$$

Lattice thermal of conductivity can be given as $K_{lattice} = \frac{1}{3} C_V v \lambda$

Electronic thermal conductivity is given as $K_{el} = \frac{1}{3} c_v u_f \lambda_f$

13. If phonons collide with lattice imperfection and with lattice boundaries, they do not establish thermal equilibrium because in such collision there is no change in energy of

phonons. In such process where momentum and energy both remains conserved are called normal process. In such three phonon process

$$K_1 + K_2 = K_3 \text{ with } \omega_1 + \omega_2 = \omega_3$$

14. Due to enharmonic effect, there is umklapp process (U process) where the energy and moment commutation can denote it as

$$K_1 + K_2 = K_3 + G$$

6.15 GLOSSAR

Specific heat of solid: amount of heat required to change the temperature of a substance by 1°C.

Density or states density: number of modes per unit frequency range

Thermal expansion: Change in size of a solid due to change in temperature.

Normal process: If phonons collide with lattice imperfection and with lattice boundaries, if there is no change in energy of phonons, such process where momentum and energy both remains conserved.

Umklapp process (U process): where the energy and moment commutation takes place.

6.16 REFERENCES

1. C Kittel, Introduction to Solid State Physics 7th Edition, John Wiley and Sons, Singapore
 2. H C Gupta, Solid State Physics, Vikas Publication House, New Delhi
- Introduction to Solid State Physics, Arun Kumar, PHI Learning Private Limited, New Delhi

6.17 SUGGESTED READING

1. OS Pillai, Solid state *Physics*, New Age International(P) limited, New Delhi
2. Solid State Devices, B.Somanathan Nair, S.R. Deepa, PHI Learning Private Limited, New Delhi.
3. Fundamentals of Solid State Physics, B.S. Saxena, R.C. Gupta, P.N. Saxena, Pragati Prakashan Meerut.

6.18. TERMINAL QUESTIONS

6.18.1. Short Answer type questions

Q1. What do you mean by classical theory of heat capacity of solids? Explain Dulong-Petit law.

Q2. In Einstein model of heat capacity, explain the behavior of solids at low temperature and high temperature.

Q3. What is Debye model of heat capacity?

Q4. In Debye model of heat capacity, explain the behavior of solids at low temperature and high temperature.

Q5. What are the drawbacks of Einstein model of heat capacity?

Q6. Explain the density of mode. Calculate the density of modes for one dimensional crystal.

Q7. Explain lattice thermal conductivity.

Q8. Compare lattice thermal conductivity and electronic lattice thermal conductivity.

Q9. What is the meaning of Anharmonicity in crystals?

Q10. Explain thermal expansion.

Q. What is Gruneisen parameter? Show that the lattice vibrational frequency ω varies inversely as γ^{th} power of volume.

6.18.2. Long Answer type questions

Q1. Explain the Einstein model of heat capacity. Find out the expression for heat capacity and explain the behavior of solids at low temperature and high temperature.

Q2. Explain the Debye model of heat capacity. Find out the expression for heat capacity and explain the behavior of solids at low temperature and high temperature. How this model is different from Einstein model.

Q3. On the basis on anharmonicity explain the thermal conductivity of solids.

Q4. Find out the thermal expansion for solids on the basis of anharmonicity.

Q5. Calculate the density of state in three dimensional crystals.

UNIT 7**FREE ELECTRON THEORY OF SOLIDS**

Structure

7.1 Introduction

7.2 Objectives

7.3 Free Electron Theory

7.3.1 Lorentz Drude Theory

7.4 Energy levels of free electrons in solid (one dimensional case)

7.4.1 Fermi Energy

7.4.2 Calculation of Fermi energy

7.5 Fermi Dirac distribution for electron gas

7.5.1 Effect of temperature in Fermi Dirac distribution

7.6 Free electron gas in three dimensions

7.6.1 Average Kinetic Energy

7.7 Electrical conductivity

7.8 Thermal Conductivity

7.8.1 Ohm's law from free electron theory

7.9 Electrical conductivity of metals

7.9.1 Effect of Temperature on Conductivity of Metals

7.10 Hall Effect

7.11 Heat Capacity of Electronic Gas

7.12 Summary

7.13 Glossary

7.14 References

7.15 Suggested Readings

7.16 Terminal Questions

7.1 INTRODUCTION

In previous units we studied that many properties of solids can be studied by structure of solids. But many properties of solids like conductivity, electric or magnetic susceptibility can be explained with the help of free electron theory. According to this model it is assumed that the conduction electrons of the atoms leave the atomic shells and move freely inside the solid. The metals are one of the important classes of solids and have a large number of free electrons. For example, electric configuration of magnesium and copper are $\text{Mg}^{12} = 1s^2, 2s^2, 2p^6, 3s^2$ and $\text{Cu}^{29} = 1s^2, 2s^2, 2p^6, 3s^2, 3p^6, 3d^{10}, 4s^1$. The outermost electron of Mg and Cu are $3s^2$ and $4s^1$ respectively, and these electrons leave the orbits, and become free electron. In this theory it is assumed that the motions of free electrons are independent from the motion of ion core. The ion core fill only 15% of the volume of solid the rest of the volume is filled by free electrons.

Further, in lattice vibrations theory, we ignored the effects occurring due to electrons in crystals. We supposed that the electrons surrounding the nucleus of an atom are tightly bound. This assumption is valid for insulators, but not for metal and semiconductors. To understand the properties of metal and semiconductors, it is essential to understand the behavior of electrons. The free electron theory was successful in explaining the properties such as electrical conductivity, thermal conductivity etc. Although, it was unable to explain even the observed facts that why some solids are conductors and some insulators. We know several types of energies associated with the atom, like heat energy, electrical energy, light energy and so on and so forth. But we know that the atoms and molecules can be described by quantum mechanics. In the quantum mechanics the scientists trust on the Fermi energy to define the energy of the electrons. In 1927, Pauli applied quantum statistics to explain the weak para magnetism of alkali metals, that was the first success of the theory. The very subsequent year Sommerfeld published an improved free electron theory by switching classical statistics of Maxwell Boltzmann by Fermi Dirac statistics. The Sommerfeld free electron theory of metal could be better explained as the statistical behavior of the gas obeying Fermi Dirac statistics. In this unit, we shall study concept of free electron theory, Lorenz Drude theory, electrical conductivity, thermal conductivity, Fermi energy, Density of states, heat capacity of free electrons.

7.2 OBJECTIVE

After studying this unit, you should be able to-

- Understand the free electron theory.
- Energy level in one dimension
- Fermi energy and density of states.
- Fermi Dirac energy distribution
- Heat capacity of electron gas
- Apply free electron theory to calculate electrical conductivity, thermal conductivity.

- Hall Effect
- Solve problems using Fermi energy and density of states.

7.3 FREE ELECTRON THEORY

The Drude theory model of electrical conduction was proposed in 1900 by Paul Drude to explain the transport properties of electrons in materials especially metals. The model, which is an application of kinetic theory, assumes that the microscopic behaviour of electrons in a solid may be treated classically and looks much like a pinball machine, with a sea of constantly jittering electrons bouncing and re-bouncing off heavier, relatively immobile positive ions. The metals consist of positive ion cores with valence electrons moving freely among these cores. The electrons are however bound to move within the metal due to electrostatic attraction between the positive ion cores and the electrons. The potential field of these ion cores, which is responsible for such an interaction, is assumed to be constant throughout the metal and mutual repulsion among the electrons is neglected. The behaviour of free electron moving inside the metals considered to be similar to that of atoms or molecules in the perfect gas. These free electrons are therefore referred to as free electron gas and the theory is named as free electron gas model. These free electrons are known as the conduction electrons. The total energy of conduction electron is equal to its kinetic energy. Also, since the movement of conduction electrons is restricted to within the crystal only, the potential energy of a stationary electron inside metals is less than the potential energy of identical electrons just outside it. This energy difference serves as the potential barrier and stops the inner electrons from leaving the surface of the metal. Thus, in free electron Gas model, the movement of free electrons in a metal is equivalent to the movement of free electron gas inside a potential energy box.

7.3.1 Lorentz Drude Theory

The Drude model is a purely classical model and treats both electrons and ions as solid spheres. On the basis of Drude considerations that the electron gas behaves as perfect gas, Lorentz postulated in 1909 that the electrons constituting the electron gas obey Maxwell Boltzmann statistics under the equilibrium conditions. These shared ideas of Drude and Lorentz establish the Drude Lorentz theory. The basic assumptions of Lorentz Drude theory are

- (i) In metals, there is large number of free electrons. These electrons are free to move about the volume of the metal as the molecules of a perfect gas in a container,
- (ii) Free electron motion in a metal is similar to the thermal agitation of a perfect gas. The assembly of free electrons in a metal is called the electron gas. The electrical and thermal conductivity of metals is due to these free electrons.
- (iii) In metals, the free electrons move randomly in all possible directions with different velocity like the molecules of a perfect gas. The average kinetic energy of an electron is $3kT/2$, where k is Boltzmann's constant and T absolute temperature.

- (iv) In the lattice, the free electrons make collisions from time to time with fixed positive ions.
- (v) In the absence of external electrical field, the random motion of free electrons is equally probable along all directions. In presence of external electric field, the electrons drift slowly with some average velocity, known as average drift velocity, in the direction opposite to that of electric field.
- (vi) The free electrons are accelerated and gain some additional kinetic energy in the presence of external electric field. The accelerated free electron on collision with positive ion fixed in the lattice loses its additional kinetic energy. Such a collision is called inelastic collision.
- (vii) Between two successive collisions with the positive ions, the average distance traversed by the free electron is known as mean free path denoted by λ .

7.4 ENERGY LEVELS of FREE ELECTRONS in SOLIDS (One Dimensional case)

Consider a free electron gas in a one dimensional case. By quantum mechanics we can find out the energy levels and wave function for electron gas. For simplicity, first we consider one dimensional case and we can extend the same theory for three dimensional case. Suppose an electron of mass m confined to a length L by infinite barrier and ε_n is the energy of n th orbit. If the wave function for such electron is ψ_n , then Schrodinger wave equation can be given as

$$E\psi = H\psi$$

$$\varepsilon_n\psi_n = -\frac{\hbar^2}{2m} \frac{d^2\psi_n}{dx^2} + V\psi_n \quad (7.1)$$

For free electron we neglect the potential energy term V then

$$-\frac{\hbar^2}{2m} \frac{d^2\psi_n}{dx^2} = \varepsilon_n\psi_n \quad (7.2)$$

$$\frac{d^2\psi_n}{dx^2} + k^2 \psi_n = 0 \quad \text{where } \frac{2m\varepsilon_n}{\hbar^2} = k^2 \quad (7.3)$$

Mathematically the solution of above equation can be given as

$$\psi_n = A \sin kx + B \sin kx \quad (7.4)$$

where A and B are constants.

Using boundary conditions in eq. 7.4 as

At $x=0$, $\psi_n = 0$ then $0 = 0 + B \sin kx \Rightarrow B = 0$

At $x=L$, $\psi_n = 0$ then $0 = A \sin kL \Rightarrow kL = n\pi \Rightarrow k = \frac{n\pi}{L}$

Thus the wave function $\psi_n = A \sin \frac{n\pi}{L} x$ (7.5)

From eq. 7.3 Energy of nth level $\epsilon_n = \frac{\hbar^2}{2m} (k^2) = \frac{\hbar^2}{2m} \left(\frac{n\pi}{L}\right)^2$ (7.6)

Equation 7.5 and 7.6 represent the wave function and energy of free electron in a solid, as shown in figure 7.1. Wave function has a sine wave shape. If there is N number of electrons in the solid than according to Pauli principle, no two electrons have same set of all quantum numbers. Thus the orbits can be filled in such a manner that each electron has different quantum number. However, one orbit may have same energy. The number of orbital with same energy is called degeneracy. If we start the filling of electrons from bottom $n=1$, and continue the filling the higher levels until all N electrons are accommodated then the topmost filled level is called Fermi level and denoted by n_F .

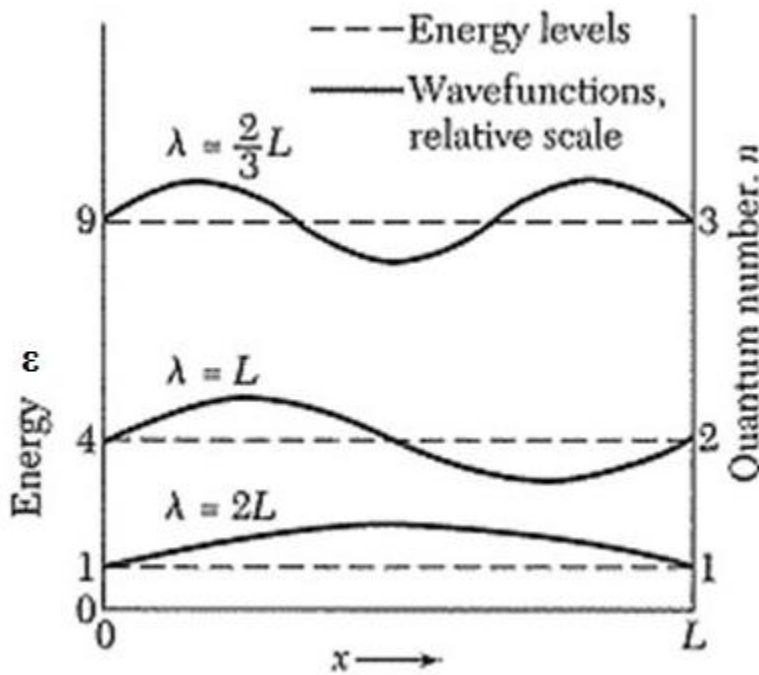

Figure 7.1: Wave function and energy states of free electron in a solid.

7.4.1 Fermi Energy

Fermi energy is defined as the energy of the topmost filled level in the ground state of N electrons. As given in equation 7.6 the Fermi energy can be given as

$$\varepsilon_F = \frac{\hbar^2}{2m} \left(\frac{n_F \pi}{L} \right)^2 \quad (7.7)$$

. The Fermi energy is a concept in quantum mechanics usually referring to the energy difference between the highest and lowest occupied single-particle states in a quantum system of non-interacting fermions at absolute zero temperature. In a Fermi gas, the lowest occupied state is taken to have zero kinetic energy, whereas in a metal, the lowest occupied state is typically taken to mean the bottom of the conduction band.

7.4.2 Calculation of Fermi Energy

Suppose a given metal contains N free electrons. We can calculate its Fermi energy by filling up its energy states. At $T=0$, starting from $\varepsilon = 0$, all quantum states upto $\varepsilon = \varepsilon_F$ are filled.

That is

$$N = \int_0^{\varepsilon_F} n(\varepsilon) d\varepsilon$$

$$\text{or, } N = \frac{8\sqrt{2}}{h^3} \pi V m^{3/2} \int_0^{\varepsilon_F} \varepsilon^{1/2} d\varepsilon$$

$$\text{or we get, } \varepsilon_F = \frac{\hbar^2}{2m} \left(\frac{3N}{8\pi V} \right)^{2/3} \quad (7.8)$$

This is the expression for the Fermi energy of a metal at $T=0$, the N/V is the density of free electrons. Thus, the Fermi energy is independent of the size of metal. Fermi energy can be written in terms of Fermi temperature defined as $\varepsilon_F = kT_F$, where k is the Boltzmann's constant

7.5 FERMI DIRAC DISTRIBUTION FOR ELECTRON GAS IN METAL

In a metallic solid, the valence electrons are loosely bound to the individual atoms; we can treat these electrons as an ideal electron gas. Since electrons are Fermi particles, they obey Pauli's exclusion principle and Fermi Dirac distribution law.

According to this law, the number of electrons n_i with energy ε_i is given by

$$n_i = \frac{g_i}{e^{\varepsilon_i - \varepsilon_F / k_B T} + 1}, \quad (7.9)$$

where g_i is the number of quantum states having the energy ε_i

In a solid, there are 10^{22} to 10^{23} atoms/ cm^3 and the same number of valence electrons. As such there are an enormous number of quantum states which the electron can occupy.

So, the number of electrons in energy ranges ε to $\varepsilon + d\varepsilon$

$$n(\varepsilon)d\varepsilon = \frac{g(\varepsilon)d\varepsilon}{e^{\varepsilon - \varepsilon_F / k_B T} + 1} \quad (7.10)$$

where $g(\varepsilon)d\varepsilon$ is the number of quantum states available to these electrons.

It can be shown that the number of allowed energy values between ε to $\varepsilon + d\varepsilon$ is

$$g(\varepsilon)d\varepsilon = \frac{4\sqrt{2}}{h^3} \pi V m^{3/2} \varepsilon^{1/2} d\varepsilon, \text{ where } m \text{ is the mass of electron and } V \text{ is the volume of the electron gas.}$$

Since there are two possible spin states $(+\frac{1}{2}, -\frac{1}{2})$ for an electron, each energy value can have by two electrons.

Therefore, the number of energy states available to the electrons having energy between ε to $\varepsilon + d\varepsilon$ is given by

$$g(\varepsilon)d\varepsilon = \frac{8\sqrt{2}}{h^3} \pi V m^{3/2} \varepsilon^{1/2} d\varepsilon \quad (7.11)$$

$$\text{Hence } n(\varepsilon)d\varepsilon = \frac{8\sqrt{2}}{h^3} \pi V m^{3/2} \varepsilon^{1/2} \frac{1}{e^{(\varepsilon - \varepsilon_F / k_B T)} + 1} d\varepsilon \quad (7.12)$$

$n(\varepsilon)$, is known as Fermi Dirac distribution function which give the number of electrons in an energy state ε_F .

7.5.1 Effect of Temperature on Electron Distribution in Solids

The ground state is a state at which all N atoms at absolute zero temperature. Now we will see the behaviours of electron distribution at different energy levels when temperature increases. For simplicity, above distribution function can be given as

$$P(1, \varepsilon_F) = \frac{1}{\exp((\varepsilon - \mu) / kT) + 1} \quad (7.13)$$

Where P probability distribution in energy state ε_F at temperature T, μ is chemical potential. The kinetics energy of electron gas increases with temperature. When temperature increases, some energy states become occupied which were vacant at absolute zero and some states become vacant which were occupied at absolute zero temperature. Fermi-Dirac distribution function

gives the probability that an orbit of energy ε_F at temperature T will be occupied in an electron gas in thermal equilibrium. Equation 7.13 can be given as

$$f(\varepsilon) = \frac{1}{e^{(\varepsilon - \varepsilon_F)/kT} + 1} \quad (7.14)$$

Some time we use Chemical potential (μ) in place of Fermi energy ε_F , which is function of temperature.

At temperature $T=0$; if $\varepsilon > \varepsilon_F$ eq. 7.14 becomes

$$f(\varepsilon) = \frac{1}{e^{(\varepsilon - \varepsilon_F)/0} + 1} = \frac{1}{e^\infty + 1} = 0$$

And At temperature $T=0$; if $\varepsilon < \varepsilon_F$ eq. 7.14 becomes

$$f(\varepsilon) = \frac{1}{e^{(\varepsilon - \varepsilon_F)/0} + 1} = \frac{1}{e^{-\infty} + 1} = 1$$

Therefore at temperature $T=0$, the function $f(\varepsilon)$ changes from the value 1 (filled state) to 0 (empty state) as shown in figure 7.2. At absolute zero temperature $\mu = \varepsilon_F$. It is clear from the picture, the Fermi energy ε_F is the energy of topmost filled orbit at absolute zero. At absolute zero temperature, all states have energy more than Fermi energy, are empty as $f(\varepsilon) = 0$.

At all temperature $T \neq 0$, if $\varepsilon = \varepsilon_F$,

$$f(\varepsilon) = \frac{1}{e^0 + 1} = \frac{1}{1 + 1} = 1/2$$

The $f(\varepsilon)$ if is equal to 1/2. Thus at all temperature $T \neq 0$, at Fermi level the Fermi Dirac distribution function becomes $1/2$ as shown in figure 7.2.

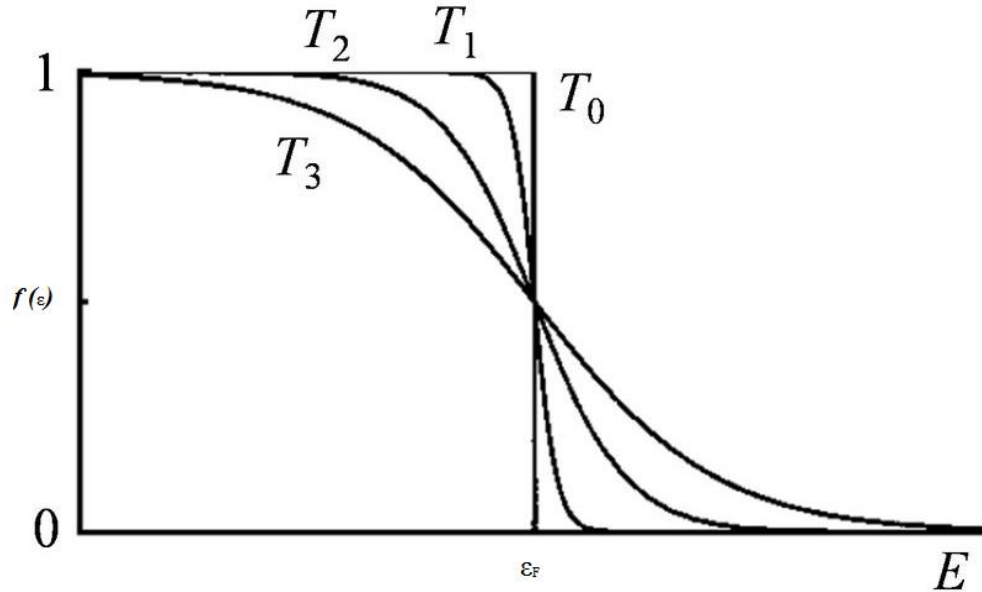

Figure 7.2: Fermi Dirac distribution function

7.6. FREE ELECTRON GAS IN THREE DIMENSIONS

Consider the behavior of free electron gas in 3D metallic crystal. The potential of the electrons inside the crystal is constant and may be taken zero, whereas it has a large value outside the crystal. For simplicity, the 3D crystal may be regarded as a cubical box having length of the edge equal to L . the free particle Schrodinger equation in 3D is given as

$$\nabla^2 \psi_k(r) + \frac{2m}{\hbar^2} E_k \psi_k(r) = 0 \quad (7.15)$$

This is standard equation and the solution of it given by

$$\psi_k(x) = A e^{i\vec{k} \cdot \vec{r}} = A e^{i(k_x x + k_y y + k_z z)} \quad (7.16)$$

Where, A is an arbitrary constant. Such wave function must satisfy the periodic boundary conditions. They must be periodic in x, y, z with period equal to L . these boundary conditions are

$$\psi_k(x + L, y, z) = \psi_k(x, y, z) \quad (7.17)$$

$$\psi_k(x, y + L, z) = \psi_k(x, y, z)$$

$$\psi_k(x, y, z + L) = \psi_k(x, y, z)$$

An application of the first boundary condition in (7.17) to the wave function (7.16) gives

$$e^{ik_x L} = 1$$

$$\text{or, } k_x = 0, \pm \frac{2\pi}{L}, \pm \frac{4\pi}{L}, \dots$$

Similar results are obtained for k_y, k_z

The allowed Eigen values of the state or orbital with wave vector k are obtained

$$E_k = \frac{\hbar^2 k^2}{2m} = \frac{\hbar^2}{2m} (k_x^2 + k_y^2 + k_z^2) \quad (7.18)$$

Where the magnitude of the wave vector k is related to the wavelength λ as

$$k = \frac{2\pi}{\lambda}$$

Thus, it is easy to see the energy spectrum consists of discrete energy levels. These energy levels are very close to each other.

In a system of N free electrons, the occupied states or orbitals in the ground state may be represented by points inside a sphere in the k space. The energy corresponding to the surface of the sphere represents the Fermi energy as shown in figure 5.2. Let k_F be the wave vector from the origin of the k space to the surface of the sphere. Then the Fermi energy is written as

$$E_F = \frac{\hbar^2 k_F^2}{2m} \quad (7.19)$$

Fermi sphere volume is given by

$$\frac{4}{3} \pi k_F^3$$

Volume occupied by one state in k space

$$\left(\frac{2\pi}{L}\right)^3$$

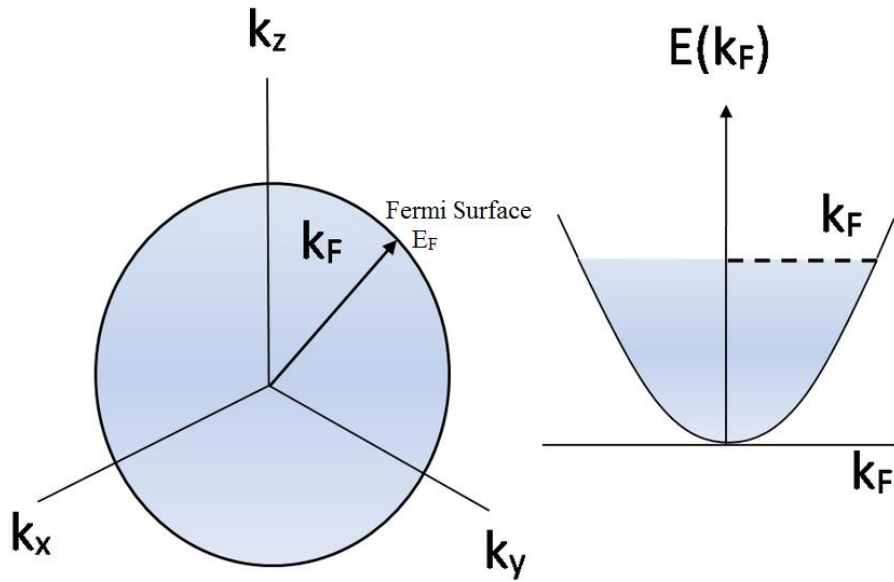

Figure 7.3: Fermi Sphere and surface in k space, k_F is radius of Fermi sphere.

The total number of electronic states or orbitals is (the number of states is equal to number of electrons)

$$N = (2) \frac{4}{3} \pi k_F^3 / \left(\frac{2\pi}{L}\right)^3 \quad (7.20)$$

Where a factor 2 appears because there are two allowed values for each orbital. So, we get

$$k_F = \left(\frac{3\pi^2 N}{V}\right)^{1/3} \quad (7.21)$$

Therefore, eq (7.20) and (7.21), we get the expression of Fermi energy

$$\varepsilon_F = \frac{\hbar^2}{2m} \left(\frac{3\pi^2 N}{V}\right)^{2/3} \quad (7.22)$$

The electron velocity v_F at the Fermi surface is obtained

$$v_F = \frac{\hbar k_F}{m} = \frac{\hbar}{m} \left(\frac{3\pi^2 N}{V}\right)^{1/3} \quad (7.23)$$

(Particle velocity is given by $v_F = \hbar k_F / m$)

The density of state function is obtained by using the fact that at absolute zero, all the energy states below Fermi energy are occupied and the total number of states is equal to the number of electrons.

$$N = \int_0^{\epsilon_F} D(\epsilon) f(\epsilon) d\epsilon \quad (7.24)$$

$$N = \frac{V}{3\pi^3} \left(\frac{2m\epsilon}{\hbar^2} \right)^{3/2}$$

So, from (7.24) and (7.22), on solving we get

$$D(\epsilon) = \frac{dN}{d\epsilon} = \frac{V}{2\pi^2} \left(\frac{2m}{\hbar^2} \right)^{3/2} \epsilon^{1/2} \quad (7.25)$$

Figure 7.4 shows the Density of state as a function of energy. The dashed line represents the density function of filled orbitals at finite temperature. If kT is small comparative to Fermi energy, it represents the filled orbitals at 0K. If average energy increases, the electrons are shifted from region 1 to 2.

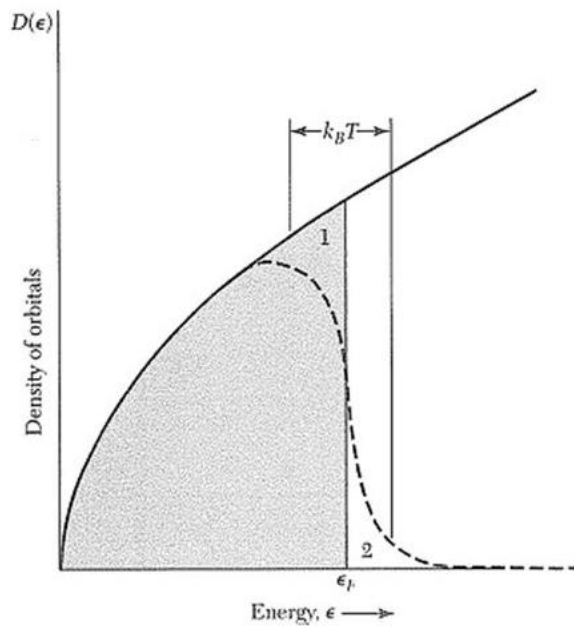

Figure 7.4: Density of state as a function of energy

7.6.1 Average Kinetic Energy

Average Kinetic Energy is defined as

$$\bar{\varepsilon} = \frac{1}{N} \int_0^{\varepsilon_F} \varepsilon D(\varepsilon) f(\varepsilon) d\varepsilon$$

Putting the values of $D(\varepsilon)$ and Fermi function and integrating we get

$$\bar{\varepsilon} = \frac{3}{5} \varepsilon_F$$

or we can write at absolute zero as

$$\bar{\varepsilon}_0 = \frac{3}{5} \varepsilon_{F_0} \quad (7.26)$$

7.7 ELECTRICAL CONDUCTIVITY

Let the time taken between two successive collisions be τ and velocity along one direction u , then

$$\tau = \frac{\lambda}{u}, \text{ where } \lambda \text{ is the mean free path}$$

If the applied field on the electron of charge $-e$ be E , then the equation of motion of electron is

$$m \frac{d^2x}{dt^2} = -eE$$

$$\text{or, } \frac{d^2x}{dt^2} = -eE / m$$

Integrating it, we get

$$\frac{dx}{dt} = -\frac{eE}{m}t + C$$

At $t=0$, $dx/dt=0$

Therefore $C=0$

$$\text{Hence, } \dot{x} = \frac{dx}{dt} = -\frac{eE}{m}t$$

Average velocity between two collisions is defined as

$$\bar{x} = -\frac{1}{\tau} \int_0^{\tau} \frac{eE}{m} t dt$$

On solving we get

$$\bar{x} = \frac{eE \tau}{m 2}$$

If J is the current density and n the number of electrons per unit volume, then we have

$J = -n e \bar{x}$, putting the values, we get,

$$J = \frac{1}{2} \frac{n e^2 E \tau}{m u} \quad (7.27)$$

Since we know $\frac{1}{2} m u^2 = 3kT$ (7.28)

Therefore from eq.(7.27) and eq. (7.28), we get

$$J = \frac{n e^2 E \lambda u}{6kT} \quad (7.29)$$

or $J = \sigma E$

where $\sigma = \frac{n e^2 \lambda u}{6kT}$ (7.30)

which is defined as electrical conductivity.

7.8 THERMAL CONDUCTIVITY

Thermal conductivity is a process in which heat is transferred from one part of the body to another as a result of temperature gradient. In order to calculate the thermal conductivity, let us draw three parallel planes at E X and F, as shown in figure 7.5, normal to the direction of heat flow which are separated by mean free path λ , if two temperatures are equal, $T_1=T_2$, then there is no exchange of energy.

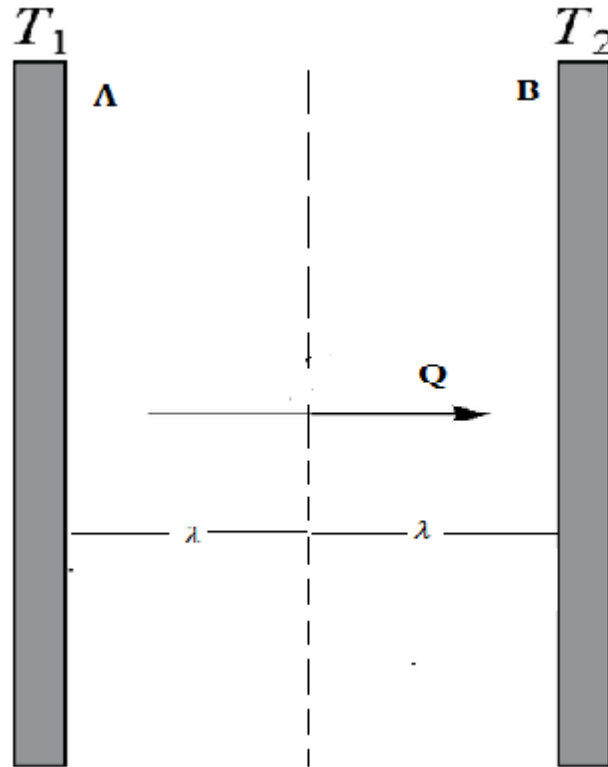

Figure 7.5: Heat conduction from one part of body to another

If T_1 is greater than T_2 , there is an exchange of energy from A to B, therefore the number of electrons per unit area per unit time is $\frac{nu}{6}$ and each electron has energy $\frac{mu_1^2}{2}$.

Thus, Energy transferred from A to B

$$= \frac{nu}{6} \frac{mu_1^2}{2}$$

$$= \frac{nu}{6} \frac{3k_B T_1}{2}$$

$$= \frac{1}{4} nu k_B T_1$$

Likewise, the energy transferred from B to A

$$= \frac{1}{4} nu k_B T_2$$

Therefore, the net energy transferred from A to B per unit area per unit time

$$= \frac{1}{4} n u k_B (T_1 - T_2)$$

Therefore, the transfer of energy per unit area per unit time, when K is the thermal conductivity

$$= \frac{K(T_1 - T_2)}{2\lambda}$$

On solving

$$K \frac{(T_1 - T_2)}{2\lambda} = \frac{1}{4} n u k (T_1 - T_2)$$

$$K = \frac{1}{2} \lambda n u k_B \tag{7.31}$$

where k_B is Boltzmann constant.

Dividing (7.31) by (7.30), we get $\frac{K}{\sigma} = \frac{1}{2} \lambda n u k_B / \frac{n e^2 \lambda u}{6kT}$

$$\text{or } \frac{K}{\sigma} = 3(k_B / e)^2 T \tag{7.32}$$

or $\frac{K}{\sigma} \propto T$, or $\frac{K}{\sigma} = LT$. This is known as Wiedemann-Franz relation where the constant of proportionality L is called the Lorenz number. For metals, the thermal conductivity is quite high, and those metals which are the best electrical conductors are also the best thermal conductors. At a given temperature, the thermal and electrical conductivities of metals are proportional, but raising the temperature increases the thermal conductivity while decreasing the electrical conductivity. This behaviour is viewed in the Wiedemann-Franz Law.

Qualitatively, this relationship is based upon the fact that the heat and electrical transport both involve the free electrons in the metal. The thermal conductivity increases with the average particle velocity since that increases the forward transport of energy. However, the electrical conductivity decreases with particle velocity increases because the collisions divert the electrons from forward transport of charge. This means that the ratio of thermal to electrical conductivity depends upon the average velocity squared, which is proportional to the kinetic temperature.

Self-Assessment Question (SAQ) 1: A uniform copper wire of length 0.5 m and diameter 0.3 mm has a resistance of 0.12 Ohm at 293 k. If the thermal conductivity of the specimen at the same temperature is $390 \text{ Wm}^{-1}\text{K}^{-1}$, calculate the Lorentz number. Compare the value with the theoretical value.

7.8.1 Ohm's Law from Free Electron Theory

We know from Lorentz-Drude theory, $J = \sigma E = \frac{ne^2\lambda}{mv_F}$, if I is the current flowing through a conductor of l length and area of cross section A and potential difference V , then

$$J = I / A \text{ and } E = V / l$$

$$\text{or, } I / A = \frac{ne^2\lambda V}{mv_F l}$$

or. $I = \frac{ne^2\lambda AV}{mv_F l}$ for a given conductor, if the physical conditions do not change l , A , λ , v_F are constant.

Hence, $I \propto V$, that is at given physical conditions the current flowing through a conductor is proportional to the potential difference across it. That is Ohm's law.

7.9 ELECTRICAL CONDUCTIVITY OF METALS

The mechanism of electrical conductivity of metal can be understood by the free electron theory. The crystal lattice of a metal consists of positive ions at the lattice points and the valence electrons free to move inside the crystal. When there is no electric field applied, the free electrons move in the random direction inside the crystal. It is because of that the electrons collide frequently with the imperfection in the crystal lattice, which occurs with the thermal vibrations of the ions about their equilibrium positions in the lattice and also from the presence of impurity ions. Following each collision, the electron is scattered in the new directions with new speeds, which makes their random motion. Let τ be the average time between successive collisions of an electron, which gives $\tau = \frac{\lambda}{v_F}$. Where λ is the average distance between collisions and v_F is the speed of those

electrons whose kinetic energy is equal to the Fermi energy. It should be noted that electrons which are near the Fermi level contribute to the conductivity. In the presence of applied the electric field to the metal, the electrons modify their random motion in such a way that on an average they drift slowly in the direction opposite to that of the field (since electrons have negative charge) with a small speed, which is known as drift velocity, v_d . When electric field is applied to an electron in the metal exerts on it a force eE , which gives acceleration to electron, that is

$a = \frac{eE}{m}$, where e and m are the charge and mass of electron respectively. Consider an electron that

has just collided with the lattice imperfection. The drift speed of electron has become momentarily zero and it would now move in a purely random direction, gaining a drift speed $a\tau$ just before its succeeding collision. Therefore, the average drift speed during the interval of τ is given as

$$v_d = \frac{a\tau}{2}$$

$$\text{or, } v_d = \frac{eE\tau}{2m}$$

placing the value of τ , we get

$$v_d = \frac{eE\lambda}{2mv_F}$$

If n is the number of electrons per unit volume in the conduction band of the metal, then the current density j is given as

$$j = nev_d$$

$$\text{or, } j = \frac{ne^2 E\lambda}{2mv_F}$$

We know the resistivity ρ of the metal, which is defined as

$$\rho = \frac{E}{j}$$

Hence, we obtain

$$\rho = \frac{2mv_F}{ne^2\lambda}$$

This form is a sort of Ohm's law, since the quantities v_F and λ which determine ρ do not depend on the applied field. Therefore, at given temperature the resistivity ρ is a constant for a given metal.

Since conductivity of metal is defined as

$$\sigma = 1/\rho$$

$$\text{or, } \sigma = \frac{ne^2\lambda}{2mv_F} \quad (7.33)$$

Mobility is defined as

$$\mu = v_d / E$$

$$\text{or, } \mu = \frac{e\lambda}{2mv_F}$$

Putting this expression in equation (7.33), we get

$$\sigma = ne\mu$$

This is the general expression for conductivity. If the conductivity is due to holes and electrons, then the expression becomes

$$\sigma = n_e e \mu_e + n_h e \mu_h$$

Where, μ_h and μ_e are the mobility due to holes and electrons respectively.

7.9.1 Effect of Temperature on Conductivity of Metals

On increasing temperature of the metals, its conductivity decreases and the resistivity increases. In the metallic lattice, metals have electrical resistivity due to the scattering of free electrons by the imperfections. There are two types of imperfections.

1. Occurring due to the thermal vibrations of the positive ions about their equilibrium positions in the lattice.
2. Occurring due to structural defects as presence of impurity ions. Hence the resistivity of a metal can be given as

$$\rho = \rho_t + \rho_i$$

Here ρ_t the resistivity due to thermal imperfections and ρ_i is caused by impurity or structural imperfections. As the temperature increases, the amplitude of ion vibrations increases, because of that the scattering cross section of the ions increases. Hence, the resistivity ρ_t increases. The vibration of ρ_t with temperature is of the form $\rho_t \propto T^5$ at low temperature and $\rho_t \propto T$ at high temperatures. We can explain metallic resistivity by this expression

$$\rho \propto \frac{v_F}{\lambda}$$

On rising temperature, the electron speed v_F increases and the mean free path λ decreases, therefore, the resistivity ρ increases. On the other hand, the resistivity ρ_i is independent upon the temperature.

7.10 HALL EFFECT

If a current carrying conductor placed in a perpendicular magnetic field, a potential difference will generate in the conductor which is perpendicular to both magnetic field and current. This phenomenon is called Hall Effect. Hall Effect is an important tool to characterize the materials especially semiconductors. It directly determines both the sign and density of charge carriers in a given sample.

Consider a rectangular conductor of thickness d kept in XY plane as shown in figure 7.6. An electric field is applied in X-direction so that current I flow through the sample. If w is the width of the sample and d is the thickness. There for current density is given by

$$J_x = I/wd$$

(7.34)

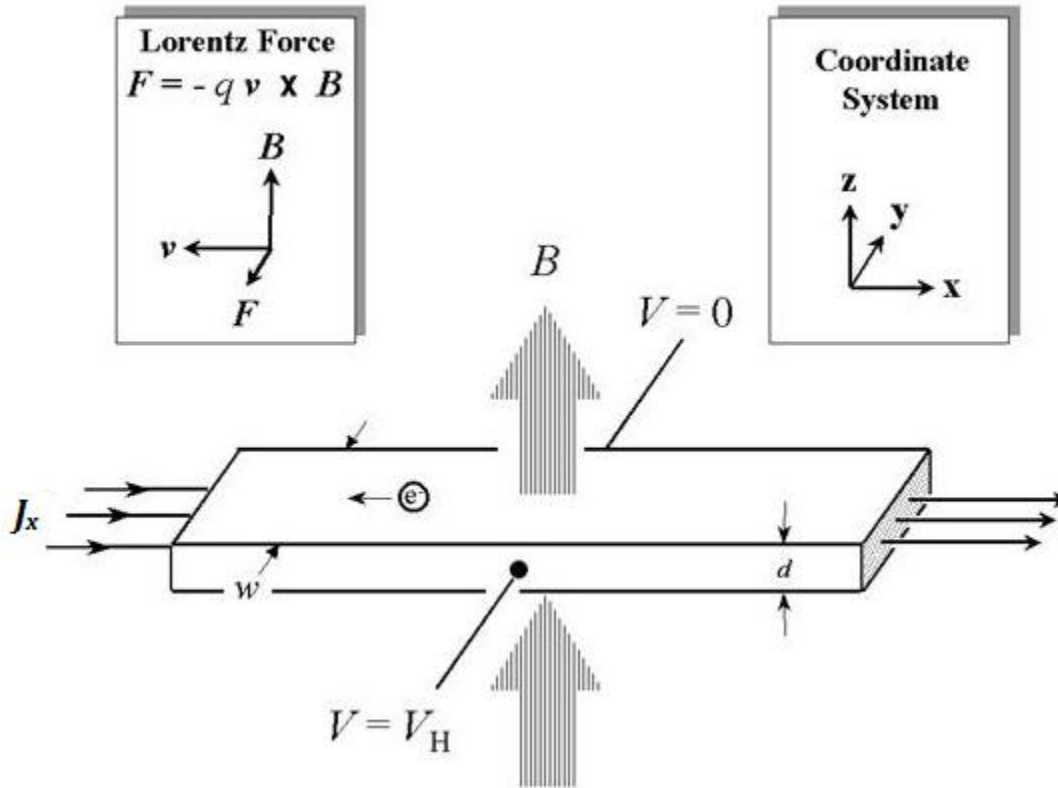

Figure.7.6: Schematic representation of Hall Effect in a conductor. J_x – current density, B – applied magnetic field, d – thickness, w – width, V_H – Hall voltage

If the magnetic field is applied along negative z -axis, the Lorentz force moves the charge carriers (say electrons) toward the y -direction. This results in accumulation of charge carriers at the top edge of the sample. This set up a transverse electric field \mathbf{E}_y in the sample. This develop a potential difference along y -axis is known as Hall voltage V_H and this effect is called Hall Effect. A current is made to flow through the sample material and the voltage difference between its top and bottom is measured using a volt-meter. When the applied magnetic field $B=0$, the voltage difference will be zero.

We know that current flows in response to an applied electric field with its direction as conventional and it is either due to the flow of holes in the direction of current or the movement of electrons backward. In both cases, under the application of magnetic field the magnetic Lorentz force $F = q(\mathbf{v} \times \mathbf{B})$, causes the carriers to curve upwards. Since the charges cannot escape from

the material, a vertical charge imbalance builds up. This charge imbalance produces an electric field which counteracts with the magnetic force and a steady state is established. The vertical electric field can be measured as a transverse voltage difference using a voltmeter. In steady state condition, the magnetic force is balanced by the electric force. Mathematically we can express it as

$$eE = eVB \quad (7.35)$$

Where 'e' the electric charge, 'E' the hall electric field developed, 'B' the applied magnetic field and 'v' is the drift velocity of charge carriers. And the current 'I' can be expressed as,

$$I = neAv \quad (7.36)$$

Where 'n' is the number density of electrons in the conductor of length l, breadth 'w' and thickness 'd'.

Using (7.33) and (7.34) the Hall voltage V_H can be written as,

$$V_H = Ew = vBw$$

Putting value of v from above eq. 7.36

$$V_H = \frac{IB}{ned}$$

$$V_H = R_H \frac{IB}{d} \quad (7.37)$$

Where eq. 7.37 gives Hall Voltage. The Hall coefficient R_H is defined as

$$R_H = \frac{1}{ne} = \frac{E_y}{J_x B} \quad (7.38)$$

7.11 HEAT CAPACITY OF FREE ELECTRON GAS

Electron heat capacity or electronic specific heat describes the contribution of electrons to the heat capacity. Heat is transported by phonons and by free electrons in solids. For pure metals, however, the electronic contributions dominate in the thermal conductivity. In impure metals, the electron mean free path is reduced by collisions with impurities, and the phonon contribution may be

comparable with the electronic contribution. Theoretically the specific heat of metal shall get contribution from the atoms as well as free electrons

$$c = c_{atomic} + c_{electronic}$$

Since the T_F (Fermi Temperature) is of the order of 10^4 K, as the temperature increase some of the electrons close to the Fermi energy level are moved to occupy higher energy states due to the thermal excitation (around 100K). It is only a fraction of electrons with energy near Fermi energy which can be excited. For most electrons, the states to which they will be excited are already occupied and because of the Pauli exclusion principal, they cannot be excited into these states.

The electrons in the metal which contribute to conduction are very close to the Fermi level. But to contribute to bulk specific heat, all the valence electrons would have to receive energy from the thermal energy $k_B T$. But the Fermi energy ($k_B T_F$) is much greater than thermal energy, and the majority of the electrons cannot receive such energy since there are no available energy levels within of their energy.

The small fraction of electrons which are within $k_B T$ of the Fermi level does contribute a small specific heat, and this electron specific heat becomes significant at very low temperatures. Using Fermi-Dirac statistics (as opposed to Einstein-Bose for phonons), a small fraction of the electrons is available to participate in specific heat. This fraction contributes a specific heat.

Excited electrons will be only fraction given by

$$k_B T / k_B T_F$$

$k_B T_F$ Corresponds to all the states and $k_B T$ corresponds to the energy of thermal excitation.

$k_B T / k_B T_F = T / T_F$, These are the fraction of electrons excited thermally. And each of them has the excitation of $k_B T$. Therefore, the excitation energy is of the order of

$$k_B T (T / T_F)$$

$$\text{Or, } \varepsilon = k_B T^2 / T_F$$

By definition of specific heat

$$c_e = \frac{d}{dT} (k_B T^2 / T_F)$$

$$c_e = 2k_B T / T_F, \text{ or we can write}$$

$$c_e = \gamma T, \text{ where } \gamma = (2k_B / T_F) \text{ is constant.}$$

We know by Debye theory the specific heat due to lattice vibration

$$c_{atomic} = \beta T^3$$

Thus, the total specific heat as shown in figure 5.4, is given by the sum of these two

$$c = c_{atomic} + c_{electronic} = \beta T^3 + \gamma T$$

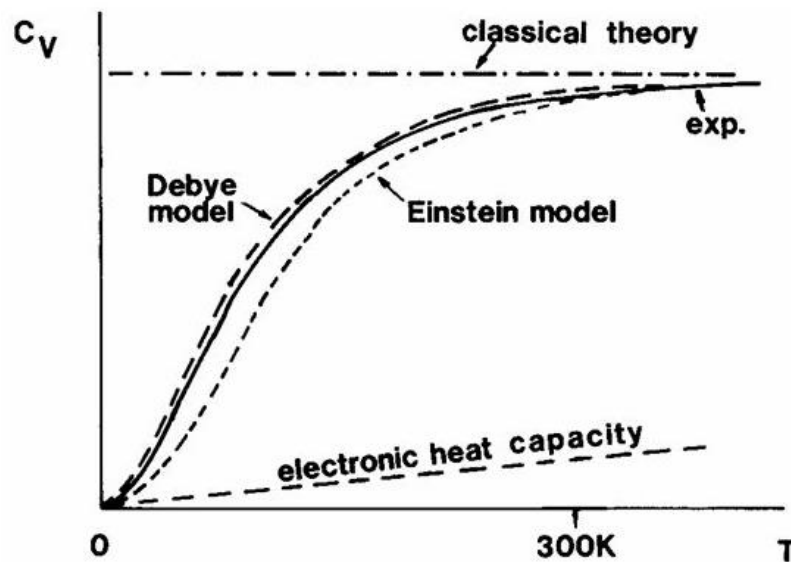

Figure 7.7: Specific heat with temperature

At very low temperature the atomic specific heat becomes small and the electronic specific heat becomes relatively high. For, example the atomic heat of silver becomes very small compared to its electronic specific heat from the temperature range 3K. In specific heat measurement Keesom and Cock found that in the range from 1.5 to 3K the specific heat varies according to $c_e = \gamma T$. This suggests that below the 3K for silver, free electrons become the chief contributor to the specific heat. Thus, the Fermi Dirac statistics has solved the problem of specific heat of metals.

Self-Assessment Question (SAQ) 2: Calculate the Fermi energy in electron volts for sodium assuming that it has one free electron per atom. Given density of sodium = 0.97 g cm^{-3} , atomic weight of sodium = 23.

Self-Assessment Question (SAQ) 3: Consider silver in metallic state with one free conduction electron per atom. Calculate its Fermi energy. The density of silver is 10.5 gram/cm^3 and its atomic weight is 108. The Avogadro's number is 6.02×10^{23} atoms/mole.

Self-Assessment Question (SAQ) 4: The Fermi energy for lithium is 4.72 eV at absolute zero. Calculate the number of conduction electrons per unit volume in lithium. ($h = 6.67 \times 10^{-34}$ J-sec, $m = 9.1 \times 10^{-31}$ kg, $k = 1.38 \times 10^{-23}$ J/K)

Examples 1: Calculate the Fermi energy in electron volts for sodium assuming that it has one free electron per atom. (Atomic weight of sodium = 23, density of sodium = 0.97 g cm^{-3})

Solution: we have the expression of Fermi energy $\varepsilon_F = \frac{\hbar^2}{2m} \left(\frac{3\pi^2 N}{V} \right)^{2/3}$ or

$$\varepsilon_F = \frac{\hbar^2}{8m} \left(\frac{3N}{\pi V} \right)^{2/3}$$

First calculate $N/V = \frac{N_A \rho}{W}$

We know $N_A = 6 \times 10^{26} \text{ atoms / kg.mole}$

Given $\rho = 0.97 \text{ g.cm}^{-3}$

or, $\rho = 0.97 \times 10^3 \text{ kg / m}^3$

$$N/V = \frac{N_A \rho}{W} = 2.53 \times 10^{28} \text{ electrons / m}^3$$

Planck's constant $h = 6.62 \times 10^{-34}$ joule sec, mass of the electron $m = 9.1 \times 10^{-31}$ kg

Putting all these values in $\varepsilon_F = \frac{\hbar^2}{2m} \left(\frac{3\pi^2 N}{V} \right)^{2/3}$, we get

$$\varepsilon_F = 5.032 \times 10^{-10} \text{ joules}$$

$$\text{Or, } \varepsilon_F = 5.032 \times 10^{-10} / 1.6 \times 10^{-19} = 3.14 \text{ eV}$$

Example 2: There are 2.54×10^{22} free electrons per cm^3 in sodium. Calculate its Fermi energy, Fermi velocity and Fermi temperature. ($h = 6.67 \times 10^{-34}$ Jsec, $m = 9.1 \times 10^{-31}$ kg, $k = 1.38 \times 10^{-23}$ J/K,

$1 \text{ eV} = 1 \times 10^{-19}$ joule)

$$\text{Solution: } \varepsilon_F = \frac{\hbar^2}{2m} \left(\frac{3\pi^2 N}{V} \right)^{2/3}$$

First calculate $N/V = 2.54 \times 10^{28} / \text{m}^3$, putting in above equation, with the values of m and h , we get

$$\varepsilon_F = 5.0 \times 10^{-19} \text{ J} = 3.1 \text{ eV}$$

At absolute zero, this is the maximum kinetic energy of the free electron

$$\frac{1}{2}mv_F^2 = 5.0 \times 10^{-19} J$$

Therefore, on solving $v_F = 1.05 \times 10^6 m/s$

$$\text{Fermi temperate is defined as } T = \frac{\varepsilon_F}{k} = \frac{5.0 \times 10^{-19}}{1.38 \times 10^{-23}} = 3.6 \times 10^4 K$$

Example 3: The Fermi energy in silver is 5.51 eV. What is the average energy of the electrons in silver at 0K? At what temperature a classical free particle will have this kinetic energy.

Solution: At 0K the average energy of an electron is $\bar{\varepsilon}_0 = \frac{3}{5} \varepsilon_{F_0}$

$$\bar{\varepsilon}_0 = \frac{3}{5} \times 5.51 = 3.31 eV$$

The kinetic energy of a classical particle is

$$\frac{3}{2}kT$$

$$\text{So, } \frac{3}{2}kT = 3.31 eV = 3.31 \times 1.6 \times 10^{-19} J$$

On solving for T we get

$$T = \frac{2}{3} \times \frac{3.31 \times 1.6 \times 10^{-19}}{1.38 \times 10^{-23}} = 2.56 \times 10^4 K$$

Example 4: The Fermi energy of copper is 7eV. Calculate the average distance (mean free path) travelled by the conduction electrons between collisions. (conductivity of copper $6 \times 10^7 / \text{ohm m}$, concentration of valence electrons $8.5 \times 10^{28} / \text{m}^3$)

Sol: The velocity of electrons is given by $v_F = \sqrt{\frac{2\varepsilon_F}{m}}$, putting the given values you may get

$$v_F = 1.6 \times 10^6 m/s, \text{ Conductivity is given as } \sigma = \frac{ne^2 \lambda}{2mv_F} \text{ or } \lambda = \sigma 2mv_F / ne^2, \text{ putting the given}$$

values you may get $\lambda = 8 \times 10^{-8} m$

Example 5: What would be the mobility of electrons in copper if there are 9×10^{28} valence electrons per metre³ and the conductivity of copper is 6×10^7 mho/meter

Solution: conductivity of metal is given as $\sigma = ne\mu$ or $\mu = \frac{\sigma}{ne}$, putting the given values you may get $\mu = 4.16 \times 10^{-3} \text{ m}^2 / \text{Vs}$

Example6: Find the average drift velocity of electrons in copper conductor with a cross-sectional area of 10^{-6} m^2 carrying a current of 4×10^{-10} meter. The atomic weight of copper is 63.6 and the density is 8.9 gram/cm^3 . Avogadro's number $N_A = 6.02 \times 10^{23}$.

Solution: $\frac{N_A \rho}{M} = 8.42 \times 10^{28} \text{ atoms / m}^3$, you know the relation $j = nev_d$, therefore

$$v_d = \frac{j}{ne} = \frac{i}{neA} = 3.0 \times 10^{-4} \text{ m / s}$$

7.12 SUMMARY

In this unit, we have briefly reviewed classical kinetic theories of an electron gas both by Drude and by Lorentz as simple models of metals. The free electron model explains successfully some of the properties of solids, such as electrical and thermal conductivities etc. We have also reviewed electrical conductivity of metals in terms of electron collisions and mean free path. The Fermi energy is useful in determining the thermal and electrical characteristics of the solids. It is the very important concepts in the quantum mechanics and the superconductor physics. It is used to metal, insulators and semi-conductors. We learned that the Fermi Level is the highest energy level which an electron can occupy at the absolute zero temperature. Since at absolute zero temperature the electrons are all in the lowest energy state hence the Fermi level is in between the valence band and the conduction band. Free electrons are associated with a continuous energy spectrum and bound electrons with a discrete energy spectrum. Moreover, you have learned Fermi Dirac energy distribution among free electrons in metals. Now, we understand that at low temperature the electronic specific heat of solid is found to be predominant and varies linearly with T.

7.13 GLOSSARY

Assumption- supposition.

Randomly-arbitrarily.

Collision–accident.

Bouncing-Recoiling.

Trust-Belief.

Immobile-Steady.

Imperfection-deficiency.

Exclusion- rejection.

Mobility- flexibility.

Contribute-provide.

Residual-remaining.

7.14 REFERENCES

1. Charles Kittel, Introduction to Solid State Physics, Wiley Eastern Limited 5th ed. 1976
2. H. C. Gupta, Solid State Physics, Vikas Publishing House Private Limited 1995
3. A. J. Dekkar, Solid State Physics, The Macmillan Press Ltd. 1981

5.15 SUGGESTED READINGS

1. J. Callaway, Quantum Theory of the Solid State, Part A & B, Academic Press, New York (1974)
2. R. Kubo and T. Nagamiya, Solid State Physics, McGraw-Hill, New York (1969). 1992
3. Uichiro Mizutani, Introduction to the Electron Theory of Metals, Cambridge University Press, 2014.

7.16 TERMINAL QUESTIONS

1. What is the relation of electrical conductivity and the thermal conductivity agreeing to free electron theory?
2. What is Fermi energy?
3. What is the value of Fermi energy at absolute Zero?
4. What is the value of mean energy in terms of Fermi energy at absolute zero?
5. How does Fermi energy depends upon temperature?
6. How does electrical conductivity of a metal depends upon on temperature?
7. Write the relation of Fermi energy ε_F with Fermi temperature T_F
8. Why do metals have high electrical conductivity?
9. Why does metallic resistivity increase with rise in temperature?
10. What is Hall Effect?

True or False types questions

- (i) Fermi energy of a metal depends upon the size of the metal.
- (ii) Fermi energy does not change when two identical metals are joined together.
- (iii) Only electrons near the Fermi level contribute to the conductivity.
- (iv) Conductivity of metals increase with rise in temperature.
- (v) Pure metals have some residual resistivity at absolute zero temperature.
- (vi) Electron, proton and neutron are fermions.

Fill in the Blanks

- (i) In Quantum Physics, two or more identical particles are
- (ii) Fermions have.....spin.
- (iii) The highest energy level that can be occupied by an electron in a metal at 0K is called.....level.
- (iv) The maximum energy that a free electron in a metal can have at absolute zero is called....
- (v) The Fermi energy of a metal at 0 K temperatures depends on per unit volume in the metal.
- (vi) The ratio of Fermi energy to Fermi temperature equals to...
- (vii) In metals, the average distance covered by free electrons between collisions is called...

Numerical Problems

1. The electrical and thermal conductivities of silver at 20°C are 6.22×10^7 / ohm / meter and 423 W/m/K, respectively. Calculate the Lorentz number on the basis of free electron theory.
2. Calculate the heat capacity of electron gas at room temperature in copper assuming one free electron per atom. Compare this with the lattice specific heat value of 2.4×10^4 J/kmol/K. the Fermi energy of copper is 7eV.
3. A copper wire of cross sectional area 5×10^{-2} sq. cm. carries a steady current of 50 amperes. Assume one electron per atom; calculate the density of free electrons, the average drift velocity and the relaxation time. Given: the resistivity of copper 1.7×10^{-8} / ohm m.

Objective questions

- (i) The formula relating the thermal conductivity and electrical conductivity is
 - (a) $K / \sigma T = const$ (b) $K / \sigma T^2 = const$ (c) $\sigma / KT = const$ (d) $\sigma / KT^2 = const$
- (ii) Fermi level is.
 - (a) Lowest level filled with electrons
 - (b) Highest level containing electrons
 - (c) Sometimes
 - (d) Highest vacant level
- (iii) The drift speed of an electron in presence of an electric field E across a metal, having relaxation time τ is
 - (a) $eE / 2m$ (b) $e\tau E / 2m$ (c) $eE / 2m\tau$ (d) $2mE / e\tau$
- (iv) The current density in a metal in terms of drift speed and electron concentration per unit volume n is

- (a) ne / v_d (b) v_d / ne (c) nev_d (d) ev_d / n
 (v) The resistivity of a metal
 (a) Increases linearly with absolute temperature t at high temperatures
 (b) Decreases linearly with temperature T at high temperatures
 (c) is proportional to T^3 at high temperatures
 (d) is proportional to $T^{1/3}$ at high temperatures.

7.17 ANSWERS

Self-Assessment Question (SAQ):

1. Given: $l=0.5$ m, $d = 0.3$ mm, $r = 0.15 \times 10^{-3}$ m, $R = 0.12$ W, Lorentz Number =?

$$R = \rho \frac{l}{\pi r^2} = \frac{l}{\sigma \pi r^2}$$

$$\sigma = 5.89 \times 10^7 / \Omega m$$

$$L = \frac{K}{\sigma T} = \frac{390}{5.89 \times 10^7 \times 293}$$

$$L = 2.26 \times 10^{-8} W \Omega K^{-2}$$

2. The Fermi energy is given by $\epsilon_F = \frac{\hbar^2}{2m} \left(\frac{3\pi^2 N}{V} \right)^{2/3}$

First, we calculate electron density. Assuming one electron per sodium atom N/V is given by

$$\frac{N}{V} = \frac{N_A \rho}{W}$$

$$\frac{N}{V} = \frac{6 \times 10^{26} \times 0.97 \times 10^3}{23}$$

$$= 2.53 \times 10^{28} \text{ electrons} / m^3$$

$$\epsilon_F = \frac{\hbar^2}{2m} \left(\frac{3\pi^2 N}{V} \right)^{2/3} = 5.02 \times 10^{-19} \text{ joules}$$

$$\epsilon_F = 3.145 eV$$

3. Use the formula $\epsilon_F = \frac{\hbar^2}{2m} \left(\frac{3\pi^2 N}{V} \right)^{2/3}$

Here $N/V = 58.4 \times 10^{27} \text{ atoms} / m^3$

Putting these values in eq $\epsilon_F = \frac{\hbar^2}{2m} \left(\frac{3\pi^2 N}{V} \right)^{2/3}$

We get $\epsilon_F = 8.8 \times 10^{-19} J$

or, $\epsilon_F = 5.5 eV$

$$4. \quad \varepsilon_F = \frac{\hbar^2}{2m} \left(\frac{3\pi^2 N}{V} \right)^{2/3}$$

Here N is the number of conduction electrons in a volume V of lithium metal. The number of conduction electrons per unit volume is given as

$$N/V = 4.64 \times 10^{28} / m^3$$

Terminal Questions

1., $\frac{K}{\sigma T} = \text{Const}$, σ electrical conductivity and, K thermal conductivity

2. Fermi energy is the highest energy level containing electrons.

$$3. \quad \varepsilon_F = \frac{h^2}{8m} \left(\frac{3N}{\pi V} \right)^{2/3}$$

$$4. \quad \bar{\varepsilon}_0 = \frac{3}{5} \varepsilon_{F_0}$$

5. Fermi energy increases with increasing temperature.

6. On increasing temperature, the thermal agitation of electrons increases so electrons collide more frequently, thus leading to decrease in relaxation time consequently electrical conductivity decreases with increase in temperature.

7. $\varepsilon_F = kT_F$, where k is the Boltzmann constant.

8. Metals contain free electrons in abundance which is charge carriers.

9. The metallic resistivity is expressed as $\rho = \frac{2mv_F}{ne^2\lambda}$

As temperature increases, v_F increases and λ decreases, so ρ increases.

10. (i) F, (ii) T, (iii) T, (iv) F, (v) T, (vi) T

11. (i) indistinguishable (ii) half integral (iii) Fermi (iv) Fermi energy (v) Number of electrons (vi) Boltzmann constant k (vii) mean free path

Numerical Type questions

12. $2.32 \times 10^{-8} \text{ W ohm K}^{-2}$.

13. $146 \times 10^2 \text{ J kmol}^{-1} \text{ K}^{-1}$, 0.608 %.

14. $8.4 \times 10^{28} / m^3$, $7.4 \times 10^{-4} \text{ m/s}$, $2.46 \times 10^{-4} \text{ s}$.

Objective type

(i) a (ii) b (iii) b (iv) c (v) a

UNIT 8**BAND THEORY OF SOLIDS**

Structure

8.1 Introduction

8.2 Objectives

8.3 Bands and Band Gaps in solids

8.3.1 Valence Band

8.3.2 Conduction Band

8.3.3 Forbidden band

8.4 Classification of Solids on the Basis of Band Structure

8.4.1 Conductors

8.4.2 Semiconductors

8.4.3 Insulators

6.5 Bloch Theorem

6.6 Extended, Reduced and Periodic Zone Scheme

6.6.1 Extended Zone Scheme

6.6.2 Reduced Zone Scheme

6.6.3 Periodic zone Scheme

6.7 Behavior of an Electron in Periodic Potential

6.8 Theory of Band Structure in Solids (Kronig Penney Model)

6.9 Origin of Band Gap

6.10 Summary

6.11 Glossary

6.12 References

6.13 Suggested Reading

6.14 Terminal Questions

6.15 Answers

8.1 INTRODUCTION

The electronic band structure of a solid describes the range of energies that an electron within the solid may have, named as energy bands, allowed bands, or simply bands and ranges of energy that it may not have named as band gaps or forbidden bands. Band theory derives these bands and band gaps by examining the allowed quantum mechanical wave functions for an electron in a large, periodic lattice of atoms or molecules. Band theory has been successfully used to explain many physical properties of solids. In this division, the one-electron energy band theories for the crystalline solids are proposed. The significance of energy band theories for a crystalline solid is due to the fact that many important physical and optical properties of a solid can be described using its energy band structure. In broad, the energy band structure of a solid can be raised by solving the one-electron Schrödinger equation for electrons in a crystalline solid that contains a large number of interacting electrons and atoms. To simplify the complex work of solving the Schrödinger equation for the many-body problems in a crystal, the results that arise from the motion of atomic nuclei must be ignored; it is supposed that the nuclei are at rest in the equilibrium positions at each lattice site. In this unit, we shall study how the bands are formed and their classification on the basis of energy band gap. We shall use the concept of Bloch function to discuss the Kronig-Penney model for the behavior of an electron in periodic potential and describe how it leads to the origin of the energy bands and the forbidden bands in solids.

8.2 OBJECTIVES

After studying this unit, you should be able to-

- Define origin of energy bands.
- Apply the theory to classify bands.
- Understand Bloch function.
- Motion of an electron in one dimensional periodic potential.
- Kronig Penney Model and its consequences.
- Apply the theory to solve problems.

8.3 BANDS AND BAND GAPS IN SOLIDS

To understand the physics of energy band, consider a solid enclosing a huge number of atoms packed closely together. Each atom when isolated has a discrete set of electron energy levels $1s$, $2s$, $2p$, $3s$, $3p$ If we consider all the N atoms of the solids to be isolated from one another,

then they would have completely coinciding sets of energy levels. That is each of the energy levels of the N atoms system would have N fold degeneracy. They fill the energy levels in each atom independently. As the atom approach one another to form the solid, a continuous increasing interaction occurs between them which causes each of the levels to split into N distinct levels. In practice, N is very large, therefore the split energy levels become so numerous and so close together that they form an almost continuous energy band. The amount of splitting is different for different energy levels as shown in figure 8.1. In general, the lower levels are splitted less than the higher levels, the lowest levels remaining almost unsplit. The reason is that the electrons in the lower levels are the inner electrons of the atoms. which are not significantly influenced by the presence of nearby atoms. On the other hand, the electrons in the higher levels are the valence electrons whose wave functions overlap appreciably. The formation of energy levels for some of the higher energy levels of isolated sodium atoms are shown in figure. The $2p$ level does not split until the interatomic distance become smaller than actually found in the solid sodium, the level $1s$ and $2s$ do not split at all. The $3s$ level is the first occupied level to be splitted into a band. The energy bands in the solid correspond to energy levels in an atom. An electron in a solid can have only energies that fall within these energy bands. The various energy bands in solids may or may not be overlapping depending upon the structure of the solid. If they do not overlap then the intervals between them represents energies which the electrons in the solid cannot have. These intervals are called forbidden band gap or the energy band gap. If there is overlapping between the bands then they have the continuous distribution of allowed energies.

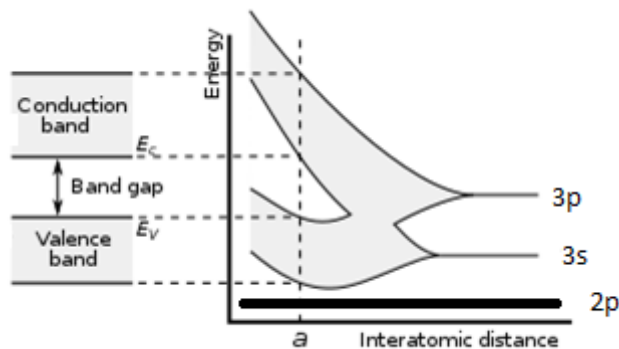

Figure 8.1: Splitting of Energy levels

In a single isolated atom, the electrons in each orbit have definite energy associated with it. But in case of solids all the atoms are close to each other, so the energy levels of outermost orbit electrons are affected by the neighbouring atoms.

When two single or isolated atoms are bringing close to each other than the outermost orbit electrons of two atoms are interact or shared with each other. i.e., the electrons in the outermost orbit of one atom experience an attractive force from the nearest or neighbouring atomic nucleus. Due to this the energies of the electrons will not be in same level; the energy levels of

electrons are changed to a value which is higher or lower than that of the original energy level of the electron. The electrons in same orbit exhibit different energy levels. The grouping of these different energy levels is called energy band. However, the energy levels of inner orbit electrons are not much affected by the presence of neighbouring atoms. There are number of energy bands in solids but three of them are very important as revealed in figure 8.2. These three energy bands are important to understand the behaviour of solids. These energy bands are

1. Valence Band
2. Conduction Band
3. Forbidden Band

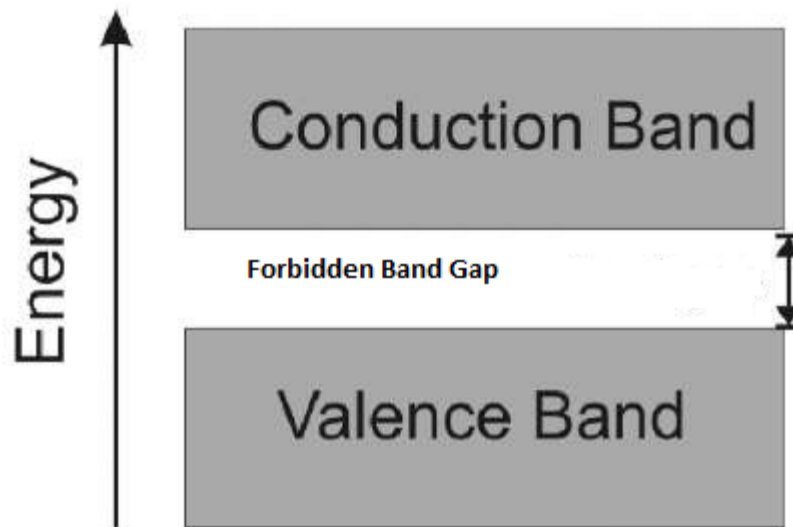

Figure 8.2: Classification of bands

8.3.1 Valence Band

The energy band which is formed by grouping the range of energy levels of the valence electrons or outermost orbit electrons is called as valence band. Valence band is present below the conduction band as shown in figure. Electrons in the valence band have lower energy than the electrons in conduction band. The electrons present in the valence band are loosely bound to the nucleus of atom.

8.3.2 Conduction Band

The energy band which is formed by grouping the range of energy levels of the free electrons is called as conduction band. Generally, the conduction band is empty but when external energy is

applied the electrons in the valence band jumps in to the conduction band and becomes free electrons. Electrons in the conduction band have higher energy than the electrons in valence band. The conduction band electrons are not bound to the nucleus of atom.

8.3.3 Forbidden Band

The energy gap which is present between the valence band and conduction band by separating these two energy bands is called as forbidden band or forbidden gap. In solids, electrons cannot stay in forbidden gap because there is no allowed energy state in this region. Forbidden gap is the major factor for responsible of electrical conductivity of a solid. The classification of materials as insulators, conductors and semiconductors are mainly depending on forbidden gap. The energy associated with forbidden band is called energy gap and it is measured in unit electron volt, eV ($1 \text{ eV} = 1.6 \times 10^{-19} \text{ J}$). The applied external energy in the form of heat or light must be equal to the forbidden gap in order to push an electron from valence band to the conduction band.

8.4 CLASSIFICATION OF SOLIDS ON THE BASIS OF BAND STRUCTURE:

The electrical properties of a solid depend upon its energy band structure. In common, each energy band has a total of N individual levels, and each level can hold $2(2l+1)$ electrons. In this way each band has $2(2l+1)N$ electrons. It means that the $1s, 2s, 2p, 3s, \dots$ bands can hold $2N, 2N, 6N, 2N, \dots$ electrons respectively. The classification of solids is based upon the nature of band occupation by electrons and the width of forbidden bands.

A useful way to visualize the difference between conductors, insulators and semiconductors is to plot the available energies for electrons in the materials as displayed in figure 8.3. Instead of having discrete energies as in the case of free atoms, the available energy states form bands. Crucial to the conduction process is whether or not there are electrons in the conduction band. In insulators the electrons in the valence band are separated by a large gap from the conduction band, in conductors like metals the valence band overlaps the conduction band, and in semiconductors there is a small enough gap between the valence and conduction bands that thermal or other excitations can bridge the gap. With such a small gap, the presence of a small percentage of a doping material can increase conductivity dramatically. An important parameter in the band theory is the Fermi level, the top of the available electron energy levels at low temperatures. The position of the Fermi level with the relation to the conduction band is a crucial factor in determining electrical properties.

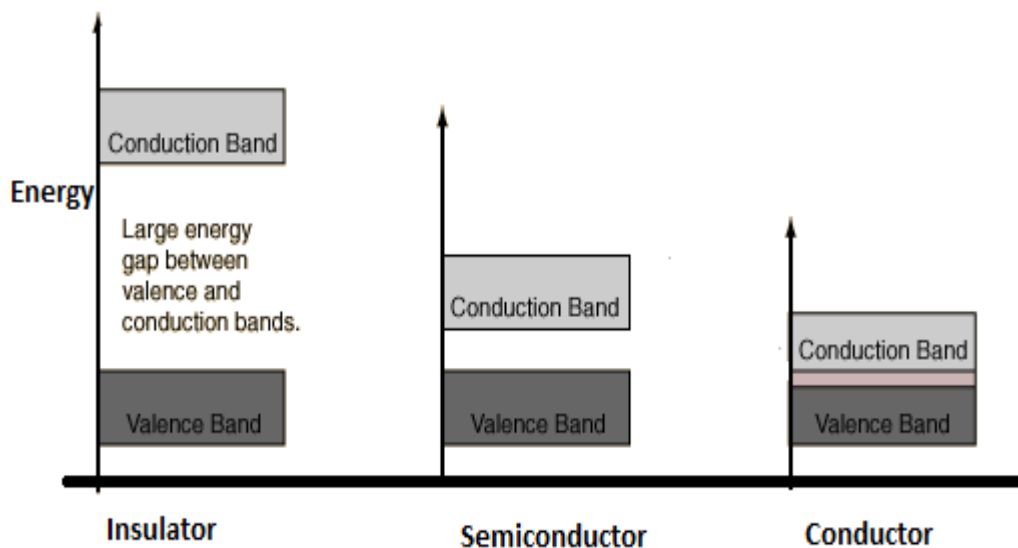

Figure 8.3: Comparative study of insulator, semiconductor and conductor

8.4.1 Conductors

In some solids, there is partially filled band above the completely filled lower bands. Such a band is formed from partially filled atomic levels as in case of Sodium. A sodium atom has a single valence electron in its outer 3s level. Therefore, out of N atoms in a solid material of sodium, each contributes only one 3s electron to the solid, and so there are only N valence electrons in the 3s band. Thus the balance band 3s is only half full. A partially filled band may also be the result of overlapping of a completely filled band and an empty band, as in case of alkaline earth metals. As shown in figure the energy band of beryllium in which there is an overlap of the lower energy levels of the empty 2p band with the upper energy levels of the completed 2s band. Those electrons which would occupy the highest energy levels in the 2s band will actually go into the lowest levels of the overlapping 2p band. Thus, levels of the top of 2s band become unoccupied and the band is only partially filled.

When an electric field is applied across a piece of solid sodium, the electrons in the partially filled valence band easily acquire additional energy to move to the higher unoccupied energy levels within the same band as depicted in figure 6.4, without crossing the energy gap. Thus, a partially filled valence band is a feature of conductors. As we know a conduction band is an empty band just above the valence band into which electrons can pass. So, in conductors the balance band itself is a conduction band.

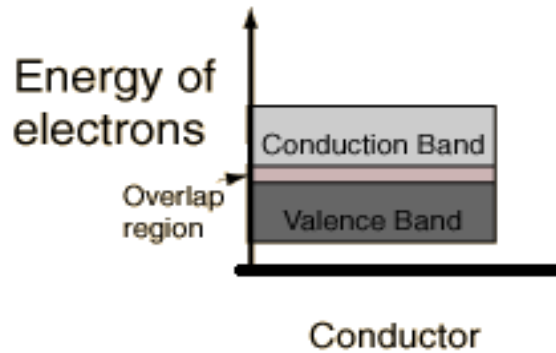

Figure 8.4: Overlapping of bands in conductor

8.4.2 Semiconductor

In semiconductor as shown in figure 6.5, the band gap is small enough that the thermal energy can bridge the gap for the small fraction of the electrons.

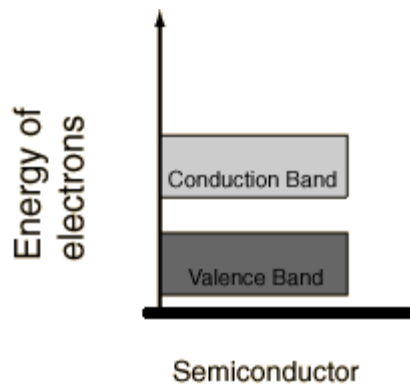

Figure 8.5: Band gap in semiconductor

For intrinsic semiconductors like silicon and germanium, the Fermi level is essentially halfway between the valence and conduction bands. Although no conduction occurs at 0 K, at higher temperatures a finite number of electrons can reach the conduction band and provide some current. In doped semiconductors, extra energy levels are added. The increase in conductivity with temperature can be modelled in terms of the Fermi function, which allows one to calculate the population of the conduction band. However, the doping of semiconductors has a much more dramatic effect on their electrical conductivity and is the basis for solid state electronics.

8.4.3 Insulator

In insulators, there is a big gap between valence band and conduction band. Figure 6.6 shows the energy bands of diamond. There is an energy band completely filled with electrons and above is the empty band separated by a gap of around 7 eV. At least 7eV of energy must be supplied to an electron in order to reach the conduction band where it can move freely.

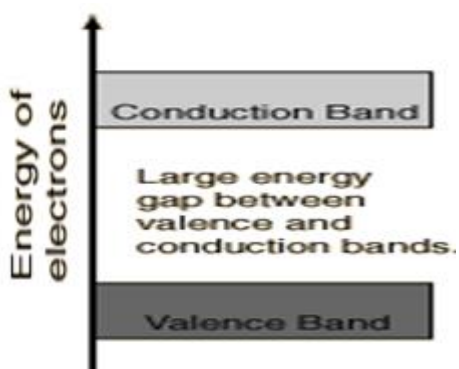

Figure 8.6: Band gap in insulator

Most solid substances are insulators, and in terms of the band theory of solids this implies that there is a large forbidden gap between the energies of the valence electrons and the energy at which the electrons can move freely through the material (the conduction band). Glass is an insulating material which may be transparent to visible light for reasons closely correlated with its nature as an electrical insulator. The visible light photons do not have enough quantum energy to bridge the band gap and get the electrons up to an available energy level in the conduction band. The visible properties of glass can also give some insight into the effects of doping on the properties of solids. A very small percentage of impurity atoms in the glass can give it colour by providing specific available energy levels which absorb certain colours of visible light. The ruby mineral (corundum) is aluminium oxide with a small amount (about 0.05%) of chromium which gives it its characteristic pink or red colour by absorbing green and blue light. While the doping of insulators can dramatically change their optical properties, it is not enough to overcome the large band gap to make them good conductors of electricity.

8.5 NEARLY FREE ELECTRON MODEL

As we discussed earlier, in free electron model the allowed energy for the electrons are distributed continuous from zero to infinity depending on wave vector and given as

$$\varepsilon = \frac{\hbar^2}{2m} k^2 = \frac{\hbar^2}{2m} (k_x^2 + k_y^2 + k_z^2)$$

The boundary condition for a cubic crystal can be given as

$$k_x, k_y, k_z = 0, \pm \frac{2\pi}{L}, \pm \frac{4\pi}{L} + \dots$$

Schrodinger wave equation for free electron gas can be given as

$$\frac{d^2\psi_n}{dx^2} + k^2 \psi_n = 0 \quad \text{where} \quad \frac{2m\varepsilon_n}{\hbar^2} = k^2$$

This is standard differential equation. The wave function for the free electron can be given as

$$\psi_n(\mathbf{r}) = e^{i\mathbf{k}\cdot\mathbf{r}}$$

The band formation in solids cannot be explained by free electron model because the energy is continuous. The band formation of solids is often explained by free electron model. In this model, it is assumed that the electrons are perturbed weakly by the periodic potential of ion core of solid. The Bragg reflection of electron wave at zone boundaries causes the band gap. At these points, the solution of above equation does not exist and the energy pattern is break as shown in figure 8.. In figure 8.a an energy is shown for free electron model. In figure 8 b, is for nearly free electron model with energy gaps at $\pm \frac{n\pi}{a}$. The Bragg condition for diffraction at these point is $(k + G)^2 = K^2$ where symbols have usual meaning. The first Bragg reflection and first energy gap occurs at first Brillouin zone. Thus we explain the origin of band gap with this model.

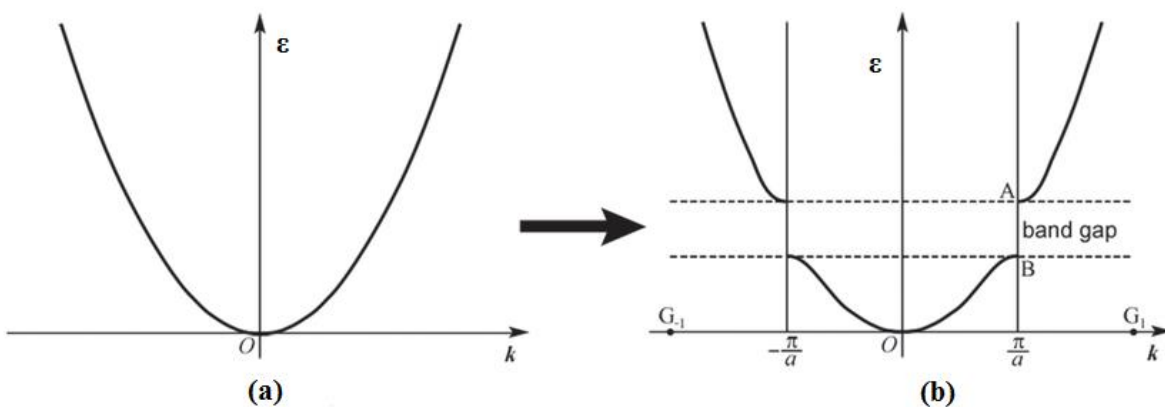

Figure 8.7: Energy variation and formation of band gap for free electron (a) and nearly free electron (b)

8.6 BLOCH THEOREM

A periodic potential appears because the ions are arranged with a periodicity of their Bravais lattice, given by lattice vectors a .

$$V(x + a) = V(x)$$

The Bloch theorem is a mathematical statement regarding the form of the solutions of the Schrodinger equation of an electron moving in a region of periodic potential, such as crystal lattice. It states that the eigenfunction of the electronic Schrodinger equation for a periodic potential are of the form $\psi(\vec{r}) = e^{i\vec{k}\cdot\vec{r}} u_k(\vec{r})$, where the function $u_k(\vec{r})$ has the period of the crystal lattice and \vec{k} is the wave vector. This is the statement of Bloch theorem which means that the eigenfunctions of the wave equation for a periodic potential are of the form of plane waves $e^{i\vec{k}\cdot\vec{r}}$, modulated by a function $u_k(\vec{r})$ with the periodicity of the crystal lattice.

8.6.1 Extended, Reduced and Periodic Zone Scheme

In Bloch function, $\psi(\vec{r}) = e^{i\vec{k}\cdot\vec{r}} u_k(\vec{r})$, we have labeled the modulating factor $u_k(\vec{r})$ by a subscript \vec{k} to indicate that the form of this factor depends on the wave vector \vec{k} . There are three ways called zone schemes to states in different energy bands.

8.6.2 Extended Zone Scheme

Different energy bands are drawn in different Brillouin zones in the wave vector space.

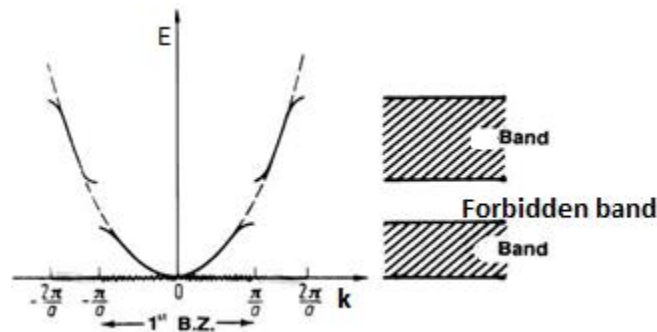

Figure 8.8: Energy versus wave vector in extended zone scheme

Three energy bands of a linear lattice have shown in figure 8.8 for the first three Brillouin zones. The first zone is the region of k space within the first energy gap; the second zone is the region between the first and the second energy gap and so on.

8.6.3 Reduced Zone Scheme

The representation using $E_k = \frac{\hbar^2 k^2}{2m}$ shows all bands in the first Brillouin zone only and is known as the **reduced zone scheme**.

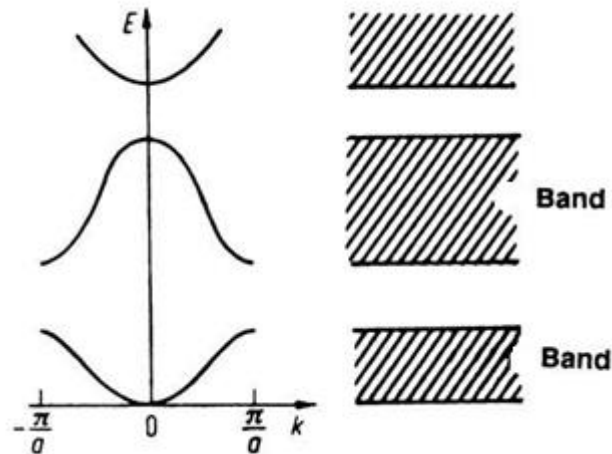

Figure 8.9: Energy versus wave vector in reduced zone scheme

8.6.4 Periodic zone Scheme

In this pattern, energy band is drawn in every zone as shown in figure 6.9. We repeat a given Brillouin zone periodically through whole of k space. If we translate a band from other zones into the first zone, then we can translate a band in the first zone into every other zone. Therefore, in this pattern the energy E of the band is a periodic function in the reciprocal lattice.

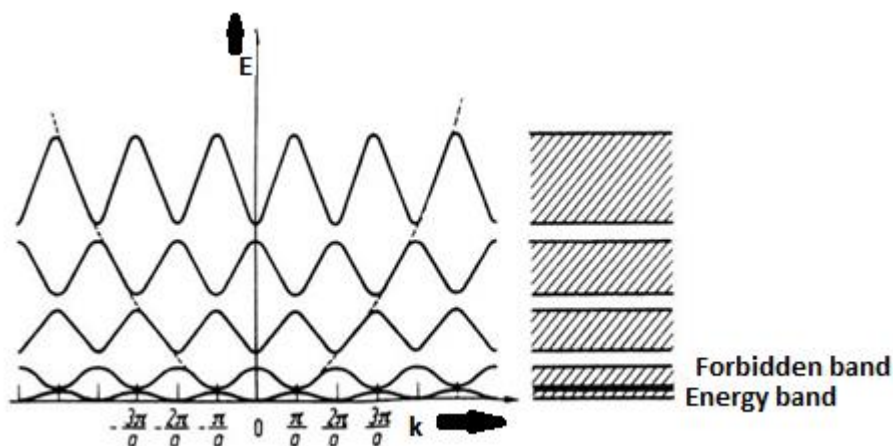

Figure 8.10: Energy versus wave vector in periodic zone scheme

8.7 BEHAVIOR OF AN ELECTRON IN PERIODIC POTENTIAL

The free electron model of metals assumes the conduction electrons to move freely in a region of constant potential without interacting with the crystal lattice. Although this model explains certain properties of metals, such as conductivity, specific heat, Para magnetism etc., but it fails to explain satisfactorily properties of solids in general. Hence it needs to be modified.

In general, an electron in solid moves in a region of periodically varying potential caused by the ion cores situated at the lattice points.

8.8 KRONIG PENNEY MODEL

Kronig and Penney assumed that an electron experiences an infinite one dimensional array of finite potential well. Each potential well model attraction to an atom in the lattice, so the side of the wells must correspond roughly to the lattice spacing as exposed in figure 6.10.

In order to find the allowed energies of electrons in solids, we must solve the Schrodinger equation for an electron in a crystal lattice. The figure shows the actual potential as seen by the electron in the crystal lattice in one dimension. Kronig-Penney suggested a simplified model potential consisting of an infinite row of rectangular potential wells separated by barriers of width b , with space periodicity a is the periodicity of the lattice. The solution to the Schrodinger equation for an electron in a periodic lattice can be found by Bloch theorem. According to this, the eigenfunction of the free electron travelling wave $\psi_k(x) = e^{ikx}$ is modified by the periodic potential to be of the form $\psi_k(x) = u_k(x)e^{ikx}$.

Where $u_k(x) = u_k(x+a)$

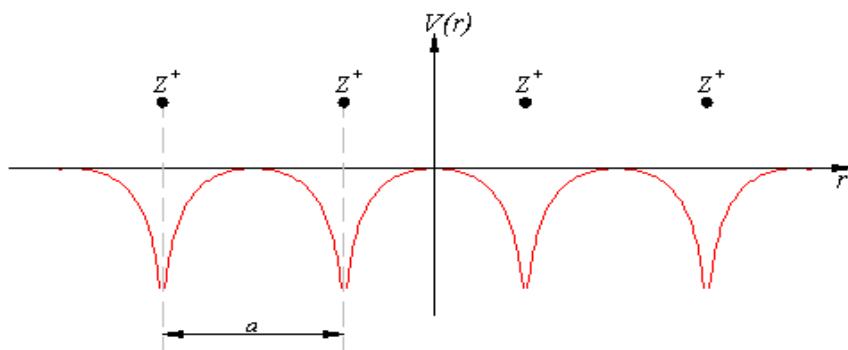

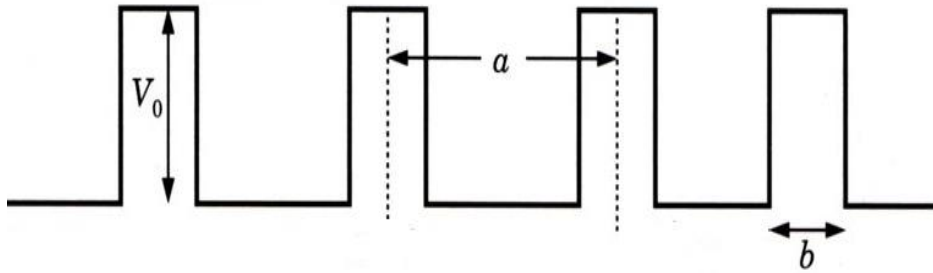

Figure 8.11: Kronig and Penney square well potential

On solving Schrodinger equation of the electron for the Kronig-Penney potential under the condition that ψ and $d\psi/dx$ must be continuous at the boundaries of the well, a complicated expression for the allowed energies in terms of k of the electron is obtained which shows that the gap in the energy occur at values given by

$$k = \pm \frac{\pi}{a}, \pm \frac{2\pi}{a}, \pm \frac{3\pi}{a}, \dots$$

Figure 8.12 shows the relationship between energy ε and wave number k for a one-dimensional lattice. The dashed curve is the free electron parabola.

At the above value of k we get energy gap, whereas for values of k not near these values the energy are much like that of free electron. The origin of the allowed energy bands and forbidden gaps are seen in figure.

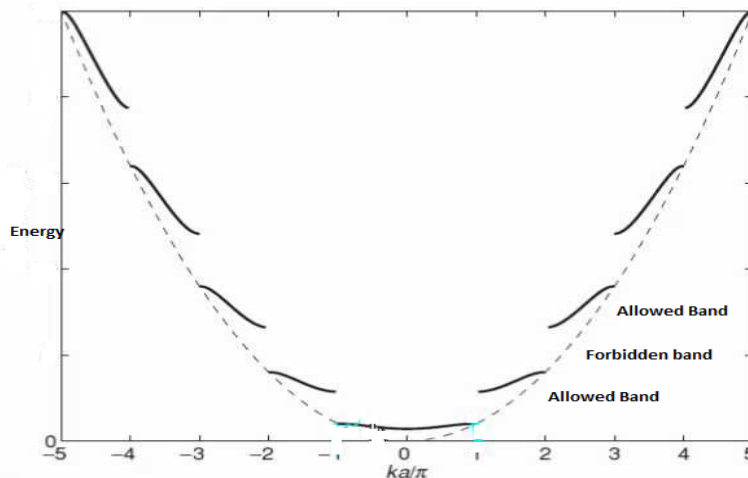

Figure 8.12: Allowed and forbidden bands

The occurrence of gaps can be understood in terms of Bragg reflection. The Bragg's condition is

$$2a \sin \theta = n\lambda$$

Where a is the spacing between the ions of the lattice. Since we are considering the lattice in one dimension only, the above equation becomes

$$2a = n\lambda$$

$$\text{or } 2a = n\lambda 2\pi / 2\pi$$

$$\text{or, } k = n \frac{\pi}{a} = \pm \frac{\pi}{a}, \pm \frac{2\pi}{a}, \pm \frac{3\pi}{a}, \dots$$

These are just the values of k at which the gaps in the $\epsilon - k$ curve occur. The waves corresponding to values of k not satisfying the above condition travel almost freely and those satisfying the condition are reflected resulting in standing waves.

8.9 ORIGIN OF BAND GAP

The wave function associated with Kronig-Penney model may be calculated on solving Schrodinger wave equation in two sections.

$$\text{We have } \frac{d^2\psi}{dx^2} + \frac{8\pi^2m}{h^2} E\psi = 0 \text{ for } 0 < x < a$$

$$\text{or we can write } \frac{d^2\psi}{dx^2} + \alpha^2\psi = 0$$

$$\text{Where the value of } \alpha^2 = \frac{8\pi^2mE}{h^2}$$

$$\text{Also, } \frac{d^2\psi}{dx^2} + \frac{8\pi^2m}{h^2} (E - V_0)\psi = 0 \text{ for } -b < x < a$$

$$\text{or we can write } \frac{d^2\psi}{dx^2} - \beta^2\psi = 0$$

$$\text{Where } \beta^2 = \frac{8\pi^2m}{h^2} (V_0 - E)$$

Expected solutions of these Schrodinger equations should have the form of Bloch function, which requires that ψ and $d\psi/dx$ to be continuous throughout the crystal. Let us consider the general solutions of these Schrodinger equations

$$\psi_1(x) = A \exp(i\alpha x) + B \exp(-i\alpha x)$$

And $\psi_2(x) = C \exp(\beta x) + D \exp(-\beta x)$

Here, A, B, C, and D are the constant in region I and II. Values of these constant can be obtained using the boundary conditions as

$$\psi_1(x)|_0 = \psi_2(x)|_0$$

$$d\psi_1 / dx|_{x=0} = d\psi_2 / dx|_{x=0}$$

$$\text{And } \psi_1(x)|_{x=0} = \psi_2(x)|_{x=-b}$$

Because for the periodic lattice that is $V(x+a) = V(x)$, it is supposed that the wavefunction will also show the same periodicity. Hence, the expected solution of the above said Schrodinger equation must have the same form as that of the Bloch function.

So, we can write

$$\psi_k(x+a+b) = \psi_k(x) \exp(ik(a+b))$$

$$\psi_k(x) = \psi_k(x+a+b) \exp(-ik(a+b))$$

Now applying the boundary conditions, we get the following relations

$$A+B = C+D$$

$$i\alpha(A-B) = \beta(C-D)$$

On simplifying these equation one can get

$$\cos k(a+b) = \left[\frac{\beta^2 - \alpha^2}{2\alpha\beta} \right] \sin \alpha a \sinh \beta b + \cos \alpha a \cosh \beta b$$

To solve above equation, Kronig-Penney supposed that the potential energy is zero at lattice sites and equal V_0 in side. Also assumed that, as the height of the potential barrier V tends to infinity and the width of the barrier b tends to zero so that the product $V_0 b$ remains finite. Under these assumptions

$$\sinh \beta b \rightarrow \beta b$$

$$\cosh \beta b \rightarrow 1 \text{ as } b \rightarrow 0$$

Therefore

$$\cos ka = \left[\frac{\beta^2 - \alpha^2}{2\alpha\beta} \right] \beta b \sin \alpha a + \cos \alpha a$$

Hence on solving we get

$$\cos ka = \left[\frac{8\pi^2 m}{2\alpha\beta h^2} \right] V_0 \beta b \sin \alpha a + \cos \alpha a$$

$$\text{or, } \cos ka = P \sin \alpha a / \alpha a + \cos \alpha a$$

$$\text{Where } P = \left[\frac{4\pi^2 m a}{h^2} \right] V_0 b$$

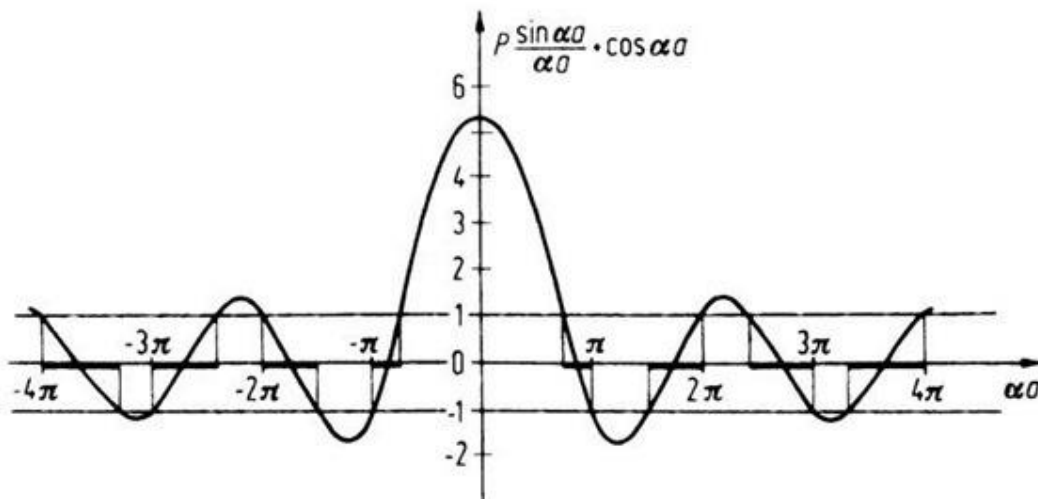

Figure 8.13: Origin of band gap

This is the condition for the solutions of the wave equation to exist. As you see from figure 8.13 that this is satisfied only for those value of αa for which its left-hand side lies between +1 and -1. It is because its right hand side must lie in range. Such values of αa represent the wave like solution and are reachable. On the other hand, the other values of αa will be inaccessible. The significances of this can be agreed very well by the figure. The part of vertical axis lying between the horizontal lines represents the range acceptable. Since α^2 is proportional to the energy so αa will be measure of energy. It is clear that the region for αa where the value of $P \sin \alpha a / \alpha a + \cos \alpha a$ does not lie between -1 and +1. Therefore, these values of αa and henceforth of energy E , there is no solution. Such region of energy is disallowed and is named forbidden bands. This analysis led to the following inferences

1. The energy spectrum of the electron consists of alternate regions of allowed energy that is continuous band and forbidden energy band. Usually these bands are referred as allowed and forbidden energy bands.

2. As the value of αa increases the width of the allowed energy bands increases.
3. The quantity P , which is noted as a measure of potential barrier strength. If P is large, means the potential barrier $V_0 b$ is large. For the infinite deep well the electron can be considered as confined into a single potential well. It is applied to the crystals where the electrons are very tightly bound with their nuclei. In second case, when P is small, the barrier strength is small that is $P \rightarrow 0$, the electron can be considered to be moving freely through the potential well. It is the case of crystal where the electron is almost free of their nuclei. Hence we conclude that the width of particular allowed band decreases as P increases. As $P \rightarrow \infty$, the allowed bands are compressed into energy levels and the energy spectrum is thus a line spectrum. Whereas $P \rightarrow 0$, we have the free electron model of the energy spectrum. It is known as quasi continuous. In between these limits, the position and the width of the allowed and forbidden bands for any value of P are obtained.
4. To calculate the energy spectrum in extreme cases ($P \rightarrow \infty$), we have

$$\alpha a = n\pi$$

or we can write $\frac{2mE}{\hbar^2} a^2 = n^2 \pi^2$

or you can write, $E = \frac{\pi^2 \hbar^2}{2ma^2} n^2$

It is the physically expected result because the large P makes the tunneling through the barrier nearly unlikely. In second case when $P \rightarrow 0$

We get $\cos \alpha a = \cos ka$

Which implies $\alpha = k$

or, $\alpha^2 = k^2$

Which gives $E = \frac{\hbar^2 k^2}{2m}$, this is equivalent to the case of free particle. Thus no allowed energy level exists.

8.9.1 Effective Mass

If an electric field is applied to a free electron the electrostatic field experienced by electron is given by

$$F = -eE = ma$$

If external force is applied to electron the mass of the electron is proportional to the ratio of force and acceleration ($m=F/a$). This mass is called free mass or actual rest mass. But in case of solids, due to periodic potential due to ion core, the acceleration of the electron is different. This interaction of ion core results the mass of electron is different than the actual mass of electron and this mass is called effective mass m^* . The equation of motion is given as

$$m^* a = (m - m') = -eE/a$$

In case of lattice, the energy of free electron is given as

$$E = \frac{\hbar^2 k^2}{2m}$$

Differentiate this equation 2 times with respect to k

$$\frac{d^2 E}{dk^2} = \frac{\hbar^2}{m}$$

$$m = \frac{\hbar^2}{\left(\frac{d^2 E}{dk^2}\right)}$$

If the free electrons of solid is moving in a periodic potential the mass is call effective mass and given as

$$m^* = \frac{\hbar^2}{\left(\frac{d^2 E}{dk^2}\right)}$$

The value of effective mass may be more and less than the actual mass of electron $m_e = 9.1 \times 10^{-31} \text{ kg}$.

Example 1: Show that for the Kronig-Penney potential with $P \leq 1$, the energy of the lowest

energy band at $k=0$ is given by $E = \frac{h^2 P}{4\pi^2 m a^2}$

Solution: for $k=0$ $P \sin \alpha a / \alpha a + \cos \alpha a = \cos ka$ becomes

$$P \sin \alpha a / \alpha a + \cos \alpha a = 1$$

or we may write

$$P / \alpha a = 1 - \cos \alpha a / \sin \alpha a$$

On expanding sine and cosine function

$$\text{where } \cos \alpha a = 1 - \frac{\alpha^2 a^2}{2}$$

$$\text{And } \sin \alpha a = \alpha a$$

$$\text{so, we can write } P / \alpha a = \frac{\alpha^2 a^2}{2}$$

$$\text{we know } \frac{8\pi^2 m E}{h^2} = \alpha^2$$

$$\text{hence, we get } P = \frac{8\pi^2 m E}{h^2} (a^2 / 2)^2$$

$$\text{or } E = \frac{h^2 P}{4\pi^2 m a^2}$$

Example 2: In germanium the energy gap is about 0.75 eV. Show that the crystal behaves as a transparent medium only for light of wavelength above 16533 Å. (given $h = 6.63 \times 10^{-34}$ J s, vel of light $c = 3.0 \times 10^8$ m/s)

Solution: first we calculate the energy of 16533 Å photon

$$E = hc / \lambda$$

On putting the values, we get

$$E = hc / \lambda = \frac{6.63 \times 10^{-34} \times 3.0 \times 10^8}{16533 \times 10^{-10}}$$

$$= 1.2 \times 10^{-19} \text{ Joule}$$

$$\text{or} = 1.2 \times 10^{-19} \text{ Joule} / 1.6 \times 10^{-19} = 0.75 \text{ eV}$$

Since the photon energy for light of wavelength above 16533 Å will be less than 0.75 eV which is energy band gap in case of germanium. Therefore, these photons will not be absorbed and the light will be transmitted through the crystal. Those photons for light below 16533 Å will have energy more than the energy gap of 0.75 eV and so they will be absorbed in exciting the electrons from the valence band to the conduction band. So, the crystal is opaque for the light below 16533 Å.

Example 3: The energy gap in silicon is 1.1eV and in diamond it is 6eV. State the transparency of these substances to visible light.

Solution: the wavelength of light corresponding to photon energies 1.1 eV

$$E = hc / \lambda = \frac{6.63 \times 10^{-34} \times 3.0 \times 10^8}{1.1 \times 1.6 \times 10^{-19}}$$

$$= 11.3 \times 10^{-7} \text{ m}$$

$$= 11300 \text{ Å}$$

And for 6 eV

$$E = hc / \lambda = \frac{6.63 \times 10^{-34} \times 3.0 \times 10^8}{6 \times 1.6 \times 10^{-19}}$$

$$= 2072 \text{ Å}$$

So, we conclude the silicon is transparent only to radiation of $\lambda \geq 11300$ Å. Because, it absorbs photons of shorter wavelength, and so it is opaque to visible light. Since diamond is transparent to radiation of $\lambda \geq 2072$ Å, therefore it is transparent to visible light.

8.10 SUMMARY

In this unit, you have studied about the origin of the energy band theory in solids. The large energy gap between the valence band and conduction bands in an insulator says that at ordinary temperature, no electron can reach the conduction band. It is discussed that, in semiconductor the band gap is small enough that the thermal energy can bridge the gap for the small fraction of the electrons. In, conductors, there is no band gap since the valence band overlap the conduction band. Making use of the Bloch theorem and the Kronig-Penney model, the energy spectrum of the electron is found to comprise a set of continuous band, separated by the region of forbidden energies which are called energy gaps. This can be understood from the construction of Brillouin

zones. The first Brillouin zone is defined as the region in k space. The energy levels of an electron in a crystal can be determined by solving Schrödinger's equation for a periodic potential and by studying changes to the electron energy structure as atoms are pushed together from a distance. The energy structure of a crystal is characterized by continuous energy bands and energy gaps. The ability of a solid to conduct electricity depends on the energy structure of the solid. In solids, the discrete energy levels of the individual atoms merge to form energy bands. Energy gaps arise in solids because they contain standing wave states. The size of the energy gap between the valence and conduction bands determines whether a substance is a conductor, an insulator or a semiconductor. To check your progress, examples and terminal questions are given.

8.11 GLOSSARY

extended – extensive.

Periodic- cyclic.

Forbidden – prohibited.

Contribute– provide.

Crucial– critical.

Doping– fixing.

Dramatically–noticeably.

Translate– interpret.

Assumption– supposition.

Accessible– reachable.

Transmit– convey.

Discrete - isolated.

8.12 REFERENCES

1. Charles Kittel, Introduction to Solid State Physics, Wiley Eastern Limited 5th ed. 1976
2. H. C. Gupta, Solid State Physics, Vikas Publishing House Private Limited 1995
3. A. J. Dekkar, Solid State Physics, The Macmillan Press Ltd. 1981
4. C.M. Kachhava, Solid State Physics, Tata McGraw-Hill Publishing Company Limited
5. S L Kakani, C Hemarajani, Solid State Physics, Sultan Chand and Sons, New Delhi
6. J. Callaway, Energy Band Theory, Academic Press, New York (1964).
7. J. Callaway, Quantum Theory of the Solid State, Part A & B, Academic Press, New York
8. R. Kubo and T. Nagamiya, Solid State Physics, McGraw-Hill, New York (1969). 1992

8.13 SUGGESTED READING

1. J M Jiman, Principal of the theory of solids, Cambridge University Press.
2. D. Greig, electrons in metals and semiconductors, McGraw-Hill, London

3. M A Wahab, Solid State Physics (Structure and properties of Materials), Alpha Science International Ltd. U.K.

8.14 TERMINAL QUESTIONS

1. How does the electrical conductivity of a pure semiconductor change with rise in temperature?
2. Why does the electrical conductivity of a pure semiconductor increase on heating?
3. Name the charge carriers at room temperature in a conductor, an intrinsic semiconductor and an insulator.
4. 16. The energy gaps in the energy band diagram of a conductor, an insulator and a semiconductor are E_1 , E_2 and E_3 , arrange them in increasing order.
5. Describe in what sense an insulator with infinite band gap cannot be a perfect insulator.
6. Calculate the energy gap of a crystal which is transparent only for light of wavelength greater than 12345 \AA .
7. An insulator has an optical absorption only for wavelengths shorter than 1800 \AA . Find the width of the forbidden band for the insulator. What is the order of magnitude of the forbidden gap in a semiconductor?
8. The energy gaps of Si, Ge and Ag are 1.1, 0.7 and 0 eV respectively. Find the wavelength of electromagnetic radiation to which these solids are opaque. (given $h = 6.63 \times 10^{-34} \text{ J s}$, vel of light $c = 3.0 \times 10^8 \text{ m/s}$)
9. What are the two main approaches used to determine the energy levels of electrons in a crystal?
10. How does the number of energy levels in a band correspond to the number N of atoms?
11. What is the main difference between an insulator and a semiconductor?
12. A valence electron in a crystal absorbs a photon of wavelength, $\lambda = 0.300 \text{ nm}$, this is just enough energy to allow the electron to jump from the valence band to the conduction band. What is the size of the energy gap?
13. In a band theory of solids, there are an infinite number of bands. If $T = 0 \text{ K}$, the uppermost band to contain electrons is partially filled, and the gap between the band and the next lowest band is 0.8 eV, is the material a metal, an insulator, or a semiconductor.
14. In a band theory of solids, there are an infinite number of bands. If $T = 0 \text{ K}$, the uppermost band to contain electrons is completely filled and the gap between the band and the next lowest band is 8 eV, is the material a metal, an insulator, or a semiconductor? What if the gap is 0.8 eV?
15. **True/ False statements**
 - (a) When the large number of atoms is brought close together, the energy levels split and form energy band.
 - (b) The conduction band of an insulator is empty.
 - (c) The forbidden energy band in Si is 1.1 eV.
 - (d) The conduction band of a conductor is empty.
 - (e) Insulators are opaque to visible light.

- (f) All one electron configurations in an ideal crystal are Bloch functions.
- (g) Conductivity of semiconductors decreases with rise in temperature.
- (h) At temperature near absolute zero, the semiconductors become insulators.
- (i) Kronig-Penny model explains the behaviour of an electron in non-uniform magnetic field.

16. **Fill in the Blanks**

- (a) Conductors havevalence energy band.
- (b) The motion of electron in the periodic crystal lattice gives rise to
- (c) The band energy of solids deals with electron motion in thefield of crystal.
- (d) In metals, there is an overlapping ofand.....bands.
- (e) The energy gap for a semiconductor is.....than for an insulator.
- (f) A solid having a band completely filled and the next allowed band completely empty is called.....
- (g) Insulators are transparent tolight.
- (h) Kronig-Penny model explain the behaviour of an electron moving in a periodically varying.....
- (i) Semiconductors are opaque to visible light but transparent to

8.15 ANSWERS

2. Around absolute zero, a pure semiconductor is an insulator because the valence band is full and there are no free electrons in the conduction band. As the temperature rises, more and more of the electrons in the valence band gain energy to cross the energy gap and enter the conduction band, hence the conductivity increases.
3. Free electrons, free electrons and holes, no charge carriers.
4. $E_1 < E_2 < E_3$.
5. As long as band gap is finite, an electron can be elevated to the conduction band, resulting in conduction
6. 1.0 eV
7. 6.9 eV
8. For Si, $\lambda = 0-11300 \text{ \AA}$, For Ge, $\lambda = 0-17760 \text{ \AA}$, For Ag, $\lambda = 0- \infty \text{ \AA}$
9. (1). Solve Schrödinger's equation for the allowed states and energies. (2) Determine energy levels for the case of very large lattice spacing and then determine the energy levels as this spacing is reduced.
10. For N atoms spaced far apart, there are N different wave functions, all with the same energy (similar to the case of an electron in the double well of H₂).
As the atoms are pushed together, the energies of these N different wave functions are split. By the exclusion principle, each electron must each have a unique set of quantum numbers, so the N atoms bringing N electrons together must have at least N states.
11. For an insulator, the energy gap between the valence band and the conduction band is larger than for a semiconductor.

12. 4.13 keV.

13. Metal.

14. Insulator, semiconductor.

15. (a) T, (b) T, (c) T, (d) F, (e) F, (f) T, (g) F, (h) T, (i) F.

16. (a) partially filled, (b) energy gap, (c) periodic, (d) valence, conduction, (e) smaller (f) insulator (g) visible

UNIT 9**SEMICONDUCTOR CRYSTALS**

Structure

9.1 Introduction

9.2 Objectives

9.3 Semiconductors

9.4 Types of Semiconductors

9.4.1 Intrinsic semiconductors

9.4.2 Extrinsic semiconductors

9.5 Band Gap

9.6. Equation of motion electron in band

9.7. Effective Mass of an Electron

9.8 intrinsic carrier concentrations in semiconductor

9.8.1. Fermi energy

9.9 Extrinsic carrier concentrations in semiconductor

9.9.1 n-type semiconductor

9.9.2 p-type semiconductor

9.10 Drift Current

9.11. Mobility and conductivity

9.12 Thermoelectric effect

9.13 Summary

9.14 Glossary

9.15 References

9.16 Suggested Readings

9.17 Terminal Questions

9.18 Answers

9.1 INTRODUCTION

Semiconductors are generally classified as the materials which have electric resistivity at room at the order of 10^{-4} ohm-m. The resistivity of semiconductors strongly depends on temperature. As temperature increases the resistivity decreases. At absolute zero temperature all the semiconductors become insulators. On the basis of electrical properties, solids can be classified as conductors, semiconductor and insulators. Conductors are those across which electric charge can flow very easily. While insulators are those through which, there is no electric charge or difficult to flow the charge. In conductors, there are large numbers of free charge carriers while insulators have nearly no free charge carriers. Semiconductors have very few thermally generated charge carriers and electrical conductivity is intermediate between conductors and insulators. All semiconductors have crystalline structure and the most commonly used semiconductors are Ge, Si and GaAs as they have application in electronics. The number of free electrons in semiconductors is at the order of 10^7 to 10^{28} electron/m³. The variation of carrier concentration with temperature is shown in figure 9.1. In conductors, the electrical resistance increases with rise in temperature meaning that the temperature coefficient of resistance is positive. The outermost valence shell electrons of semiconductors are neither so tightly bound with the atom as in insulator, nor so loosely bound as in case of conductors. Semiconductor has electric conductivity much greater than that insulator but much smaller than metals. The electrical resistance of semiconductors decreases with the increase in temperature that is why, the temperature coefficient of semiconductors is negative. In terms of band gap, solids have a much smaller energy gap that is of the order of 1 eV, between valence band and the conduction band are known as the semiconductors. In this unit, we will study the physical features and different properties of semiconductors.

All significance electronic devices like diode, transistors, switches, photovoltaic devices, LED, detectors, sensors, IC, memory devices are based on semiconductor material. Thus the properties of semiconductors are significant for design such devices. Semiconductor compounds are also used for different required purpose.

9.2 OBJECTIVES

After studying this unit, we will able to understand-

- ✓ semiconductor
- ✓ Band gap
- ✓ intrinsic and extrinsic semiconductors
- ✓ Equation of motion of electron in a semiconductor
- ✓ electron and hole mobility and conductivity
- ✓ drift current
- ✓ effective mass

- ✓ carrier concentration in semiconductors
- ✓ Thermo-physical effect

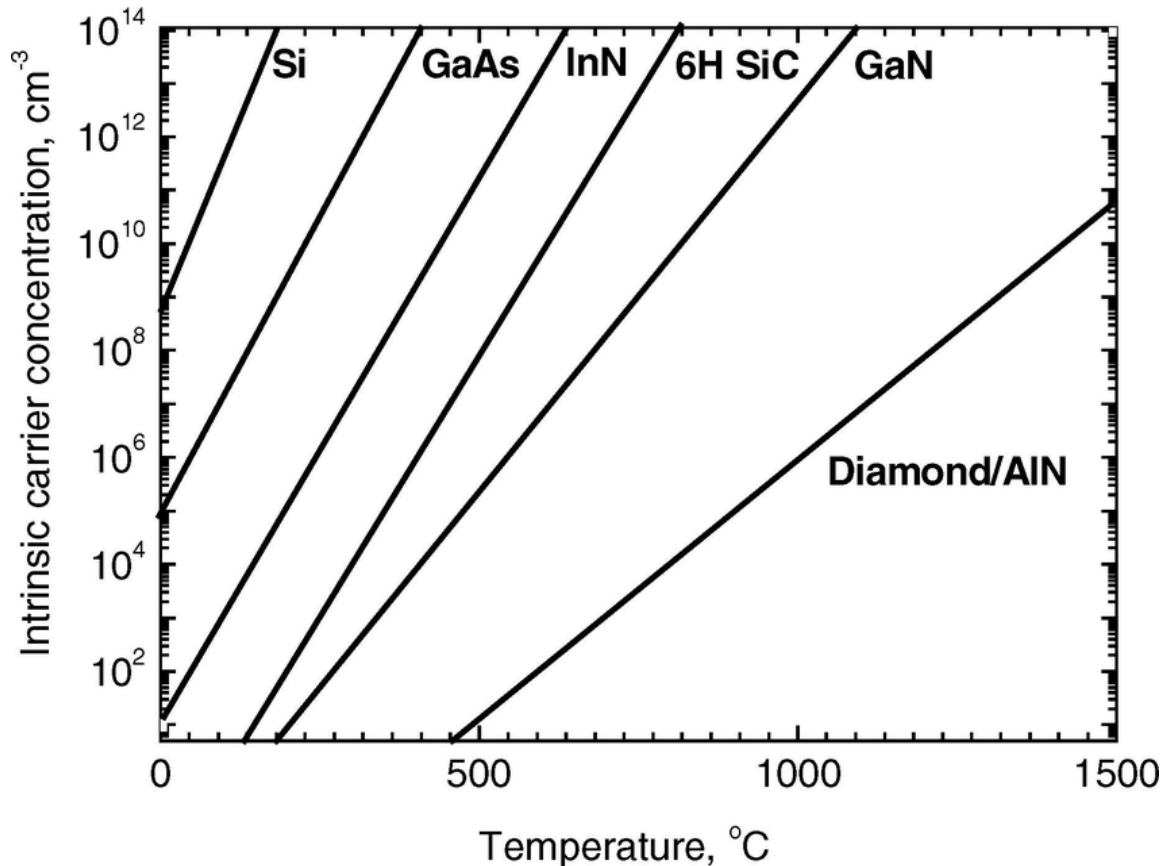

Figure 9.1: The variation of carrier concentration with temperature is shown in

9.3 SEMICONDUCTORS

The semiconductors are the solids whose conductivity lies between the very high conductivity of conductors and very low conductivity of insulators. The energy band gap between the conduction band and the valence band is narrow, which is of the order of 1 eV. At absolute zero the semiconductor behaves as insulator as there is no thermally generated charge carrier and has forbidden band gap. But at room temperature a semiconductor shows properties and may have partially filled conduction band or partially unoccupied valence band and a small energy gap of the order of 1eV. Some properties of semiconductors are:

1. The resistance of semiconductors decreases with the increase of temperature that is semiconductor have negative temperature coefficient.
2. Electrical properties of semiconductors changes on adding some impurities.

- The bonding in semiconductors is covalent which are formed by sharing of valence electrons.

9.4 TYPES OF SEMICONDUCTORS

The semiconductors are the solids whose electrical conductivity lies between the very high conductivity of metals and the very low conductivity of insulators. They are characterized by the narrow gap of the order of 1 eV between the valence band and the conduction band. Germanium and silicon have the energy gaps of around 0.7 eV and 1.1 eV respectively. Pure semiconductors are insulators at low temperatures. At room temperature, although, some of the valence electrons acquire thermal energy greater than forbidden band gap and cross over to the conduction band. A vacancy is created in the valence band at each place where an electron was present before moving to the conduction band as shown in figure 9.2. This vacancy is called the hole. The free electrons in the conduction band and the holes in the valence band can move about even under a small field. Therefore, semiconductors are slightly conducting. As the

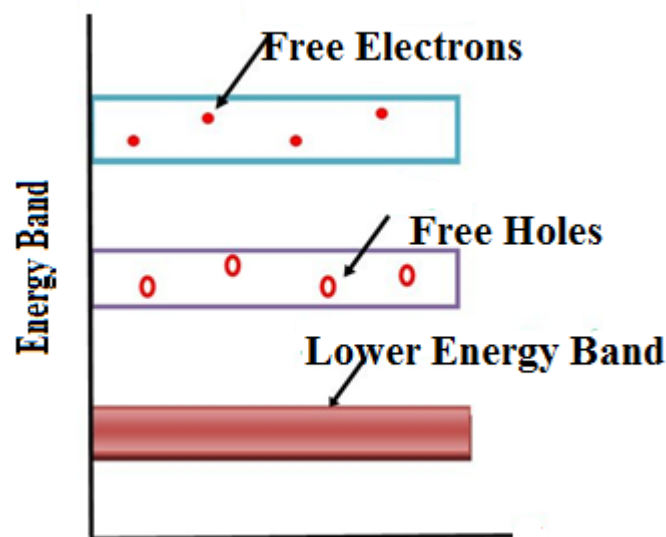

Figure 9.2: Energy Band gap

temperature increases, more and more electrons are reaching to the conduction band, leaving behind equal number of holes in the valence band. Consequently, the conductivity of semiconductors increases with the increase in temperature. Depending upon the conductivity, there are two types of semiconductors as pure semiconductors (intrinsic semiconductors) and impure semiconductors (extrinsic semiconductors).

9.4.1 Intrinsic Semiconductor

A pure semiconductor is called an intrinsic semiconductor. The electrical conductivity of these semiconductors arises by the thermal excitation of electrons from the valence band to the

conduction band. Pure Si and pure Ge are notable examples of intrinsic semiconductors. The electronic configurations of these semiconductors are as follows:

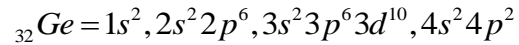
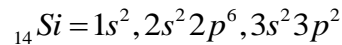

Since, atoms of Si and Ge both have four valence electrons, because of that, these are tetravalent.

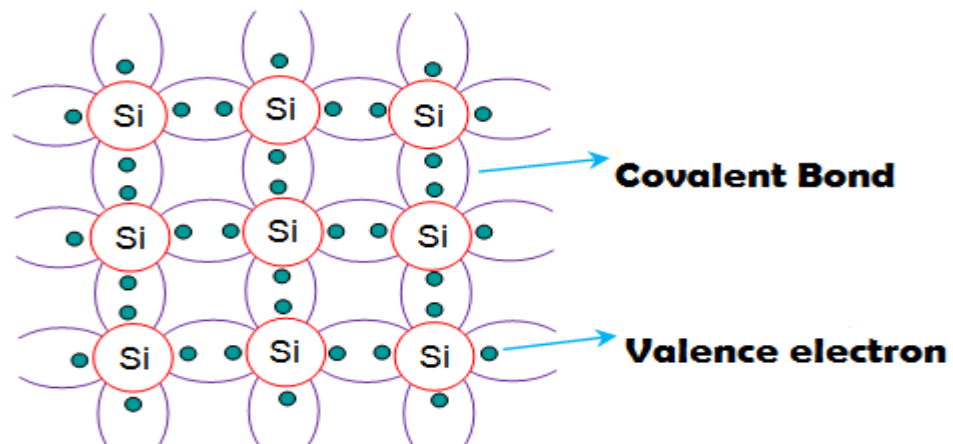

Figure 9.3: Intrinsic semiconductor

The atoms of Si and Ge have four valence electrons surrounding an inner core as shown in figure 9.3. Each of the four valence electrons of an atom is shared by an electron of its four nearest neighbours atoms and formed the covalent bonds. At temperature near to zero, all valence electrons are tightly bound to the inner core and there are no free electrons available to conduct electricity through the specimen. At room temperature, although, some of the valence electrons are thermally excited into the conduction band and become free to move about. These excited electrons leave holes in the valence band as shown in figure 9.4. Greater the temperature more is the number of electron-hole pairs created. On applying the electric field, the free electrons in the conduction band move in a direction opposite to the field and holes in the valence band move in the direction of the field also both give growth to the electric current. Therefore, in a semiconductor electrons and holes both establish current. Thus, in an intrinsic semiconductor the conduction is due to electrons and holes both and the total current is the sum of currents due to free electrons and holes. The conductivity of an intrinsic semiconductor is very poor. At normal temperature, only one covalent bond breaks in 10^9 atoms of Ge. Meaning that, only one atom in 10^9 atoms is available for conduction. So, practically there is no use of intrinsic semiconductor.

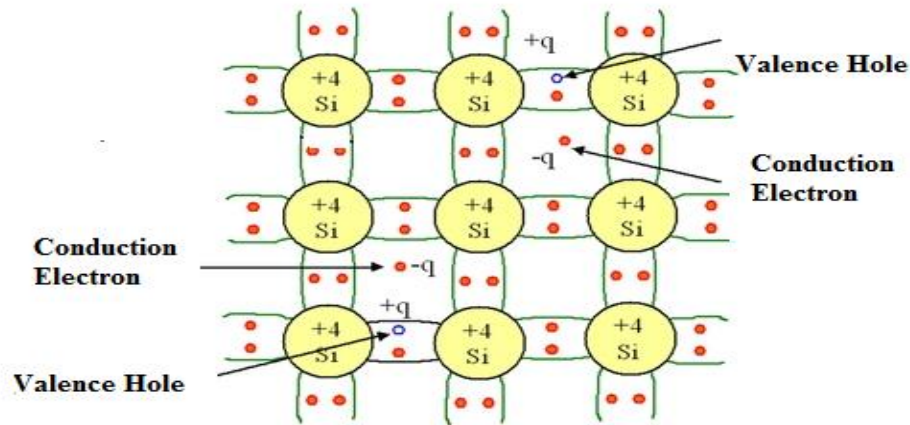

Figure 9.4: Bond formation in intrinsic semiconductor

9.4.2 Extrinsic Semiconductors

Extrinsic semiconductor is an impure semiconductor formed from a pure semiconductor by adding a small quantity of impurity atoms called dopants. The process of adding impurities to the semiconductor solid is known as doping. This added impurity is very small of the order of one atom per million atoms of pure semiconductor. Depending upon the type of impurity added to the extrinsic semiconductors are categorized as

1. n type semiconductor.
2. p type semiconductor.

9.4.2.1 n-type Semiconductor

To describe the formation of n-type semiconductor, consider that a pentavalent impurity (As), is added to a pure Ge semiconductor. As shown in figure 9.5, four of the five valence electrons of the impurity atom form covalent bond with one each valence electron of four Ge atoms nearby it. The fifth valence electron of the impurity atom requires little energy to leaves its atom. Therefore, it becomes free to move about in the crystal and acts as a free charge carrier. Therefore, on adding the pentavalent impurity to the intrinsic semiconductor, the number of free charge carriers increases, henceforth, the conductivity of semiconductors increases. The impure Si or Ge semiconductor is called the n-type semiconductor since it has an excess of negative charge carriers. The impurity atoms are called the donor atoms because they donate the electrons to the crystal.

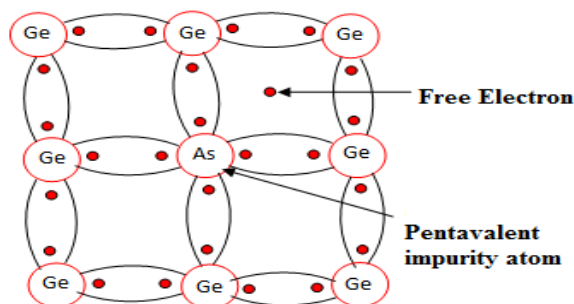

Figure 9.5: n type semiconductor

n-type semiconductor energy band diagram is shown above. The valence electron of the impurity atoms occupies the energy level just below the conduction band. This is called the donor level. This level is around 0.01 eV below the conduction band. At normal temperature, nearly all the electrons in the conduction band come from the donor levels, only a few come from the valence band. Therefore, in n type semiconductor, majority charge carriers are the electrons donated by donors. Because of the thermal excitation, there are few holes in the valence band, hence small current contributed due to holes also. Therefore, in an n type semiconductor the electrons are the majority charge carriers and holes are the minority charge carriers.

9.4.2.2 p-Type Semiconductor

In a pure (intrinsic) Si or Ge semiconductor, each nucleus uses its four valence electrons to form four covalent bonds with its neighbors as shown in figure. Each ionic core, consisting of the nucleus and non-valent electrons, has a net charge of +4, and is surrounded by 4 valence electrons. Since there are no excess electrons or holes in this case, the number of electrons and holes present at any given time will always be equal.

Now, if one of the atoms in the semiconductor lattice is replaced by an element with three valence electrons, as shown in figure 9.6, such as a Group 3 element like Boron B or Gallium Ga, the electron-hole balance will be changed. This impurity will only be able to contribute three valence electrons to the lattice, therefore leaving one excess hole as shown in figure. Since holes will accept free electrons, a Group 3 impurity of periodic table, is also called an acceptor. Since an acceptor donates excess holes, which are considered to be positively charged, a semiconductor that has been doped with an acceptor is called a p-type semiconductor, *p* stands for positive. It is observed that the material as a whole remains electrically neutral. In p-type semiconductor, the population of holes in valence band is more, whereas the population of free electrons in conduction band is less. So, current conduction is mainly because of holes in valence band. Free electrons in conduction band constitute little current. Hence in p-type semiconductor, holes are called majority carriers and free electrons are called minority carriers.

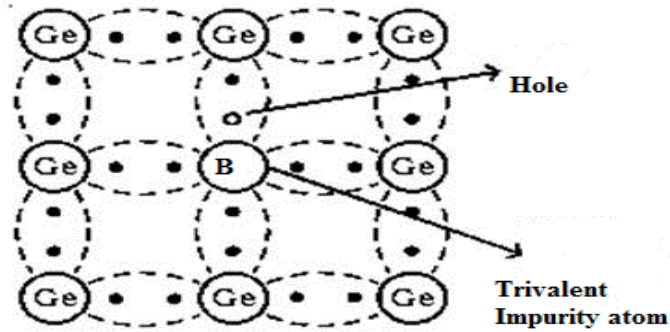

Figure 9.6: p type semiconductor

At room temperature, the number of holes in the valence band is greater than the number of electrons in the conduction band. Hence, the probability of occupation of energy levels by the holes in the valence band is greater than the probability of occupation of energy levels by the electrons in the conduction band. This probability of occupation of energy levels is represented in terms of Fermi level.

9.5 BAND GAP

The band gap is the difference in the energy between the lowest point of conduction band and highest point of valance band. The lowest point of conduction band is called conduction band edge and highest point of valance band is called valance bans edge. The carrier concentration of semiconductors largely depends on E_g/k_bT ratio of band gap and temperature. If the ratio is high the carrier concentration and conductivity will be high. The value of band gap can be determined by optical absorption. In optical absorption, the [photon energy](#) matches the energy gap between the ground excited states. The threshold of continuous optical absorption at the frequency ω_g determines the band gap. Thus the relation is given as

$$E_g = \hbar\omega_g \quad (9.1)$$

In direct absorption process a photon is absorbed by crystal with the energy exactly equal to the energy required to create an electron and hole pair. The band gap is called "direct" and the crystal momentum of electrons and holes is the same in both the conduction band and the valence band; an electron can directly emit a photon.

In the indirect absorption process, the minimum energy gap of band structure is not exactly same as the energy of photon but it involves a substantial wave vector k_c . Thus if the k-vectors are different, the material has an "indirect gap". In an "indirect" gap, a photon cannot be emitted because the electron must pass through an intermediate state and transfer momentum to the crystal lattice. In this case

$$E_g + \hbar\Omega = \hbar\omega \quad (9.2)$$

Where Ω is phonon frequency corresponding to energy transfer to of lattice and ω optical absorption at the frequency of photon. In terms of wave vector

$$K \text{ (corresponding to band gap)} + k_c(\text{phonon}) = k(\text{photon})$$

The phonon energy is very less than the photon energy. Figure 9.7 show the direct and indirect gap.

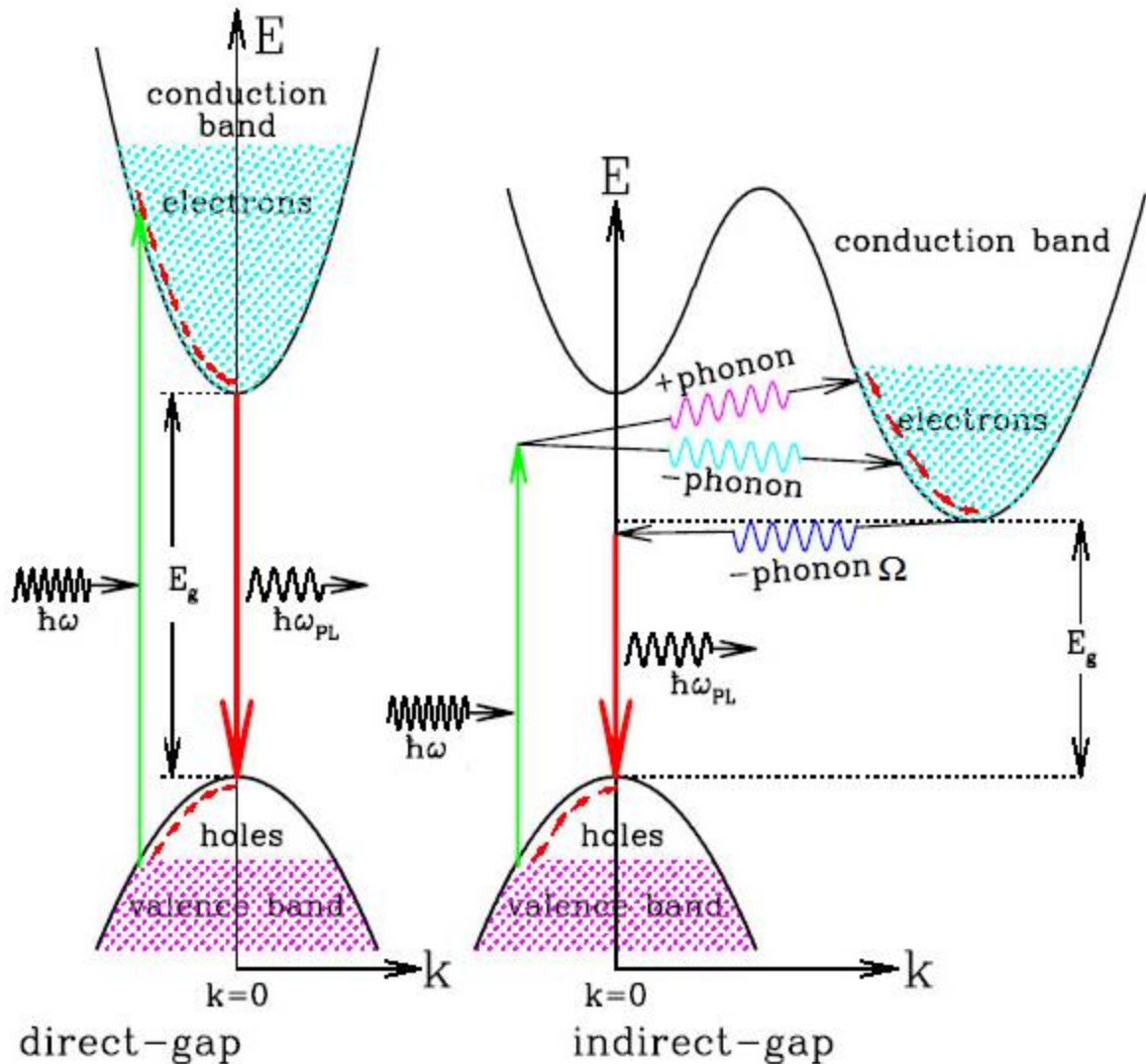

Figure 9.7: direct and indirect gap gap in semiconductors.

One important process is called radiative recombination, where an electron in the conduction band annihilates a hole in the valence band, releasing the excess energy as a photon. This is possible in a direct band gap semiconductor if the electron has a k -vector near the

conduction band minimum (the hole will share the same k-vector), but not possible in an indirect band gap semiconductor, as photons cannot carry crystal momentum, and thus conservation of crystal momentum would be violated. For radiative recombination to occur in an indirect band gap material, the process must also involve the absorption or emission of a phonon, where the phonon momentum equals the difference between the electron and hole momentum. It can also, instead, involve a crystallographic defect, which performs essentially the same role. The involvement of the phonon makes this process much less likely to occur in a given span of time, which is why radiative recombination is far slower in indirect band gap materials than direct band gap ones. This is why light-emitting and laser diodes are almost always made of direct band gap materials, and not indirect band gap ones like silicon.

The exact reverse of radiative recombination is light absorption. For the same reason as above, light with a photon energy close to the band gap can penetrate much farther before being absorbed in an indirect band gap material than a direct band gap one. This fact is very important for photo voltaic (solar cells). Crystalline silicon is the most common solar-cell substrate material, despite the fact that it is indirect-gap and therefore does not absorb light very well. As such, they are typically hundreds of microns thick; thinner wafers would allow much of the light (particularly in longer wavelengths) to simply pass through. By comparison, thin-film solar cells are made of direct band gap materials (such as amorphous silicon, Cd Te, CIGS or CZTS), which absorb the light in a much thinner region, and consequently can be made with a very thin active layer (often less than 1 micron thick).

9.6 EQUATION OF MOTION OF ELECTRON IN SEMICONDUCTORS

The equation of motion for an electron in energy band gap can be derived with the help of motion of wave packet in applied electric field. Suppose the wave packet is formed near the particular wave vector k .

The group velocity of wave packet is given as

$$v_g = d\omega/dk \quad (9.3)$$

If the energy associated with wave function is ϵ then $\epsilon = \hbar\omega$ or $d\epsilon = \hbar d\omega$

Thus

$$v_g = \hbar^{-1} d\epsilon/dk \quad (9.4)$$

The work done in an electric field in a small time interval δt can be given as

$$\delta\epsilon = eEv_g\delta t \quad (9.5)$$

Energy can also be written as $\delta\epsilon = \left(\frac{d\epsilon}{dk}\right)\delta k$ and with the help of eq. 9.4 we have

$$\delta\epsilon = \hbar v_g \delta k \quad (9.6)$$

Compare eq. 9.5 and 9.6 we have

$$eE v_g \delta t = \hbar v_g \delta k \quad \text{or} \quad eE = \hbar \delta k / \delta t$$

Since eE is force thus in term of external force the equation can be written as

$$F = \hbar \frac{dk}{dt} = \hbar \dot{k} \quad (9.7)$$

This is equation of motion in term of external force. If external force is Lorentz force than equation can be written as

$$F = \hbar \frac{dk}{dt} = eE - eV \times B$$

9.6.1 Electron and Holes

We know about electron but in semiconductor physics, hole is also significant. The deficiency of electron is simply defined as hole. Vacant orbital in a band is called hole. A hole is act in electric and magnetic field as it has chare +e. Some properties of hole are:

1. Wave vector $k_h = -k_e$ (9.8)

2. Energy: $\epsilon_h(k_h) = -\epsilon_e(k_e)$ (9.9)

3. Velocity: $v_h = v_e$ (9.10)

4. Mass: $m_h = m_e$ (9.11)

5. Lorentz force: $\hbar \frac{dk_h}{dt} = eE + eV \times B$ (9.12)

9.7 EFFECTIVE MASS OF AN ELECTRON

The electrons in a crystal are not free, but instead interact with the periodic potential of the crystal lattice. The behavior of interacting electron with crystal concerning the external forces is different from that of free electron. In the crystal lattice, the variation of the electron behavior can be grasped into account simply by seeing the electron to have an effective mass m^* rather than its free space mass m . It differs with the direction of the motion of the electron in the lattice. The energy wave

vector relation for free electron in a solid is $\epsilon = \hbar^2 k^2 / 2m$. It can be seen that shape is parabolic with the curvature is determined by k^2 . The variation of mass in bands is shown in figure 9.8. We can see the curvature is also determined by $1/m$. As curvature is high, near the band gap at zone boundary thus the reciprocal mass enhanced by same factor.

From previous unit we know that the energy of free electron conduction band is given by

$$\epsilon = \epsilon_c + \hbar^2 k^2 / 2m_e \quad (9.13)$$

Similarly, energy of hole near the edge of valance band is given as

$$\epsilon = \epsilon_v - \hbar^2 k^2 / 2m_h \quad (9.14)$$

If the curvature is negative near the valance band the effective mass of carrier is less than the mass of electron and hence negative. Thus according to band theory, the effective mass may be negative inside a crystal.

Differentiate eq. 9.4

$$\frac{v_g}{dt} = \hbar^{-1} \frac{d^2 \epsilon}{dt dk} = \hbar^{-1} \left(\frac{d^2 \epsilon}{dk^2} \frac{dk}{dt} \right)$$

From eq. 9.7 we know that $F = \hbar \frac{dk}{dt} = \hbar k$ thus above eq. becomes

$$\frac{v_g}{dt} = \hbar^{-1} \left(\frac{d^2 \epsilon}{dk^2} \frac{F}{\hbar} \right)$$

Or

$$F = \frac{\hbar^2}{d^2 \epsilon / dk^2} \frac{v_g}{dt}$$

If we compare the eq. with Newton 2nd law of motion ($F = ma$) we can observe that the quantity $\frac{\hbar^2}{d^2 \epsilon / dk^2}$ is identical to mass and define as effective mass (m^*)

$$\frac{1}{m^*} = \frac{1}{\hbar^2} \frac{d^2 \epsilon}{dk^2} \quad (9.15)$$

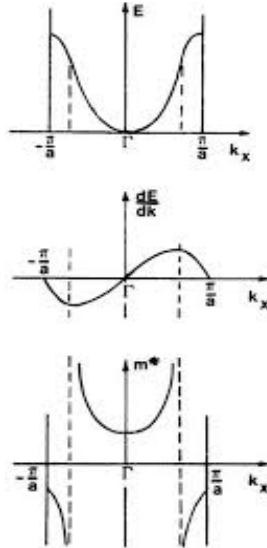

Figure 9.8: Variation of mass (effective mass) in bands.

The effective mass is a new concept and causes because of the interaction of the electron wave packet with the periodic lattice as shown in figure 9.8. The effective mass of an electron may be positive or negative as shown in figure. It is evident that the effective mass is positive in the lower part of the band and negative close to the zone boundary. The effective mass may be equal to m , only when the energy is not close the edge of the band and E versus k curve is parabolic. In case of semiconductor, where full or almost full valence bands are concerned, effective mass varies with the mass m .

9.8 INTRINSIC CARRIER CONCENTRATION IN SEMICONDUCTOR

According to Quantum Mechanics, the density of energy states per unit volume in the conduction band is given by

$$D(E) = (1/2\pi^2) \left[\frac{2m_e^*}{\hbar^2} \right]^{3/2} (E - E_C)^{1/2}, \quad (9.16)$$

where m_e^* is the effective mass of an electron. Further for charge carrier, we know the Fermi Dirac distribution function as

$$F_e(E) = \frac{1}{e^{(E-E_F)/k_B T} + 1} \quad (9.17)$$

Where symbols have usual meaning. If we take an approximation as $E - E_F \gg k_B T$, the Fermi function becomes

$$F_e(E) = \frac{1}{e^{(E-E_F)/k_B T}}$$

or,
$$F_e(E) = e^{-(E-E_F)/k_B T} \quad (9.18)$$

This is known as the Boltzmann approximation which says that all electrons in the conduction band are in narrow region at the bottom of conduction band. Now we can calculate the number of electrons per unit volume in the energy interval E and $E + dE$ in the conduction band by this relation

$$n_e(E)dE = D(E)F_e(E)dE \quad (9.19)$$

On putting the values of Fermi function and density of states, we get

$$n_e(E)d(E) = (1/2\pi^2) \left[\frac{2m_e^*}{\hbar^2} \right]^{3/2} (E - E_C)^{1/2} e^{-(E-E_F)/k_B T} dE,$$

on integrating it between the limits E and ∞ , we obtain

$$n_e(E)d(E) = \int_{E_C}^{\infty} (1/2\pi^2) \left[\frac{2m_e^*}{\hbar^2} \right]^{3/2} (E - E_C)^{1/2} e^{-(E-E_F)/k_B T} dE$$

or,
$$n_e(E) = (1/2\pi^2) \left[\frac{2m_e^*}{\hbar^2} \right]^{3/2} e^{-(E_F-E_C)/k_B T} \int_{E_C}^{\infty} (E - E_C)^{1/2} e^{-(E-E_C)/k_B T} dE$$

On substitution, $x = \frac{E - E_C}{k_B T}$ and differentiation it, $dx = \frac{dE}{k_B T}$

On putting in the above equation we get

$$n_e(E) = (1/2\pi^2) \left[\frac{2m_e^*}{\hbar^2} \right]^{3/2} (k_B T)^{3/2} e^{-(E_F-E_C)/k_B T} \int_0^{\infty} x^{1/2} e^{-x} dx$$

Where, $\int_0^{\infty} x^{1/2} e^{-x} dx$ is the standard integral, whose integration is $\pi^{1/2} / 2$

Therefore,

$$n_e(E) = (1/2\pi^2) \left[\frac{2m_e^*}{\hbar^2} \right]^{3/2} (k_B T)^{3/2} e^{-(E_F - E_C)/k_B T} \pi^{1/2} / 2$$

$$n_e(E) = 2 \left(\frac{m_e^* k_B T}{2\pi \hbar^2} \right)^{3/2} e^{(E_F - E_C)/k_B T} \quad (9.20)$$

This is the equation of electron concentration in the conduction band. Similarly, we can calculate the concentration of holes in the valence band. Hence, the concentration on holes in the valence band is written as

$$n_h(E) = 2 \left(\frac{m_h^* k_B T}{2\pi \hbar^2} \right)^{3/2} e^{(E_V - E_F)/k_B T} \quad (9.21)$$

Multiplying these two equations, we have

$$n_e n_h = 4 \left(\frac{k_B T}{2\pi \hbar^2} \right)^3 (m_e^* m_h^*)^{3/2} e^{(E_V - E_C)/k_B T}$$

Or we can write

$$n_e n_h = 4 \left(\frac{k_B T}{2\pi \hbar^2} \right)^3 (m_e^* m_h^*)^{3/2} e^{-E_g/k_B T} \quad (9.22)$$

where, $E_g = E_C - E_V$ is the forbidden energy gap. It shows that the electron and hole densities at thermal equilibrium is independent upon the Fermi level and depends only upon the forbidden energy band gap. For intrinsic semiconductors, $n_e = n_h = n_i$, therefore the above equation becomes

$$n_i = 2 \left(\frac{k_B T}{2\pi \hbar^2} \right)^{3/2} (m_e^* m_h^*)^{3/2} e^{-E_g/2k_B T} \quad (9.23)$$

This is the carrier concentration of intrinsic semiconductor and it depends exponentially on $E_g/2k_B T$.

9.8.1 Fermi Energy

It is the energy of latest occupied level below which all the states are completely occupied and above it is completely unoccupied. In intrinsic semiconductor, the electron and hole concentrations are given in equations 9.20 and 9.21 and equate these equations as

In intrinsic case $n_e = n_h = n_i$

$$2 \left(\frac{m_e^* k_B T}{2\pi \hbar^2} \right)^{3/2} e^{(E_F - E_C)/k_B T} = 2 \left(\frac{m_h^* k_B T}{2\pi \hbar^2} \right)^{3/2} e^{(E_V - E_F)/k_B T}$$

or
$$e^{\frac{2E_F - E_C - E_V}{k_B T}} = (m_h^* / m_e^*)^{3/2}$$

taking log on both sides, we have

$$\frac{2E_F - E_C - E_V}{k_B T} = (3/2) \log(m_h^* / m_e^*)$$

which gives,
$$2E_F = E_C + E_V + (3/2)k_B T \log(m_h^* / m_e^*)$$

or,
$$E_F = (E_C + E_V) / 2 + (3/4)k_B T \log(m_h^* / m_e^*) \quad (9.24)$$

If effective mass of an electron is equal to the effective mass of holes ($m_h^* = m_e^*$), putting these values in above equation, we get

$$E_F = (E_C + E_V) / 2 \quad (9.25)$$

It shows that in case of intrinsic semiconductor, Fermi level lies in middle of valence band and the conduction band as shown in figure 9.9.

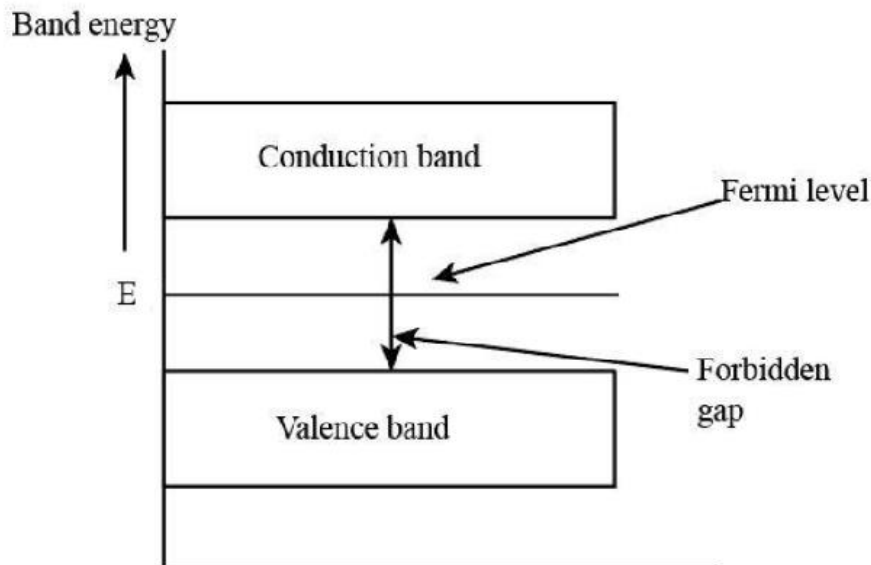

Figure 9.9: Fermi level in intrinsic semiconductor

9.9 CARRIER CONCENTRATION OF INTRINSIC SEMICONDUCTORS

In intrinsic semiconductors if we added impurity atom the electrical properties of semiconductor drastically affected. There are two cases.

9.9.1 Carrier Concentration of n Type Crystal

Impurity atom that can give the electron is called donor. The crystal remains neutral overall because the electrons remain in crystal. In case of donor type or n type semiconductors, the Fermi level, this is a measure of the top filled energy state, shifts from the middle of the energy gap towards the conduction band. Let the density of ionized donor atoms be N_d and the density of electron hole pairs in the intrinsic semiconductors be n_i at any temperature T , we have $N_d = n_i$ because of recombination of electron hole in the presence of surplus electrons. Hence, we have

$$N_d = 2 \left[\frac{2\pi m_e^* kT}{h^2} \right]^{3/2} e^{(E_F - E_C)/k_B T} \quad (9.26)$$

or,

$$N_d = N_C e^{(E_F - E_C)/k_B T} \quad (9.27)$$

Where,

$$N_C = 2 \left[\frac{2\pi m_e^* kT}{h^2} \right]^{3/2} \quad (9.28)$$

or, from above equations we get,

$$N_C / N_d = e^{-(E_F - E_C)/k_B T}$$

Taking log on both sides, we get

$$\log(N_C / N_d) = -\frac{(E_F - E_C)}{k_B T}$$

or, it becomes

$$E_F = E_C - k_B T \log(N_C / N_d) \quad (9.29)$$

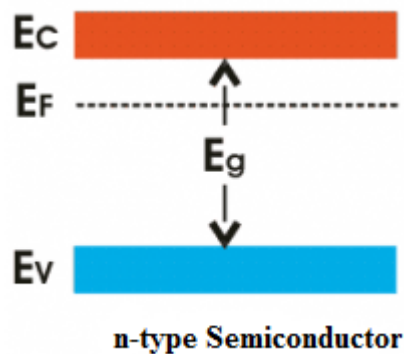

Figure 9.10: Fermi level in n type semiconductor

It shows in figure 9.10, that in n type semiconductor the Fermi level lies below the bottom of conduction band. As we increase the temperature, the Fermi level goes on falling below the conduction band (E_c). On application of potential difference across the n type semiconductor, the free electrons in the crystal are attracted towards the positive terminal and few holes towards the negative terminals. Thus, the current flow takes place. The current flow in the n type semiconductor is mainly due to the free electrons and hence in n type the majority charge carries are the electrons.

In n type semiconductor, minority charge carriers are given as

$$n_h = n_i^2 / n_e$$

or,

$$n_h = n_i^2 / N_d \quad (9.30)$$

Since, the density of free electrons is $n = n_i + N_d$, where N_d is the density of donor impurity electron and n_i is the density of intrinsic semiconductor electrons.

9.9.2 Fermi Level in the p-Type Semiconductor

Therefore, the Fermi level in the p-type semiconductor lies close to the valence band. The expression for Fermi energy in p type (acceptor type) semiconductor is given as

$$E_F = E_v + k_B T \log(N_v / N_a), \quad (9.31)$$

Where, N_a is the density of acceptor atoms and $N_v = 2 \left(\frac{2\pi m_h^* k_B T}{h^2} \right)^{3/2}$, the equation shows that the

Fermi level lies above the top of the valence band as shown in figure 9.11 and 9.12. The Fermi level depends upon the number of impurity atoms and the temperature of the specimen. On increasing the number of impurity atoms, the number of holes in the valence increases and the Fermi level shifts towards the valence band. As temperature increases, the electrons from the valence band excited to the conduction band and the crystal behaves like an intrinsic semiconductor when the number of electrons in the conduction band is equal to the number of holes in the valence band. At very high temperature, Fermi level shift towards the middle of the forbidden energy band gap.

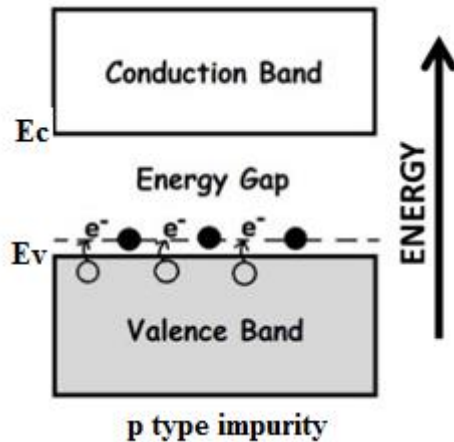

Figure 9.11: p type impurity semiconductor

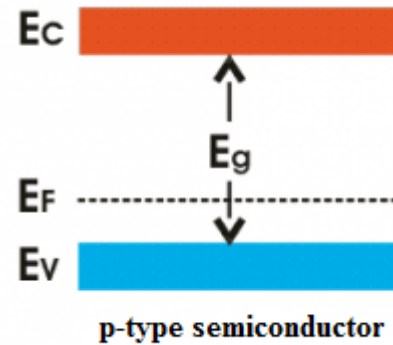

Figure 9.12: Fermi level in p type

Example 1: Pure Si at 300K has equal electron n_e and n_h concentration of $1.5 \times 10^{16} / \text{m}^3$. Doping of Boron increases hole concentrations n_h to $4.5 \times 10^{22} / \text{m}^3$. Calculate n_e in the doped Si.

Solution: We have in doped semiconductor, $n_e n_h = n_i^2$

Where, n_i is the intrinsic concentration in a pure semiconductor.

$$n_h = 4.5 \times 10^{22} / \text{m}^3$$

$$n_i = 1.5 \times 10^{16} / \text{m}^3$$

Putting these values in the above equation we get,

$$n_e = n_i^2 / n_h = \frac{(1.5 \times 10^{16})^2}{4.5 \times 10^{22}}$$

$$= 5.0 \times 10^9 / \text{m}^3$$

Example 2: The number of electron hole pair in an intrinsic semiconductor is $2 \times 10^{19} / \text{m}^3$ at 27°C . if this semiconductor is doped by a donor impurity such as the number of conduction electrons becomes $2 \times 10^{24} / \text{m}^3$, calculate the number of holes. Also calculate the dopant concentration.

Solution: for doped semiconductor, we know $n_e n_h = n_i^2$

$$n_e = 2 \times 10^{24} / \text{m}^3$$

$$n_i = 2 \times 10^{19} / \text{m}^3$$

$$n_h = n_i^2 / n_e = \frac{(2 \times 10^{19})^2}{2 \times 10^{24}}$$

$$= 2 \times 10^{14} / \text{m}^3$$

On doping it becomes an n type semiconductor.

Therefore, the number of dopant

$$N_d = n_e = 2 \times 10^{24} / \text{m}^3$$

Example 3: Show that the electron and hole concentrations in intrinsic semiconductor is constant, also called Law of Mass Action.

Solution: We have electrons and hole concentrations as

$$n_e(E) = 2 \left[\frac{2\pi m_e^* k_B T}{h^2} \right]^{3/2} e^{(E_F - E_C)/k_B T}$$

$$n_h(E) = 2 \left[\frac{2\pi m_h^* k_B T}{h^2} \right]^{3/2} e^{(E_V - E_F)/k_B T}$$

On multiplying both equations, we get

$$n_e n_h = n_i^2 = 2 \left[\frac{2\pi m_e^* k_B T}{h^2} \right]^{3/2} e^{(E_F - E_C)/k_B T} 2 \left[\frac{2\pi m_h^* k_B T}{h^2} \right]^{3/2} e^{(E_V - E_F)/k_B T}$$

or, $n_e n_h = n_i^2 \propto T^3 e^{-E_g/k_B T}$

or, $n_i \propto e^{-E_g/2k_B T}$

where, $A = 4 \left[\frac{2\pi m_e^* k_B T}{h^2} \right]^{3/2} \left[\frac{2\pi m_h^* k_B T}{h^2} \right]^{3/2}$ is a constant and k_B is the Boltzmann constant.

This equation shows that at a given temperature and certain band gap, n_i^2 is a constant. It does not depend upon the impurities introduced in it. This equation is known as law of mass action. For pure semiconductors conductivity increases with increasing temperatures, also increases on impurity doping.

9.10 Drift Current in Semiconductors

Drift current is defined as the flow of electric current due to the motion of the charge carriers under the influence of an external electric field. In a semiconductor, there are two types of charge carriers, they are electrons and holes. When the voltage is applied to a semiconductor, the free electrons move with drift velocity v_d towards the other end as indicated in figure 7.11.



Figure 9.13: Flow of charge carriers

If q is the charge carried through the section of wire in time t , then current is given as $i = q / t$

Let n be the charge density per unit volume, therefore the total number of charge carriers in passing per second through the cross-section of wire is nAv_d . So, $nAv_d t$ electrons will pass through the cross section of wire in t second. Thus, charge passing through any cross-section of wire in t second is given as

$$q = (nAv_d t)e$$

Therefore, by definition

$$i = neAv_d \quad (9.32)$$

It is well known relation between electric current and the drift velocity.

We may define current density,

$$j = i / A = nev_d \quad (9.33)$$

This is the relation of current density and drift velocity. In vector form, $\vec{j} = ne\vec{v}_d$

9.11 MOBILITY

The ability of an electron to move through a semiconductor, in the presence of applied electric field is called electron mobility. Due to the electric field, electrons and holes both drift in opposite direction with velocity \vec{v}_d and creates the current i_e and i_h respectively.

Hence,

$$i_e = n_e e A v_d$$

$$i_h = n_h e A v_d \quad (9.34)$$

Therefore, total current due to both charge carriers

$$i = i_e + i_h = n_e e A v_d + n_h e A v_d \quad (9.35)$$

or, current density $j = \frac{i}{A} = n_e e v_d + n_h e v_d \quad (9.36)$

If R is the resistance, l is length of semiconducting specimen and ρ is the resistivity, we have a relation

$$R = \rho l / A \quad (9.37)$$

If V is voltage applied and E is electric field then $E = V / l \quad (9.38)$

we get $E = \frac{V}{l} = \frac{iR}{l} = i \frac{\rho l / A}{l} = \frac{i\rho}{A}$

$$E / \rho = i / A$$

On substituting the value of i/A from eq.9.36 in above expression, we get

$$E / \rho = e(n_e v_d + n_h v_d)$$

or, $1 / \rho = e(n_e v_d + n_h v_d) / E \quad (9.39)$

Let us define a quantity, mobility due to electrons and mobility due to holes, define as

$$\mu_e = v_d / E \quad \text{and} \quad \mu_h = v_d / E \quad (9.40)$$

Hence above equation 9.39 become as

$$1 / \rho = e(n_e \mu_e + n_h \mu_h)$$

or $\sigma = e(n_e \mu_e + n_h \mu_h), \quad (9.41)$

Where σ is reciprocal of resistivity, therefore defined as conductivity of semiconductor. This is the expression of electrical conductivity of semiconductor, which depends upon the concentration and mobility of charge carriers. I would like to mention here; the mobility of electron is higher than the nobility oh holes.

Example 4: Find the conductivity of p type Ge crystal which is doped with acceptor atoms of concentration 2×10^{17} atoms/cm³ and all acceptor atoms are active. Ignore minority concentration, given $\mu_h = 1900 \text{ cm}^2 / \text{volt sec}$

Solution: In a p type semiconductor, the hole concentration is roughly equal to the acceptor concentration

That is

$$n_h = N_a = 2 \times 10^{17} / \text{cm}^3$$

We know the expression of conductivity as

$$\sigma = n_e e \mu_e + n_h e \mu_h$$

In p type semiconductor

$n_h > n_e$ and holes are the majority charge carriers, so we have $\sigma = n_h e \mu_h$

On putting the given values, we get

$$= 6100 / \text{ohm meter}$$

Example 5: The mobility of electrons and holes sample intrinsic germanium at room temperature is 0.36 and 0.17 m²/Volt/s respectively. If the electron and hole densities are each equal to $2.5 \times 10^{19} / \text{m}^3$, calculate the electrical conductivity and resistivity of germanium.

$$(a) \sigma = n_e e \mu_e + n_h e \mu_h$$

$$n_e = n_h = n_i$$

$$\sigma = 2.12 / \text{ohm} / \text{m}$$

$$\text{Resistivity } \rho = \frac{1}{\sigma} = 0.47 \Omega \text{m}$$

9.12. THERMOELECTRIC EFFECTS

When an electric current is passed through a circuit of a thermocouple, heat is evolved at one junction and absorbed at the other junction. This is known as the Peltier Effect. The **Peltier effect** is the presence of heating or cooling at an electrified junction of two different conductors and is named after French physicist Jean Charles Athanase Peltier. When a current is made to flow through a junction between two conductors, A and B, heat may be generated or removed at the junction. The Peltier heat generated at the junction per unit time is

$$\frac{dQ}{dt} = (\Pi_A - \Pi_B)I \quad (9.42)$$

where Π_A and Π_B are the Peltier coefficients of conductors A and B, and I is the electric current (from A to B). The total heat generated is not determined by the Peltier effect alone, as it may also be influenced by Joule heating and thermal-gradient effects also.

In a semiconductor the electric current density or charge flux is given as

$$j_q = nev = n \cdot (-e)(-\mu_e)E \quad (9.43)$$

Where μ_e is mobility of electron. The average energy transported by electron can be given as

$$E = (E_C - \mu) + \frac{3}{2}k_B T \quad (9.44)$$

Where $\mu = \epsilon_F$ is Fermi level and E_C is energy at the edge of conduction band.

The energy flux can be given as

$$j_U = nEv = n \cdot \left((E_C - \mu) + \frac{3}{2}k_B T \right) (-\mu_e)E \quad (9.45)$$

The Peltier coefficient is defining as the ratio of energy flux to charge flux for electron is given as

$$\Pi_e = \frac{j_U}{j_q} = \frac{\left((E_C - \mu) + \frac{3}{2}k_B T \right)}{e} \quad (9.46)$$

Similarly, for hole

$$\Pi_h = \frac{j_U}{j_q} = \frac{\left((\mu - E_V) + \frac{3}{2}k_B T \right)}{e} \quad (9.47)$$

The Peltier coefficient is related to thermoelectric power Q and T by

$$\Pi = QT \quad (9.48)$$

9.13. SUMMARY

1. The band gap is called "direct" and the crystal momentum of electrons and holes is the same in both the conduction band and the valence band; an electron can directly emit a photon.

$$E_g = \hbar\omega_g$$

2. In the indirect absorption process, the minimum energy gap of band structure is not exactly same as the energy of photon but it involves a substantial wave vector k_c .

$$E_g + \hbar\Omega = \hbar\omega$$

3. This is equation of motion in term of external force.

$$F = \hbar \frac{dk}{dt} = \hbar \dot{k}$$

4. Effective mass (m^*) is define as

$$\frac{1}{m^*} = \frac{1}{\hbar^2} \frac{d^2\epsilon}{dk^2}$$

5. Electron concentration in the conduction band

$$n_e(E) = 2 \left(\frac{m_e^* k_B T}{2\pi\hbar^2} \right)^{3/2} e^{(E_F - E_C)/k_B T}$$

Similarly, the concentration of holes in the valence band

$$n_h(E) = 2 \left(\frac{m_h^* k_B T}{2\pi\hbar^2} \right)^{3/2} e^{(E_V - E_F)/k_B T}$$

6. Fermi level can be given as

$$E_F = (E_C + E_V) / 2 + (3/4)k_B T \log(m_h^* / m_e^*)$$

If effective mass of an electron is equal to the effective mass of holes ($m_h^* = m_e^*$), then

$$E_F = (E_C + E_V) / 2$$

shows that in case of intrinsic semiconductor, Fermi level lies in middle of valence band and the conduction band.

7. Carrier concentration of donor type or n type semiconductors

$$N_d = N_C e^{(E_F - E_C)/k_B T}$$

$$N_C = 2 \left[\frac{2\pi m_e^* k_B T}{h^2} \right]^{3/2}$$

Where

$$\text{Fermi level } E_F = E_C - k_B T \log(N_C / N_d)$$

8. Fermi level of acceptor type or p type semiconductors

$$E_F = E_V + k_B T \log(N_V / N_d)$$

9. Current density $j = i / A = nev_d$

10. mobility due to electrons and mobility due to holes, define as

$$\mu_e = v_d / E \quad \text{and} \quad \mu_h = v_d / E$$

11. Conductivity is given as $\sigma = e(n_e\mu_e + n_h\mu_h)$

12. Charge flux is given as

$$j_q = nev = n \cdot (-e)(-\mu_e)E$$

13. Energy flux can be given as

$$j_U = nEv = n \cdot \left((E_C - \mu) + \frac{3}{2}k_B T \right) (-\mu_e)E$$

14. Peltier coefficient is defining as the ratio of energy flux to charge flux for electron is given as

$$\Pi_e = \frac{j_U}{j_q} = \frac{\left((E_C - \mu) + \frac{3}{2}k_B T \right)}{e}$$

15. The Peltier coefficient is related to thermoelectric power Q and T by

$$\Pi = QT$$

9.14 GLOSSARY

Intrinsic – basic (pure).

Extrinsic – impure.

Drift – flow.

Characteristic – specific.

Minority – lesser.

Majority – bulk.

Donor – contributor.

Effective – actual.

9.15 REFERENCES

1. Charles Kittel, Introduction to Solid State Physics, Wiley Eastern Limited 5th ed. 1976

2. H. C. Gupta, Solid State Physics, Vikas Publishing House Private Limited 1995
3. http://en.wikipedia.org/wiki/P-n_junction
4. <http://britneyspears.ac/physics/basics/basics.html>
5. M Singh, Elementary Solid State Physics, UOU SLM 2017
6. S L Kakani, C Hemarajani, Solid State Physics, Sultan Chand and Sons, New Delhi

9.16 SUGGESTED READINGS

1. A. J. Dekkar, Solid State Physics, The Macmillan Press Ltd. 1981
2. J. Callaway, Quantum Theory of the Solid State, Part A & B, Academic Press, New York
3. R. Kubo and T. Nagamiya, Solid State Physics, McGraw-Hill, New York (1969). 1992
4. C.M. Kachhava, Solid State Physics, Tata McGraw-Hill Publishing Company Limited 1990
5. V.K. Mehta, R. Sharma, Principal of Electronics, S.Chand Publication
6. B R Adler, A C Smith, R L Longini, Introduction to semiconductor physics, Wiley, New York
7. J D Morant, Introduction to semiconductor devices, 2nd edition, Harrap, London.
8. Millman & Halkias, Electronic Devices and Circuits, Mac. Graw Hill Book Company
9. M.A. Wahab, Solid State Physics, Alpha Science International Ltd., Harrow, U.K.

9.17 TERMINAL QUESTIONS

Short answer type questions

1. How does the energy gap in an intrinsic semiconductor vary, when doped with pentavalent impurity?
2. Why is Ge preferred over Si for making semiconductor devices?
3. What is hole? How does it behave?
4. What is the purpose of making extrinsic semiconductor by adding impurity in intrinsic semiconductor?
5. What is the effect of temperature rise on the resistivity and conductivity of a pure semiconductor?
6. Why is semiconductor damaged when a strong current is passed through it?
7. Why? Semiconductor is opaque to visible light, but transparent to infra-red radiation.
8. Calculate the intrinsic conductivity and resistivity of pure Si at room temperature, assuming intrinsic carrier (electron hole pair) density at this temperature to be $1.5 \times 10^{16}/\text{m}^3$. The electron and hole mobilities in Si are 0.135 and $0.048 \text{ m}^2/\text{V s}$ respectively.
9. The semiconductor has 6×10^{19} electrons and 7×10^{20} holes/ m^3 . If the mobilities of electrons and holes are $0.10 \text{ m}^2/\text{V s}$ and $0.06 \text{ m}^2/\text{V s}$ respectively. Calculate the conductivity of the semiconductor.
10. A Ge crystal is doped with 10^{14} donor atoms/ cm^3 . Assuming that all the donors are ionized determine the resistivity of the doped sample. ($\mu_e = 0.39 \text{ m}^2/\text{Vs}$).

Long answer type questions

1. Explain the difference between intrinsic and extrinsic semiconductor. Find out the expression for carrier concentration of intrinsic semiconductors.
2. Show that the Fermi level for extrinsic semiconductors lies exactly between the conduction and valance band.
3. Find out the expression for carrier concentration and Fermi level of donor type semiconductor.
4. Find out the expression for carrier concentration and Fermi level of acceptor type semiconductor.

Objective type questions

1. Silicon has 14 electrons. Its outermost orbit is
 - (a) Empty
 - (b) Completely filled
 - (c) Half filled
 - (d) None of the above
2. Main current in an intrinsic semiconductor is due to
 - (a) Conduction band electrons
 - (b) Valence band holes
 - (c) Valence band electrons
 - (d) Thermally generated electrons
3. When Ge is doped with indium, it becomes
 - (a) N type semiconductor
 - (b) P type semiconductor
 - (c) An insulator
 - (d) Photo transistor
4. The energy gap between the valence and conduction bands in a semiconductor is of the order of
 - (a) 0.025 eV
 - (b) 1 eV
 - (c) 6 eV
 - (d) Negligible
5. An example of p type semiconductor is
 - (a) pure Ge

- (b) germanium doped with arsenic
- (c) silicon doped with boron
- (d) germanium doped with carbon

9.18 ANSWERS

Short answer types

1. Energy gap decreases.
2. The energy gap for Ge is only about 0.7 eV while for Si it is about 1.1 eV.
3. A hole indicates a vacancy left by an electron in the p type semiconductor. It behaves like a positively charged particle.
4. Since the conductivity of intrinsic semiconductor is very small. By introducing impurity in it, the conductivity of semiconductor is increased.
5. The resistivity decreases, conductivity increases.
6. Since at room temperature, a semiconductor has a finite resistance. When a strong current is passed through it, it gets heated and the covalent bonds break up. This give rise to a very large number of free electrons. The semiconductor then behaves like a conductor that is why; it ceases to be a conductor.
7. Valence band of semiconductor is full; above it there is an empty conduction band with a very small gap of around 1 eV in between them. Photons of visible light have energies roughly between 1 and 3 eV and so they are absorbed by the valence electrons which are excited to the conduction band. Thus, the semiconductor is opaque to the visible light. The photons of infra-red radiation are of much smaller energies and fail to excite the electrons in the valence band. So, the infra-red radiation passes through the semiconductor, because of that, the semiconductor is transparent to it.
8. Conductivity = 4.4×10^{-4} / ohm meter, resistivity = 2.27×10^3 ohm meter
9. Conductivity = 7.68 / ohm meter, 10. Resistivity = 0.16 ohm meter

UNIT 10**DIELECTRICS**

Structure

- 10.1 Introduction
- 10.2 Objectives
- 10.3 Some important definitions
 - 10.3.1 Electric dipoles
 - 10.3.2 Electric field intensity or electric field strength (E)
 - 10.3.3 Electric flux density or electric displacement vector (D)
 - 10.3.4 Dielectric constant (ϵ_r)
 - 10.3.5 Capacitance
- 10.4 Polarization
 - 10.4.1 Relation between polarization and dielectric constant
- 10.5 Types of Polarizability
 - 10.5.1 Ionic polarizability
 - 10.5.2 Electronic polarizability
 - 10.5.3 Oriental polarizability
 - 10.5.4 Molecular polarizability
- 10.6 Frequency Dependence of Dielectric Properties
- 10.7 Internal field (Or Local field) in liquids and solids (one dimensional)
- 10.8 Clausius-Mossotti relation
- 10.9 Ferroelectrics
- 10.10 Antiferroelectricity
- 10.11 Piezoelectricity
- 10.12 Summary
- 10.13 Glossary
- 10.14 References
- 10.15 Suggested Readings
- 10.16 Terminal questions

10.1 INTRODUCTION

Dielectrics are insulating or non-conducting ceramic materials. They exhibit the property of electrical polarization, thus modify the dielectric function of the vacuum. A dielectric material is a material that supports charge without conducting it to a significant degree. In principle all insulators are dielectric, although the capacity to support charge varies greatly between different insulators. These materials do not conduct electrical current when an electric field is applied, they are not inert to the electric field. The field may cause a slight shift in the balance of charge within the material to form an electric dipole. They are used in many applications such as capacitors, memories, sensors, actuators etc.

The first numerical measurements on the properties of insulating materials when placed between the two parallel plates (capacitor), was carried out by Faraday and the insulating material is known as dielectrics. He establishes that the capacity of a condenser was dependent on the nature of the material separating the conducting surface. This discovery encouraged further empirical studies of insulating materials aiming at maximizing the amount of charge that can be stored by a capacitor. In search of suitable dielectric materials for specific applications, these materials have become increasingly concerned with the detailed physical mechanism governing the behaviour of these materials.

10.2 OBJECTIVES

After studying this chapter, you will be able to know

- ✓ Dielectric materials
- ✓ Polarizability
- ✓ The different ways of polarization of materials
- ✓ Clausius-Mossotti relation
- ✓ Ferroelectricity, Antiferroelectricity, Piezoelectricity

10.3 SOME IMPORTANT DEFINITIONS

10.3.1 Electric Dipoles

Upon application of a dc or static electric field in a material, there is a limited movement of charges leading to the formation of charge dipoles and the material, this state, is considered as polarized. These dipoles are aligned in the direction of the applied field. The net effect is called Polarization of the material. A dielectric supports charge by acquiring a polarization in an electric field, whereby one surface develops a net positive charge while the opposite surface develops a net negative charge. This is made possible by the presence of electric dipoles – two opposite charges separated by a certain distance – on a microscopic scale.

1. If two discrete charged particles of opposite charges are separated by a certain distance, a dipole moment μ arises (Figure 10.1).

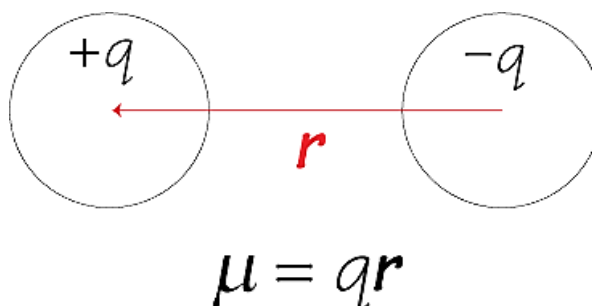

Figure: 10.1

2. If the centre of positive charge within a given region and the centre of negative charge within the same region are not in the same position, a dipole moment μ arises. For example, in the Figure 10.2 below the centre of positive charge from the 8 cations shown is at X, while the centre of negative charge is located some distance away on the anion.

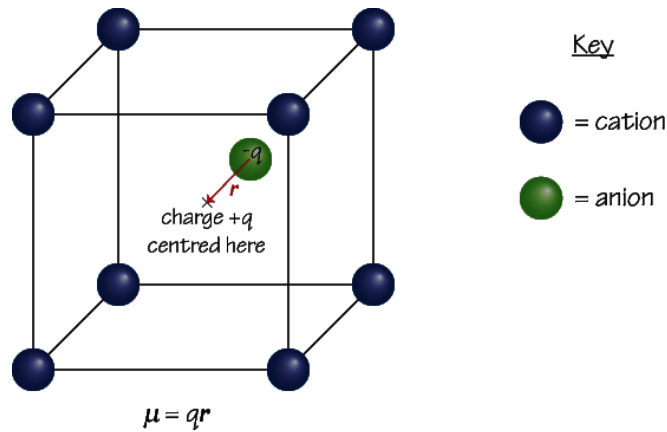

Figure: 10.2

3. The second view of dipole moment is more useful, since it can be applied over a large area containing many charges in order to find the net dipole moment of the material.

The dipoles can be aligned as well as be induced by the applied field

Note that in the equation for dipole moment, r is a vector (the sign convention is that r points from negative to positive charge) therefore the dipole moment μ is also a vector

10.3.2 Electric Field Intensity or Electric Field Strength (E)

The force experienced by a unit test charge is known as electric field strength E

$$E = \frac{Q}{4\pi\epsilon r^2} \quad (10.1)$$

where ϵ is the permittivity or dielectric constant of the medium in which electric charge is placed.
 For vacuum $\epsilon = \epsilon_0 = 8.854 \times 10^{-12} \text{ Fm}^{-1}$

10.3.3 Electric Flux Density or Electric Displacement Vector (D)

The electric flux density or electric displacement vector is the number of flux lines crossing normal to a unit surface area. The electric flux density at a distance from the point charge Q is

$$D = \frac{Q}{4\pi r^2} \quad (10.2)$$

By using equation from (10.1) and (10.2), we will get the relation between D, ϵ , and E as:

$$D = \epsilon E \quad (10.3)$$

10.3.4 Dielectric Constant (ϵ_r)

The dielectric constant of a material is defined as the ratio of the permittivity of the medium (ϵ) to the permittivity of free space (ϵ_0). It can also be defined as the ratio of the capacitance with dielectric (C_d) and with air (C_A) between the plates.

$$\epsilon_r = \frac{\epsilon}{\epsilon_0} = \frac{C_d}{C_A} \quad (10.4)$$

It gives the expression for the extent to which a material concentrates electric flux. It is electrically equivalent to relative magnetic permeability.

10.3.5 Capacitance

The property of a conductor or system of conductor that describes its ability to store electric charge.

$$C = q/V = A \epsilon/d$$

Where, the terms have their usual meaning: C is capacitance of capacitor, q is charge on the capacitor plate V is potential difference between plates, A is area of capacitor plate, ϵ is permittivity of medium and d is distance between capacitor plates. Unit of charge is Farad.

10.4 POLARIZATION

When an electric field is applied to a material with dielectrics, the positive charges are displaced opposite to the direction of the field and negative charges displaced in the direction of the field. The displacement of these two charges create a local dipole, creation of dipole by applying electric field is called as polarization. Polarization is defined as induced dipole moment per unit volume.

$$P = \frac{\mu}{Volume} \quad (10.5)$$

Polarizability:

Polarization or polarizability is the ability to form instantaneous dipoles. It is a property of matter

which determines the dynamical response of a bound system to external fields and provide insights into the molecular internal structure. Normally, in a solid polarizability is defined as the dipole moment per unit volume of crystal.

The polarization P is directly proportional to the electric field strength E

$$P \propto E \quad P = \alpha E \quad (10.6)$$

Where α proportionality is constant called as polarizability. The polarizability is defined as polarization per unit applied electric field. If the material contains N number of dipoles per unit volume, then

$$P = N \alpha E$$

10.4.1 Relation between Polarization and Dielectric Constant

Let us consider a parallel plate condenser. Applying Gauss theorem on it. We will get:

$$\int E_0 dA = \frac{q}{\epsilon_0}$$

$$E_0 dA = \frac{q}{\epsilon_0}$$

$$E_0 = \frac{q}{A\epsilon_0} = \frac{\sigma}{\epsilon_0}$$

Here σ is the charge per unit area. Let us suppose a dielectric slab is put between the capacitor. The charges appear on the two faces of the slab due to the polarization and establish another field within the dielectric media. Suppose this field is E' and its direction is opposite to the direction of E_0 . Hence the resultant field E in the material can be written as:

$$E = E_0 - E'$$

Let σ_p is the charge per unit area on the dielectric slab that is inserted in between the capacitor. Hence the equation can be changed as:

$$E = \frac{\sigma}{\epsilon_0} - \frac{\sigma_p}{\epsilon_0}$$

Or

$$\epsilon_0 E = \sigma - \sigma_p$$

The magnitude of polarization P is given as dipole moment per unit volume and dipole moment is given as multiplication of induced charge and distance

So P can be given as:

$$P = \frac{\text{induced charge}}{\text{Area}} = \sigma_p$$

We know that electric displacement field or electric flux density D is given by charge /unit area

$$D = \frac{q}{A} = \sigma$$

Hence the equation $\epsilon_0 E = \sigma - \sigma_p$ becomes

$$\epsilon_0 E = D - P$$

$$P = D - \epsilon_0 E$$

in free space where there is no dielectric $P=0$

$$D = \epsilon_0 E$$

But in dielectric media the D changes. From electrostatics

$$D = \epsilon_r \epsilon_0 E$$

On putting the value of D in the equation of P, we get

$$P = \epsilon_r \epsilon_0 E - \epsilon_0 E$$

$$P = \epsilon_0 E (\epsilon_r - 1)$$

$$\text{Or } (\epsilon_r - 1) = \frac{P}{\epsilon_0 E} = \chi \quad (10.7)$$

where χ is the electric susceptibility of the dielectric medium. It is unit less quantity.

10.5 TYPES OF POLARIZABILITY

There are four different types of polarizability, they are listed below.

1. Ionic polarizability
2. Electronic polarizability
3. Oriental polarizability
4. Molecular polarizability

10.5.1 Ionic Polarizability

Ionic polarizability is a measure of how easily an electron cloud can be distorted by an electric field. Ionic polarization occurs in ionic solids such as NaCl, KBr, and LiBr. When an electric field is applied to an ionic solid the positive and negative ions displace to their respective polarities creating an electric dipole this is called as ionic polarization.

1. Ionic polarization occurs due to the relative displacement between positive and negative ions in an ionic crystal.
2. If a crystal or molecule consists of atoms of more than one kind, the distribution of charge around an atom in the crystal or molecules leads to positive or negative. As a result, when lattice vibrations or induced vibrations induces relative displacement of atoms centres of positive and negative charges are also displaced. The location of these centres are affected by symmetry of displacement.
3. Then the centres do not correspond, polarization arises in molecules or crystals. The displacement and thus ionic polarizability is independent of temperature.

In order to derive ionic polarizability(α_i), consider the diagram showing ionic structure of NaCl. Let x_1 and x_2 be the displacement of Na^+ and Cl^- ions respectively then electric field E is applied (Figure 10.3).

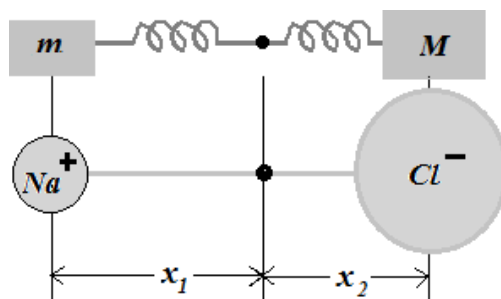

Figure: 10.3

The resultant dipole moment per unit cell is given by

$$\mu = e(x_1 + x_2) \quad (10.8)$$

Where e is the magnitude of the charge. When electric field is applied, due to the displacement of ions, a restoring force is produced which tend to bring ions back into their original position.

Let F be restoring force. For positive ions:

$$F \propto x_1$$

$$F = \beta_1 x_1$$

For negative ions:

$$F \propto x_2$$

$$F = \beta_2 x_2$$

β_1 and β_2 are the constant, which depend upon the mass of ions and the angular frequency of vibrations of molecules.

Let us suppose ω_0 be the angular frequency and m, M are the masses of cations and anions respectively. From mechanics the spring constant of mass attached to a spring given by $\beta = m\omega^2$, at equilibrium the Lorentz force and restoring force are equal.

$$eE = m\omega_0^2 x$$

Therefore;

$$x = \frac{eE}{m\omega_0^2}$$

$$x_1 = \frac{eE}{m\omega_0^2}, \quad x_2 = \frac{eE}{M\omega_0^2}$$

$$\mu = \frac{e^2}{\omega_0^2} \left[\frac{1}{m} + \frac{1}{M} \right] E = \alpha_i E \quad (10.9)$$

where,

$$\alpha_i = \frac{e^2}{\omega_0^2} \left[\frac{1}{m} + \frac{1}{M} \right] E \quad (10.10)$$

Equation 10.10 gives expression for ionic polarizability and α_i is called as ionic polarisability. Where ω_0 is the angular frequency, e is the magnitude of the charge, m, M are the masses of ions.

10.5.2 Electronic Polarizability

Electronic polarizability is the relative tendency of a charge distribution like the electron cloud of an atom or molecule and consequently of any material body to have its charges displaced by any external electric field, which in the uniform case is applied typically by a charged parallel plate capacitor. In all circumstances the application of electric field causes some distortions of electronic cloud relative to Nucleus. This is known as electronic polarizability.

On applying a field, the electron cloud around the nucleus shifts towards the positive end of the field. As the nucleus and electron cloud are separated by a distance, dipole moment is created within each atom. The extent of this shift is proportional to the field strength.

Induced dipole moment

$$\mu_e \propto E$$

$$\mu_e = \alpha_e E$$

Where α_e is called electronic polarizability. The dipole moment per unit volume is called electronic polarization.

- It increases with increase of volume of the atom.
- This kind of polarization is mostly exhibited in monoatomic gases.(e.g. He, Ne, Ar, Kr, Xe etc..)
- It is independent of temperature.
- It occurs only at optical frequencies(10^{15} Hz)
- Vast fast process: $10^{-15} \sim 10^{-16}$ s.

Calculation of electronic polarizability

Electronic polarization can be explained by classical model of an atom in gasses. An atom can be thought of having a centre positive charge $+Ze$ at nucleus and a smeared out electron cloud of charge $-Ze$. The electron cloud is assumed to be spherical region of uniform charge of radius a . When an external field is applied the centre of positive charge and the centre of negative charge shift by a distance d with respect to one another. Here the nucleus of charge Ze is surrounded by an electron cloud of charge $-Ze$ distributed in the sphere of radius R . Charge density is given as:

$$\text{Charge density, } \rho = -\frac{Ze}{(4/3)\pi r^3} \quad (10.11)$$

When an electric field E is applied, the nucleus and electrons experience Lorentz force of magnitude ZeE in opposite direction. Therefore, the nucleus and electrons are pulled apart. At equilibrium these two forces are equal and nucleus and electron cloud are separated by a small distance x (Figure 10.4).

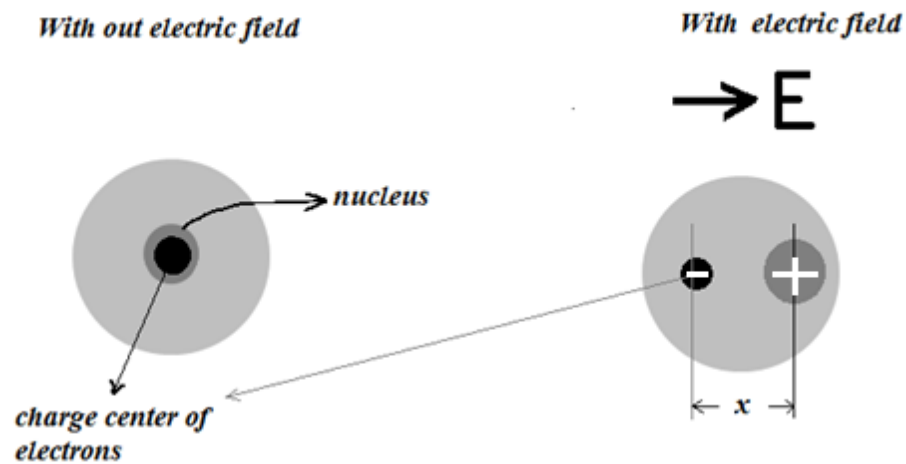

Figure: 10.4

$$\text{Lorentz force} = -ZeE \quad (10.12)$$

$$\text{Coulomb force} = Ze \times \frac{\text{Charge enclosed in the sphere of radius } x}{4\pi \epsilon_0 x^2}$$

$$\text{The charge enclosed} = \frac{4}{3}\pi x^3 \rho$$

From the equation 10.11, the value of charge enclosed can be given as:

$$\begin{aligned} &= \frac{4}{3}\pi x^3 \left[-\frac{3}{4} \left(\frac{Ze}{\pi R^3} \right) \right] \\ &= -\frac{Zex^3}{R^3} \end{aligned}$$

Hence the Coulomb force can be written as:

$$= -\frac{Ze}{4\pi\epsilon_0 x^2} X - \frac{Zex^3}{R^3} = -\frac{Z^2 e^2 x}{4\pi\epsilon_0 R^3} \quad (10.13)$$

At the position of equilibrium, the Lorentz and coulomb forces are equal. Therefore:

$$-ZeE = -\frac{Z^2 e^2 x}{4\pi\epsilon_0 R^3}$$

or

$$x = -\frac{4\pi\epsilon_0 R^3 E}{Ze} \quad (10.14)$$

The displacement of the electron cloud is proportional to applied electric field. Hence the value of the electric dipole moment can be written as

$$\begin{aligned} \mu_e &= Zex = \frac{Ze4\pi\epsilon_0 R^3 E}{Ze} \\ \mu_e &= 4\pi\epsilon_0 R^3 E \\ \mu_e &\propto E \\ \mu_e &\propto \alpha_e E \end{aligned} \quad (10.15)$$

From the equation 10.15, α_e is called electronic polarizability and its value is $\alpha_e = 4\pi\epsilon_0 R^3$. We know that;

$$P_e = N\mu_e$$

As we know that $\mu_e \propto \alpha_e E$, so the above equation may be written as:

$$P_e = N\alpha_e E_e$$

Where N is the number of atoms/m³. However, the polarization can be given as:

$$P = E\epsilon_0(\epsilon_{r-1}) = N\alpha_e E$$

$$(\epsilon_{r-1}) = \frac{N\alpha_e}{\epsilon_0}$$

$$\text{Or } \alpha_e = \frac{(\epsilon_{r-1})}{N} \epsilon_0$$

10.5.3 Orientation Polarizability

Orientation polarizability is a kind of polarizability which occurs in liquids and solids which have symmetric molecules whose permanent dipole moment can be aligned by electric field. So we can

say that, orientation polarization occurs only in polar molecules (the molecules which have permanent dipole moment eg H₂O, Phenol, etc.). In order to find orientation polarizability, let us consider a system of a permanent dipole with dipole moment P is subjected to an external field be parallel to x axis. When an electric field is applied to a polar molecule, the dipoles experience a torque and try to align parallel to the applied field.

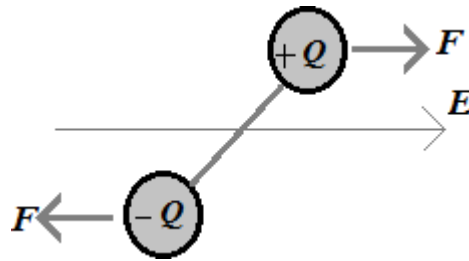

Figure: 10.5

Consider a polar molecule subjected to an electric field E . The alignment of electric dipole with the electric field is similar to the alignment of magnetic dipole with the applied magnetic field in paramagnetic material (Figure 10.5).

The expression for polarization can be obtained from the theory of paramagnetism. The orientation polarization is given as;

$$P_0 = \frac{N\mu_0^2 E}{3KT} = \alpha_0 E \quad (10.16)$$

$$\alpha_0 = \frac{\mu_0^2}{3KT} \quad (10.17)$$

Where $\alpha_0 = \frac{\mu_0^2}{3KT}$ is known as orientation polarisability.

Space charge polarization:

Space charge polarization occurs due to the accumulation of charges at the electrodes or at interfaces in a multiphase material.

In the presence of an applied field, the mobile positive ions and negative ions migrate toward the negative electrode and positive electrode respectively to an appreciable distance giving rise to redistribution of charges, but they remain remains in the dielectric material (electrode is blocking).

The space charge polarization can be defined as the redistribution of charges due to the applied

electric field and the charges accumulate on the surface of the electrodes (Figure 10.6). It occurs when the rate of charge accumulation is different from rate of charge removal. Space charge polarization is not significant in most of the dielectric materials.

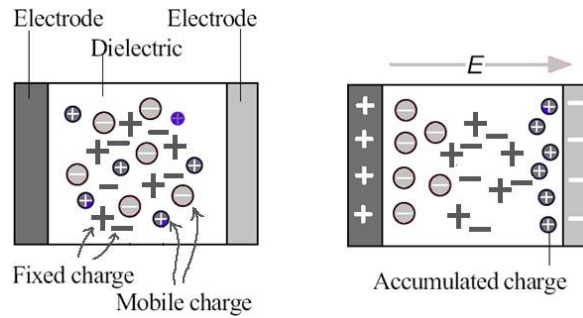

Figure: 10.6

10.5.4 Molecular Polarizability

When a beam of light is incident on a transparent material medium of refractive index different from that of the surroundings, the medium gets polarized. If a light wave of electric intensity E goes past a molecule in a medium it induces an optic moment in the molecule. The molecule is said to be polarized. In the absence of an electric field the electron of mass “ m ” would oscillate with frequency ν_0 , which is given by:

$$\nu_0 = \frac{1}{2\pi} \sqrt{\frac{k}{m}}$$

$$k = 4\pi m\nu_0^2$$

By neglecting damping, molecular polarizability (α_m) can be given as:

$$\alpha_m = \frac{e^2}{k}$$

On putting the value of k in the above equation, we can get value of α_m .

$$\alpha_m = \frac{e^2}{4\pi m\nu_0^2} \quad (10.18)$$

10.6 FREQUENCY DEPENDENCE OF DIELECTRIC PROPERTIES

Different dielectric properties depend upon the frequency of applied field and temperature. In this section we will discuss the frequency dependence of polarisation and dielectric constant:

Dielectric constant is very much affected by the frequency of applied voltage. The frequency dependence of dielectric constant on the frequency is shown in the figure.

Atomic polarization is present in all materials by definition and hence any other mechanism would be an addition.

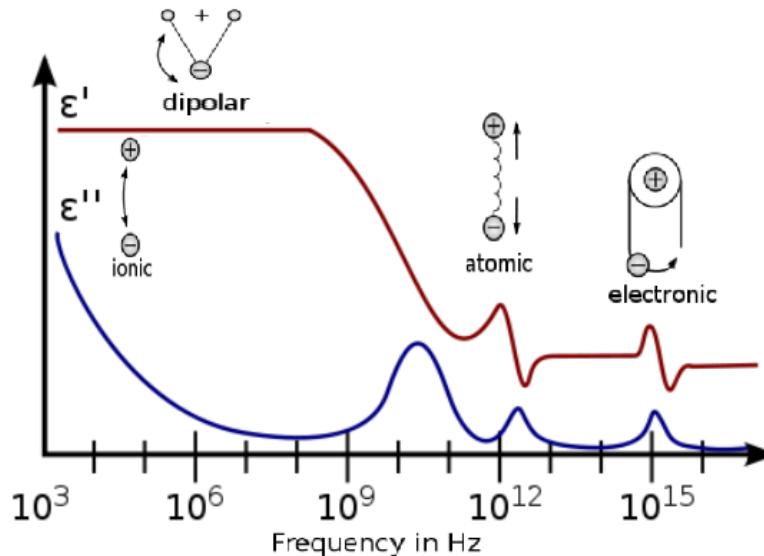

Figure 10.7: Schematic diagram between dielectric constant vs frequency showing various mechanism.

Qualitatively, we can see that in the above four mechanisms, the masses of the entities to be displaced are different, with mass getting larger from electronic to ionic to dipolar polarization. This has a direct relation with the frequency of the applied field (Figure 10.7). Intuitively, we can mention that heavier the particular entity, more is the time spent in displacing it. As a result, atomic polarization is the fastest and typically persists at frequencies between $\sim 10^{13}$ - 10^{15} Hz. In contrast, ionic polarization is sluggish and typically occurs at frequencies between $\sim 10^9$ - 10^{13} Hz while

dipolar polarization involving movement of molecules happens below 10⁹ Hz. Interface or space charge polarization occurs at frequencies below 10 Hz.

For non-magnetic dielectrics, Maxwell's electromagnetic theory predicts that the dielectric constant obtained from the electronic contribution is also related to the index of refraction as $\epsilon_r = n^2$ which is true at very high frequencies, above 10¹²-10¹³ Hz. Contribution from another mechanism will be on top of it. Carbon and germanium being single elemental materials show electronic polarization only and as a result their dielectric constants match well with the values of n^2 . However, the same is not the case with NaCl or water which have strong contributions of ionic and dipolar polarization respectively

10.7 INTERNAL FIELD (OR LOCAL FIELD) IN LIQUIDS AND SOLIDS (ONE DIMENSIONAL)

In gases state the atoms are separated by large distances and the interaction between the atoms can be neglected. When an external electric field E is applied, the intensity of the electric field experienced by an atom in gases state will be equal to the applied electric field E .

In solids and liquids, the atoms are close to each other leading to strong interaction between them. In solids and liquids, the intensity of the electric field at a given point of the material is not equal to the applied electric field but equal to internal field which is the sum of applied electric field and field due to other dipoles present in the material.

Internal field $E_i = E + E'$

The internal field can be calculated by Epstein model in the case of one dimensional atomic array.

Electric field along the axis of an electric dipole

Consider an electric dipole of length $2d$ and charge Q , the field along the axis of the dipole at point A is the sum of the electric field due to $+Q$ and $-Q$ (Figure 10.8).

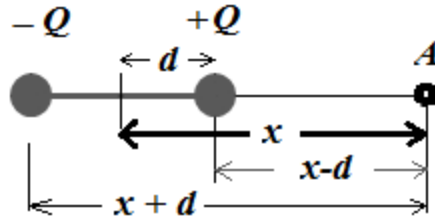

Figure 10.8

The electric field due to +Q at point A is $E^+ = \frac{Q}{4\pi\epsilon_0(x-d)^2}$

The electric field due to -Q at point A is $E^- = \frac{Q}{4\pi\epsilon_0(x+d)^2}$

$$\begin{aligned} \text{Electric field of dipole at A is } E_A &= E^+ - E^- = \frac{Q}{4\pi\epsilon_0} \left[\frac{1}{(x-d)^2} - \frac{1}{(x+d)^2} \right] \\ &= \frac{2Q}{4\pi\epsilon_0} \left[\frac{2dx}{(x-d)^2(x+d)^2} \right] \end{aligned}$$

Since $x \gg d$, $(x-d)^2 \approx (x+d)^2 \approx x^2$ then

$$= \frac{2Q}{4\pi\epsilon_0} \left[\frac{2dx}{x^4} \right] = \frac{4dQ}{4\pi\epsilon_0 x^3}$$

$$\text{Since } 2dQ = \mu_i E_A = \frac{2\mu_i}{4\pi\epsilon_0 x^3}$$

Consider an array of one dimensional atoms along x- axis. The all the atoms are similar, equally spaced and have induced electric dipole moment μ_i in an applied electric field E (Figure 10.9).

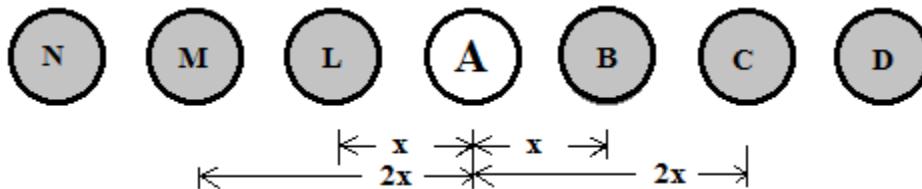

Figure 10.9

The electric field experienced at the A is the sum of electric fields of other dipoles and applied electric field E . The electric field at A due to the induced dipole B and L at a distance x is

$$E_B = E_L = \frac{2\mu_i}{4\pi\epsilon_0 x^3}$$

The electric field at A due to the induced dipole C and M which are at a distance $2x$ is

$$E_C = E_M = \frac{2\mu_i}{4\pi\epsilon_0(2x)^3}$$

Consequently, the field due to other dipoles is given as:

$$E' = E_B + E_L + E_C + E_M + E_D + \dots$$

On putting the values of $E_B, E_L, E_C, E_M \dots$ The above equation becomes:

$$E' = \frac{2\mu_i}{4\pi\epsilon_0x^3} + \frac{2\mu_i}{4\pi\epsilon_0x^3} + \frac{2\mu_i}{4\pi\epsilon_0(2x)^3} + \frac{2\mu_i}{4\pi\epsilon_0(2x)^3} + \frac{2\mu_i}{4\pi\epsilon_0(3x)^3} + \frac{2\mu_i}{4\pi\epsilon_0(3x)^3} + \dots$$

$$E' = \frac{4\mu_i}{4\pi\epsilon_0x^3} + \frac{4\mu_i}{4\pi\epsilon_0(2x)^3} + \frac{4\mu_i}{4\pi\epsilon_0(3x)^3} \dots$$

$$E' = \frac{\mu_i}{\pi\epsilon_0x^3} \left[1 + \frac{1}{2^3} + \frac{1}{3^3} + \frac{1}{4^3} + \frac{1}{5^3} + \frac{1}{6^3} + \dots \right]$$

$$1 + \frac{1}{2^3} + \frac{1}{3^3} + \frac{1}{4^3} + \frac{1}{5^3} + \frac{1}{6^3} + \dots = 1.2$$

$$E' = \frac{1.2\mu_i}{\pi\epsilon_0x^3}$$

Therefore, the internal field can be given as;

$$E_i = E + \frac{1.2\mu_i}{\pi\epsilon_0x^3}$$

The local field in a three dimensional solid is similar the above equation the number density N of atoms replaces $1/a^3$. Since $N\mu_i = P$ and $1.2/\pi$ is replaced by γ . Then the internal field is given as

$$E_i = E + \frac{1.2N\mu_i}{\pi\epsilon_0}$$

Or

$$E_i = E + \frac{1.2P}{\pi\epsilon_0} = E + \frac{\gamma P}{\epsilon_0}$$

Here γ depends on the internal structure and its value for a cubic symmetry is $1/3$. So the above equation reduces as:

$$E_i = E + \frac{P}{3\epsilon_0} \quad (10.19)$$

The above equation for field is called Lorentz field.

10.8 CLAUSIUS MOSSOTTI RELATION

The clausius-mossotti expresses the dielectric constant of a material in terms of atomic polarizability of a material constituting atoms molecules or a homogeneous mixture. The Clausius-Mossotti equation was developed by Italian physicist Ottaviano Fabrizio Mossotti in 1863. He used macroscopic electrostatics for the formation of the equation. Later in 1870, a German physicist Rudolf Clausius developed this theory independently in 1879. The equation gives a relation between dielectric constant ϵ of a material and the polarizability of the atoms. It is best followed by gases and liquids and solids follow it approximately. In dielectric solids, the atoms and molecules experience externally applied electric field. The dipole also produces the internal electric field. Both the electric fields give rise to a resultant electric field which is termed as local electric field or internal field. In other words, local electric field is the field that is applicable on a dipole inside the solid locally.

The induced dipole moment is given by:

$$\vec{p}_{in} = \alpha \vec{E}_{local} \quad (10.20)$$

where α is the polarizability of atom or molecule (electronic). Atom will only exhibit electronic polarizability whereas molecule can have electronic, ionic and dipolar polarizability.

For a parallel plate capacitor, let E_0 be the field of the free charges on the conducting plates and E_1 be the field of bound charges on the surface of the dielectric (depolarized field). Suppose we take out a spherical shaped cavity of dielectric from capacitor. E_2 and E_3 are the field of the bound charges on the surface and inside the cavity respectively.

Local electric field will be:

$$\vec{E}_{local} = \vec{E}_{macroscopic} + \frac{\vec{p}}{3\epsilon} \quad (10.21)$$

Polarization for linear dielectric, $\vec{p} = \epsilon_0 \chi \vec{E}_{mac}$

$$\vec{p} = \epsilon_0 (\epsilon_r - 1) \vec{E}_{mac}$$

$$\text{Put in (10.21), } \vec{E}_{local} = \vec{E}_{mac} + \frac{\epsilon_0 (\epsilon_r - 1) \vec{E}_{mac}}{3\epsilon} \quad (10.22)$$

$$\boxed{\vec{E}_{\text{local}} = \frac{(\epsilon_r + 2) \vec{E}_{\text{mac}}}{3}} \quad (10.23)$$

If the molecule is kept in vacuum, then $\epsilon_r = 1$

$$\vec{E}_{\text{local}} = \frac{(1+2) \vec{E}_{\text{mac}}}{3} = \vec{E}_{\text{mac}}$$

$$\vec{E}_{\text{macroscopic}} = \vec{E}_{\text{local}}$$

but if the molecule is kept in solid, $\vec{E}_{\text{macroscopic}} < \vec{E}_{\text{local}}$

$$\text{from (10.20): } \vec{p}_{\text{in}} = \alpha \vec{E}_{\text{local}}$$

if N is the atomic or molecular density

$$\vec{P} = N \vec{p}_{\text{in}} = N\alpha \vec{E}_{\text{local}}$$

$$\epsilon_0 (\epsilon_r - 1) \vec{E}_{\text{mac}} = N\alpha \frac{(\epsilon_r + 2) \vec{E}_{\text{mac}}}{3}$$

$$\epsilon_0 (\epsilon_r - 1) = N\alpha \frac{(\epsilon_r + 2)}{3}$$

$$\boxed{\frac{N\alpha}{3\epsilon_0} = \frac{(\epsilon_r + 2)}{(\epsilon_r - 1)}} \quad (10.24)$$

This is Clausius Mossotti relation. This equation provides a link between a microscopic quantity (the polarizability) and a macroscopic quantity (the dielectric constant).

Limiting case: at visible frequency or 10^{14} Hz frequency,

Let α_e and α_i be the electronic and ionic polarizability and n be the refractive index, then,

$$\alpha = \alpha_e + \alpha_i$$

$$\text{at } \alpha_i = 0, \alpha = \alpha_e \text{ and } \epsilon_r = n^2$$

the equation (10.24) becomes

$$\boxed{\frac{N\alpha_e}{3\epsilon_0} = \frac{(n^2 - 1)}{(n^2 + 2)}} \quad (10.25)$$

Equation (10.25) is the Lorentz relation.

10.9 FERROELECTRICS

Below a certain temperature it is found that some materials spontaneously acquire an electric dipole moment. These materials are called as ferroelectric materials or ferroelectrics. The temperature at which ferroelectric property of the material disappears is called as ferroelectric Curie temperature. Ferroelectric materials are anisotropic crystals which exhibit a hysteresis curve P versus E which can be explained by domain hypothesis.

Ferro electricity

Ferro electric materials are an important group not only because of intrinsic Ferro electric property, but because many possess useful piezo electric, birefringent and electro optical properties. The intrinsic Ferro electric property is the possibility of reversal or change of orientation of the polarization direction by an electric field. This leads to hysteresis in the polarization P , electric field E relation, similar to magnetic hysteresis (Figure 10.10). Above a critical temperature, the Curie Point T_c , the spontaneous polarization is destroyed by thermal disorder. The permittivity shows a characteristic peak at T_c .

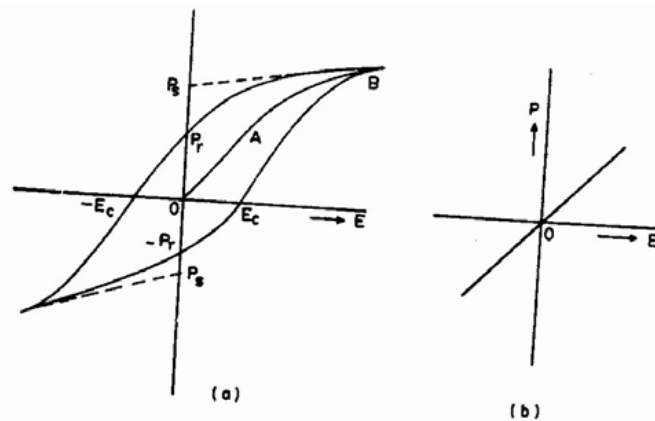

Figure 10.10: Ferroelectric Polarization

Basically ferroelectricity is a characteristic of certain materials that have a spontaneous electric polarization that can be reversed by the application of an external electric field. All ferroelectrics are pyroelectric with the additional property that their natural electrical polarization is reversible.

Examples

An important ferroelectric material for applications is lead zirconateTitanate (PZT), which is part of the sodium solution formed between ferroelectric Lead titanate and antiferroelectric Lead zirconate.

Apart of PZT, PbZr , TiO_3 , BaTiO_3 , PbTiO_3

- PbTiO_3 : Lead titanate
- PZT : Lead zirconate
- PLZT : Lead lanthanum zirconatetitanate

Applications of ferroelectric materials

Ferroelectric materials have a number of applications. Some of them are mentioned below:

1. Capacitors
2. Non-volatile memory
3. Piezoelectric for ultrasound imaging and actuators
4. Electro optic materials for data storage applications
5. Thermistors
6. switches known as trans charges or trans polarizers
7. Oscillators
8. Filters
9. Light detector
10. Modulators

10.10 ANTIFERROELECTRICITY

Antiferroelectricity is a physical property that is associated with antiferroelectric materials. These materials have ions which can polarize without external field (spontaneous polarization). As a result, dipoles are ordered or arranged with alternating orientation. That is, adjacent lines will be in anti-parallel direction. Electric field causes phase transition in these materials. This phase transition causes large pattern strain and energy change. Antiferroelectricity is highly linked to ferroelectricity. They are contrast with each other. So we have to know that ferroelectricity is also a physical property which polarizes quickly. By varying the direction of the field applied we can

invert the direction of polarization. So, the difference is the direction of dipoles after polarization. The former will align anti parallel and latter will align in the same direction (Figure 10.11). Antiferroelectric property is steady than ferroelectric property in a plain cubic pattern. The entire macroscopic spontaneous polarization in antiferroelectric material is zero. The reason is that the closest dipoles will cancel each other. This property can emerge or vanish depending on various parameters. The parameters are external field, pressure, growth method, temperature etc. The antiferroelectric property is not piezoelectric. That is there is no change in mechanical character of the material by the application of external field. These materials usually have high dielectric constant. The dipole orientation of this material is similar to the chess board pattern which is shown below:

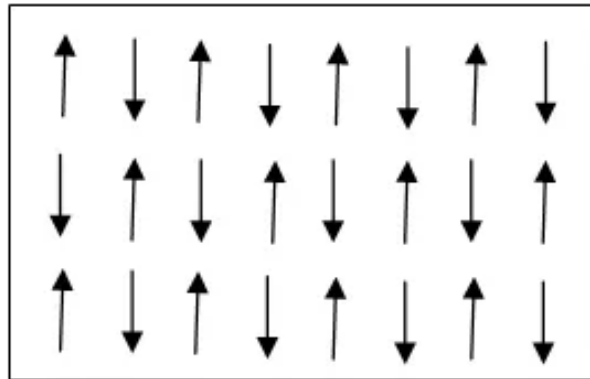

Figure 10.11: Arrangement of dipoles in the antiferroelectric material material with the application of electric field.

Examples

The examples of antiferroelectric materials are as follows

- PbZrO_3 (Lead Zirconate)
- $\text{NH}_4\text{H}_2\text{PO}_4$ (ADP: Ammonium dihydrogen Phosphate)
- NaNbO_3 (Sodium Niobate)

Antiferroelectricity and Temperature

The antiferroelectric property will vanish above a particular temperature. This we can call as Antiferroelectric Curie point. The materials and their curie temperature are shown in Table no.1. The dielectric constant (relative permittivity) less and more than this Curie point is investigated.

This is done for both first and second order transition. In the second order transition, dielectric constant is continuous all over the Curie point. In the two cases dielectric constant must not be very high.

Hysteresis loop of a perfect antiferroelectric material

The hysteresis loop of a perfect antiferroelectric material can be drawn as shown in Figure 10.12. The reversal of spontaneous polarization of these materials gives a double hysteresis loops. The external field applied is a low frequency AC field.

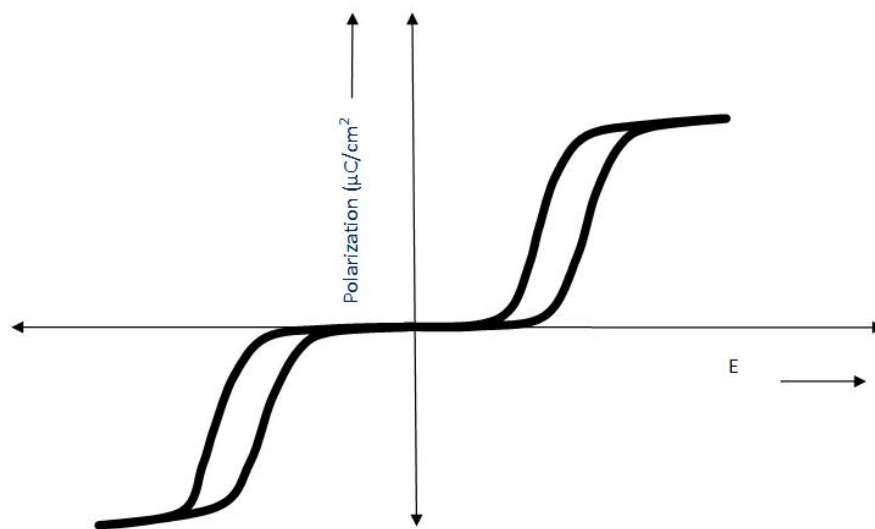

Figure 10.12: Hysteresis loop of a perfect antiferroelectric material.

Application of Antiferroelectricity

- Super capacitors
- MEMS Application
- Used in integration with ferromagnetic materials
- High energy storage devices
- Photonic application
- Liquid crystal etc.

10.11 PIEZOELECTRICITY

Piezoelectricity or piezoelectric effect is the ability of certain materials to generate an electric charge in response to applied mechanical stress. The word piezoelectric is derived from Greek word piezein means to squeeze or press. One of the unique characteristics of the piezoelectric effect is that it is reversible that is the materials exhibiting the direct piezoelectric effect also exhibit the Converse Piezoelectric effect. When piezoelectric material is placed in under mechanical stress a shifting of positive and negative charge centres in the material takes place which then results in an external electric field. When reversed and out electrical field that stretches or compresses the piezoelectric material. The piezoelectric effect is useful within many applications that involve the production and detection of sound generation of high voltages electronic frequency generation micro balances and ultrafine focusing of optical assemblies. It is also the basis of a number of scientific instrumental techniques with atomic resolution such as the scanning probe microscopes. This effect also has its use in more mundane application as well, such as acting as the ignition source for cigarette lighters.

Piezoelectric materials:

There are a number of materials both natural and manmade that exhibit a range of piezoelectric effects. Some naturally piezoelectric occurring materials includes berlinite (structurally identical to quartz) Cane sugar rock salt Topaz tormaline and bone. An example of manmade piezoelectric material includes barium titanate and lead zirconatetitanate.

Working

In a piezoelectric crystal, the positive and negative electrical charges are separated, but symmetrically distributed. This makes the crystal electrically neutral. Each of these sides forms an electric dipole and dipoles near each other tend to be aligned in regions called “Weiss domains”. The domains are usually randomly oriented, but can be aligned during poling, a process by which a strong electric field is applied across the material, usually at elevated temperatures. When a mechanical stress is applied, this symmetry is disturbed, and the charge asymmetry generates a voltage across the material. In Converse piezoelectric effect, application of an electrical field creates mechanical deformation in the crystal.

The most common application of piezo crystals to generate a potential is the electric cigarette lighter. Pressing the button of the lighter causes a spring-loaded hammer to hit a piezoelectric crystal, producing a sufficiently high voltage that electric current flows across a small spark gap, thus heating and igniting the gas. Some substances like quartz can generate potential differences of thousands of volts through direct piezo electric effect.

Applications

The Piezo effect finds many applications such as the production and detection of sound, generation of high voltages, electronic frequency generation, microbalances, and ultra-fine focusing of optical assemblies. It is also the basis of a number of scientific instrumental techniques with atomic resolution, the scanning probe microscopies and everyday uses such as acting as the ignition source for cigarette lighters and push-start propane barbecues. Some main applications of piezo crystals are:

- 1. High voltage and power sources:** An example of applications in this area is the electric cigarette lighter there pressing a button causes a spring loaded hammer to hit a piezoelectric crystal, thereby producing a sufficiently High Voltage that electric current flows across a small Spark gap, heating and igniting the gas. Most type of gas burners have a built in Piezo based injection system.
- 2. As Sensing elements:** Principle of operation of a piezoelectric sensor is that a physical dimension, transformed into force acts on two opposing surfaces of the sensing element.
- 3. Ultrasound imaging:** Piezoelectric sensors are used with high frequency sound in ultrasonic transducers for medical imaging. For many sensing techniques, the sensor can act as both a sensor and an actuator. Ultrasonic transducers, for example, can inject ultrasound waves into the body, receive the returned wave, and convert it to an electrical signal (a voltage).
- 4. Sonar sensors:** Piezoelectric elements are also used in the detection and generation of sonar waves. Applications include power monitoring in high power applications such as medical treatment, sonochemistry and industrial processing etc.
- 5. Chemical and biological sensors:** Piezoelectric microbalances are used as very sensitive chemical and biological sensors. Piezo are also used as strain gauges.
- 6. In Music instruments:** Piezoelectric transducers are used in electronic drum pads to detect the impact of the drummer's sticks.

7. Automotive application: Automotive engine management systems use a piezoelectric transducer to detect detonation by sampling the vibrations of the engine block. Ultrasonic piezo sensors are used in the detection of acoustic emissions in acoustic emission testing.

8. Piezo resistive silicon devices: The Piezo resistive effect of semiconductors has been used for sensor devices employing all kinds of semiconductor materials such as germanium, polycrystalline silicon, amorphous silicon, and single crystal silicon. Since silicon is today the material of choice for integrated digital and analog circuits the use of Piezo resistive silicon devices has been of great interest. It enables the easy integration of stress sensors with Bipolar and CMOS circuits.

9. Piezoresistors: Piezoresistors are resistors made from a Piezo resistive material and are usually used for measurement of mechanical stress. They are the simplest form of Piezo resistive device.

10.12 SUMMARY

In the present unit, we have understood that polarization is caused by the movement of electrons or ions or molecules from their equilibrium positions and is frequency dependent. This is because the mass of each entity is different and hence time scales are different. Basically, there are four polarization mechanisms: electronic, ionic, dipolar or orientation and interface and each of these mechanisms is characterized by different polarizability. The net polarizability of a solid will be sum of these four polarizabilities. We have also learnt that the local field inside a dielectric is not the same as the applied electric field. This field is a result of various microscopic and macroscopic fields inside the dielectric. This leads to derivation of Clausius-Mossotti equation which relates the microscopic dielectric properties to the macroscopic dielectric properties. In the last section we have understand the concept of ferroelectrics antiferroelectricity, and piezoelectricity.

10.13 GLOSSARY

Dipole	a pair of equal and oppositely charged or magnetized poles separated by a distance
Dielectric	a nonconducting substance; insulator

Voltage	electromotive force or potential difference expressed in volts
Polarize	to cause polarization in
Ferroelectric	pertaining to a substance that possesses spontaneous electric polarization such that the polarization can be reversed by an electric field
Piezoelectricity	electricity, or electric polarity, produced by the piezoelectric effect
Sensor	a mechanical device sensitive to light, temperature, radiation level, or the like, that transmits a signal to a measuring or control instrument
Polarization	The action of restricting the vibrations of a transverse wave, especially light, wholly or partially to one direction.

10.14 REFERENCES

1. Dielectric phenomena in solids, Kwan Chi Kao, Elsevier Academic Press.
2. Solid State Physics, A. J. Dekker, Printed in USA.
3. Solid State Physics, S. O. Pillai, New Age International Publishers.
4. Solid State Physics, Puri and Babbar.

10.14 SUGGESTED READING

1. Solid State Physics by R. K. Puri & V. K. Babbar
2. Solid State Physics by N. David
3. Solid State Physics 6th Edition by S.O. Pillai
4. Introduction to solid state physics by Charles Kittel

10.15 TERMINAL QUESTIONS

Multiple Choice Questions:

Question 1. The unit of dipole moment is _____

- A. coulomb. Metre
- B. coulomb/metre
- C. coulomb. metre²
- D. metre / coulomb

Question 2. The unit of dielectric constant is

- A. farad / metre
- B. unitless
- C. farad .metre
- D. farad . metre²

Question 3. The unit of Polarizability is

- A. farad / metre²
- B. farad metre²
- C. farad / metre
- D. Farad .metre

Question 4. The unit of Electric Susceptibility is

- A. coulomb. Metre
- B. coulomb/metre
- C. farad. metre²
- D. unit less

Question 5. The dielectric constant is ----- of the material.

- A. absolute permeability
- B. permittivity
- C. absolute permittivity
- D. permeability

Question 6. The unit of Polarization is

- A. coulomb. metre³
- B. coulomb/metre²
- C. coulomb. Metre
- D. metre / coulomb

Question 7. 1 Debye = ----- coulomb. Metre

- A. 3.33×10^{-12}
- B. 3.33×10^{-13}
- C. 3.33×10^{-3}
- D. 3.33×10^{-30}

Question 8. The value of relative permittivity for air is

- A. 1
- B. 1.6
- C. 1.66
- D. 1.8

Question 9. The following is not the type of polarization

- A. orientation
- B. ionic
- C. orbital
- D. electronic

Question 10. Piezoelectric effect is when materials produce electric charges when

- A. Voltage is applied
- B. Mechanical Stress is applied
- C. Electric field is applied
- D. Magnetic field is applied

Question 11. Piezoelectricity means _____

- A. Electric polarization
- B. Electric dielectric
- C. Pressure electricity
- D. Polar dielectric

Question 12. The piezoelectric materials used for converting energy are called as

- A. Transition Devices
- B. Converter
- C. Dielectric
- D. Transducer

Question 13. Piezoelectric effect is _____

- A. Isotropic
- B. Anisotropic
- C. Large in Magnitude
- D. Dominating

ANSWERS:

1. A, 2. A, 3. B, 4. D, 5. B, 6. B, 7. D, 8. A, 9. C, 10. B, 11. C, 12. D, 13. B,

Short Answer type questions

1. What do you mean by dielectric constant?
2. What is antiferroelectricity?
3. What is piezoelectricity?
4. What do you understand by local field?

5. Explain the main characteristics of the ferroelectric crystals?
6. Explain different type of polarizability?
7. What are the uses of piezoelectric effect?
8. Write Clausius –Mossotti equation.
9. Is Clausius –Mossotti equation valid for a gas dielectric?
10. What is the role of dielectric in capacitors?
11. What do you mean by orientational polarization? Discuss the temperature dependence of orientational polarization.

Long Answer type questions

1. Deduce the expression for the local field for structures possessing cubic symmetry.
2. Obtain Clausius-Mosotti equation and explain how it can be used to determine the dipole moment of a polar molecule from dielectric measurement.
3. What do you mean by polarisation in the dielectrics? Deduce the relation between dielectric constant and polarisability.
4. Write down the uses of ferroelectric crystals.
5. Briefly describe electronic polarizability?
6. Explain the various dielectric polarisation mechanism. How does it vary with frequency?
7. Obtain an expression for Lorentz field in a dielectric material and hence derive the Clausius-Mosotti equation.
8. What is the limitation for Clausius-Mossotti relation? Is that applicable for all the crystal structure?
9. What are dielectrics? Explain different types of polarization mechanisms and their frequency dependence with suitable diagrams
10. Define internal field. Derive an expression for the same for an array of dipoles in one dimension. Express Lorentz field for 3D array of dipoles.
11. Write a Short note: (a) dielectric strength, (b) antiferroelectricity, (c) Ferroelectricity, (d) Piezoelectricity.

Numerical Type questions

1. Compute the dielectric susceptibility of a material of dielectric constant 6.19.
2. Calculate the electronic polarizability of a material of dipole moment 0.04×10^{-18} Cm induced by an electric field of 50 V/m.
3. What is the internal electric field in a gas substance subjected to an electric field of 20V/m?

Structure

11.1 Introduction

11.2 Objectives

11.3 Dielectric function of Electron gas

11.4 Plasma Oscillations and Plasmon

11.5 Plasma in metals

11.6 Electrostatics screening

11.7 Polaritons and LST relation

11.8 Electron electron interaction

11.9 Electron phonon Interaction

11.10 Summary

11.11 Glossary

11.12 References

11.13 Suggested Readings

11.14 Terminal Questions

11.1 INTRODUCTION

Plasma is one of the four fundamental states of matter, first systematically studied by Irving Langmuir in the 1920s. It consists of a gas of ions – atoms or molecules which have one or more orbital electrons stripped and free electrons. In case of solids, according to free electron model, free electron gas oscillates with respect to ion core. This free electron gas, especially in case of metals where a large number of free electrons are available is considered as plasma. Dielectric function $\epsilon(\omega, K)$ strongly depends on frequency and wave vector, is used to explain the oscillations. The physical properties of solids depend on plasma oscillations. The plasma oscillations are quantized and the quantum of oscillations is called Plasmon. Plasmons can be described as an oscillation of electron density (free electrons of solid) with respect to the fixed positive ions in a metal. To visualize a plasma oscillation, imagine a cube of metal placed in an external electric field pointing to the right. Electrons will move to the left side (uncovering positive ions on the right side) until they cancel the field inside the metal. If the electric field is removed, the electrons move to the right, repelled by each other and attracted to the positive ions left bare on the right side. They oscillate back and forth at the plasma frequency until the energy is lost in some kind of resistance or damping. In this unit we will understand the different aspects of plasma oscillations and its interaction with crystal lattice, electron, phonon and photons.

11.2 OBJECTIVE

After studying this unit, you should be able to-

- Understand the Dielectric function of Electron gas
- Plasma Optics and Plasmon
- Electrostatics screening
- Polaritons
- LST relation
- Electron-electron interaction
- Electron- phonon Interaction

11.3 DIELECTRIC FUNCTION OF ELECTRON GAS

Dielectric function of electron gas is an angular frequency and wave vector based complex function $\epsilon(\omega, k)$ which is useful to explain the optical and transport properties of solids. The interaction between metal and light of semiconductor and light is determined by dielectric function of free electrons. If $k = 0$, dielectric function becomes $\epsilon(\omega)$ which describe the collective oscillation of electron gas with respect to ion core. This is called Plasmon system and the longitudinal oscillation

quanta are called Plasmons. In another case if $\omega = 0$; the dielectric function becomes $\epsilon(k)$; system is defined by electrostatic screening.

11.3.1 Dielectric Constant

Dielectric constant or relative permittivity of a medium is define as the ratio of absolute permittivity of a medium to absolute permittivity of free space ($K = \epsilon_r = \epsilon/\epsilon_0$). In term of electric field (E), electric displacement vector (D) and polarization vector (P) the dielectric constant is given as

$$\mathbf{D} = \epsilon_0 \mathbf{E} + \mathbf{P} = \epsilon \mathbf{E} = \epsilon_0 \epsilon_r \mathbf{E} \quad (1)$$

If ρ is total charge density given by the sum of internal charge density and induced charge density then

$$\rho = \rho_{ext} + \rho_{ind} \quad (2)$$

Using Maxwell's equations

$$\begin{aligned} \text{div } \mathbf{D} &= \text{div } \epsilon \mathbf{E} = \rho_{ext} \\ \text{div } \mathbf{E} &= \frac{\rho}{\epsilon_0} = \frac{\rho_{ext} + \rho_{ind}}{\epsilon_0} \end{aligned} \quad (3)$$

Now in terms of vector the relation among the quantities D, E, ρ, φ are given as

$$\mathbf{D}(\mathbf{K}) = \epsilon(\mathbf{K}) \mathbf{E}(\mathbf{K}) \quad (4)$$

11.4 PLASMA OSCILLATIONS AND PLASMON

Plasma oscillation in a solid especially in metals is collective excitations of free electron gas. The oscillations are quantised and the Plasmon is the quantum of plasma oscillations. It is assumed that in such oscillations the ion core is fixed and the free electron gas oscillates as collective longitudinal excitation. We can follow the classical electrodynamics approach to determine the dielectric constant. We assume that there is no any external electric field or any perturbation. Consider a free electron gas in a metal in two dimensions as shown in figure 11.1.

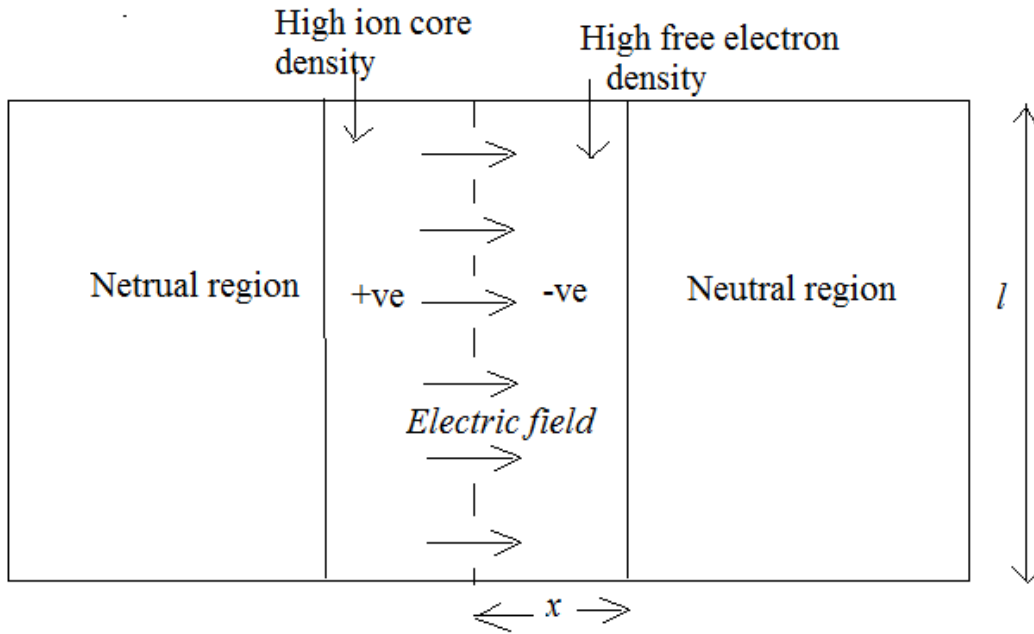

Figure 11.1: Electric field in a small region of two dimensional Plasma

In equilibrium position the, two positively and negatively charge density regions are created. In such region the charge neutrality is destroyed however the specimen as whole is neutral. We can calculate the frequency of plasma oscillations. Let us consider a small area da of in the charge distribution region with enclosed surface S having total charge q then from Gauss law

$$\oint_S E \cdot da = \frac{q}{\epsilon_0} \quad (5)$$

Where E is electric field. For two dimensional case, if l is the width of chosen region as shown in figure 11.1 the surface integral can be calculated as

$$\oint_S E \cdot da = -lE \quad (6)$$

Thus $\frac{q}{\epsilon_0} = lE$ or $E = \frac{q}{\epsilon_0 l}$

We know that in terms of electron concentration, charge per unit area N_0 , total charge q can be given as

$$q = -lxN_0e$$

Thus $E = \frac{N_0e x}{\epsilon_0} \quad (7)$

This electric field is responsible for oscillation of electron gas. The equation of motion of a free electron in an electric field can be given as

$$m \frac{d^2x}{dt^2} = -eE \quad (8)$$

Using eq. 7

$$\frac{d^2x}{dt^2} = -\left(\frac{N_0 e^2}{\epsilon_0 m}\right) x \quad (9)$$

This is the equation in terms of simple harmonic oscillation where the acceleration is proportional to negative of displacement ($a = -\omega^2 x$). Thus the characteristic frequency of plasma oscillation can be given as

$$\omega_P = \left(\frac{N_0 e^2}{\epsilon_0 m}\right)^{1/2} \quad (10)$$

The ω_P is known as plasma frequency. In presence of external electric field x and E have time dependent oscillation in the form of $e^{-i\omega t}$.

If
$$x = x_0 e^{-i\omega t}$$

Differentiate this equation two times and put in eq. 8

$$\begin{aligned} \frac{d^2x}{dt^2} &= -\omega^2 x_0 e^{-i\omega t} = -\omega^2 x = -eE \\ x &= -eE/m\omega^2 \end{aligned} \quad (11)$$

In this case the electrons also acquires dipole moments $-ex$ and bulk polarisation P i.e. dipole moment per unit volume can be given as

$$\begin{aligned} P &= -N_0 ex \\ P &= -\left(\frac{N_0 e^2}{m\omega^2}\right) E \end{aligned} \quad (12)$$

From eq. 1 the dielectric function $\epsilon(\omega, 0)$ or $\epsilon(\omega)$ at frequency ω can be given as

$$\epsilon(\omega) = \frac{\mathbf{D}(\omega)}{\epsilon_0 \mathbf{E}(\omega)} = \frac{\epsilon_0 \mathbf{E}(\omega) + \mathbf{P}(\omega)}{\epsilon_0 \mathbf{E}(\omega)} = 1 + \frac{\mathbf{P}(\omega)}{\epsilon_0 \mathbf{E}(\omega)}$$

or
$$\epsilon(\omega) = \frac{\mathbf{D}(\omega)}{\epsilon_0 \mathbf{E}(\omega)} = 1 + \frac{\mathbf{P}(\omega)}{\epsilon_0 \mathbf{E}(\omega)} \quad (13)$$

Putting the value of P from eq. 12

$$\epsilon(\omega) = 1 - \frac{N_0 e^2}{\epsilon_0 m \omega^2} \quad (14)$$

$$\epsilon(\omega) = 1 - \frac{\omega_P^2}{\omega^2} \quad (15)$$

From the eq. (15) it is clear that if frequency ω matches with the characteristic frequency of plasma oscillation ω_p , the dielectric function (constant) becomes 0. This condition is referring to longitudinal plasma oscillations. In this condition the electron gas oscillates as a whole with respect to ion core. The energy of oscillations is quantised and energy quanta $\hbar\omega_p$ is called Plasmon.

11.5 PLASMA IN METALS

In metallic solids there are a large number of free electrons. These free electrons can be excited by providing energy from external sources. The plasma oscillations in the metal are nothing but collective longitudinal excitations of free electrons gas. Plasmon is the quantum of energy associated with oscillations of electron gas.

Now we will find out the potential variation in terms of length for metal plasma. Consider a metallic crystal with volume charge density ρ . If δN is the change in electron concentration due to fluctuation in charge density then resulting charge density at a point can be given as

$$\rho' = \rho - e\delta N \quad (16)$$

From Poisson's equation

$$\nabla^2 V = \frac{1}{\epsilon_0} (\rho - e\delta N) \quad (17)$$

According to classical statistics change in electron concentration δN can be given by

$$\delta N = N_0 \left[\exp \frac{eV}{kT} - 1 \right] \quad (18)$$

Where N_0 is number of electron concentration at equilibrium. If kT is very small than excitation energy of electron gas than above expression can be given as

$$\delta N \approx N_0 \frac{eV}{kT}$$

Putting this value in eq. (17) we will get

$$\nabla^2 V = \frac{1}{\epsilon_0} \left(\rho - eN_0 \frac{eV}{kT} \right)$$

$$\nabla^2 V + \frac{e^2 N_0}{\epsilon_0 kT} V = \frac{\rho}{\epsilon_0}$$

Let $\frac{e^2 N_0}{\epsilon_0 kT} = \left(\frac{1}{\lambda_D} \right)^2$ the equation becomes

$$\nabla^2 V + \left(\frac{1}{\lambda_D} \right)^2 V = \frac{\rho}{\epsilon_0}$$

This is second order differential equation and its solution can be given as

$$V = \frac{\rho}{r} e^{-r/\lambda_D} \quad (19)$$

λ_D is known as Debye length.

11.5.1 Experimental Setup for Creating Plasmon in Metals

We can excite a Plasmon in a metal by passing a high energy electron in a thin sheet or by reflection of electrons from the metals, or reflection of photons from the surface of a metal as shown in figure 11.2 and 11.3. The charge of the electron, interact with the electrostatic field fluctuations of plasma oscillations of free electron gas. After reflection or transmitted the electron loses its energy equal to integer multiplication of Plasmon energy. Table 1 shows the observed and calculated values of excite the collective plasma oscillation in dielectric materials also.

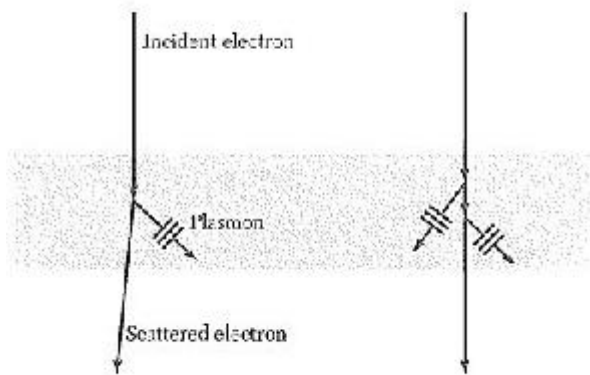

Figure 11.2: Creation of Plasmon in a metal film

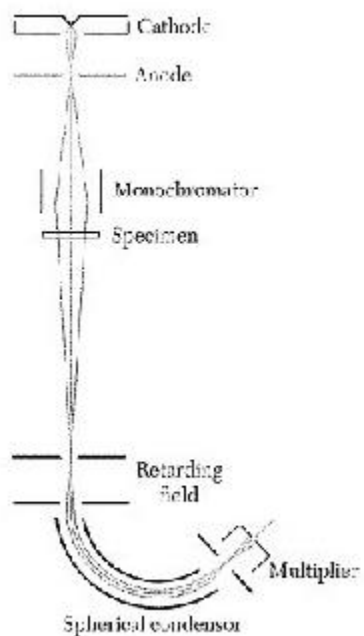

Figure 11.3: Experimental setup for Plasmon excitations

Table 11.1: Volume Plasmon energies of different materials

Type of material	Materials	Plasmon energies (eV)	
		Observed	Calculated $\hbar\omega_p$
Metals	Li	7.12	8.02
	Na	5.71	5.95
	Mg	10.6	10.9
	Al	15.3	15.8
Dielectrics	Si	16.4-16.9	16
	Ge	16.0 – 16.4	16

11.6 ELECTROSTATIC SCREENING

In physics, screening is the damping of electric fields caused by the presence of mobile charge carriers. It is an important part of ionized gases as classical plasmas, electrolytes, charge carriers in electronic conductors, semiconductors and metals. In a plasma, with a given permittivity ϵ , composed of electrically charged constituent particles, each pair of particles (with charges q_1 and q_2) interact through the Coulomb force as

$$F = \frac{1}{4\pi\epsilon} \frac{q_1 q_2}{r^2} \hat{\mathbf{r}} \quad (20)$$

where the vector \mathbf{r} is the relative position between the charges. This interaction complicates the theoretical treatment of the plasma. The difficulty lies in the fact that even though the Coulomb force diminishes with distance as $1/r^2$, the average number of particles at each distance r is proportional to r^2 , assuming the plasma is fairly isotropic. As a result, a charge fluctuation at any one point has non-negligible effects at large distances. In reality, these long-range effects are suppressed by the flow of particles in response to electric fields. This flow reduces the *effective* interaction between particles to a short-range "screened" Coulomb interaction.

In solid-state physics, especially for metals and semiconductors, the screening effect describes the electrostatic field and Coulomb potential of an ion inside the solid. Like the electric field of the nucleus is reduced inside an atom or ion due to the shielding effect, the electric fields of ions in conducting solids are further reduced by the cloud of conduction electrons.

Consider a plasma or fluid composed of electrons moving in a uniform background of positive charge (one-component plasma). Each electron possesses a negative charge. According to Coulomb's interaction, negative charges repel each other. Consequently, this electron will repel other electrons creating a small region around itself in which there are fewer electrons. This region can be treated as a positively charged "screening hole". Viewed from a large distance, this screening hole has the effect of an overlaid positive charge which cancels the electric field produced by the electron. Only at short distances, inside the hole region, can the electron's field be detected. If the background is made up of positive ions, their attraction by the electron of interest reinforces the above screening mechanism. In plasma physics, electric-field screening is also called Debye screening or shielding.

The screened potential determines the inter atomic force and the phonon dispersion relation in metals. The screened potential is used to calculate the electronic band structure of a large variety of materials, often in combination with pseudopotential models. The screening effect leads to the independent electron approximation, which explains the predictive power of introductory models of solids like the Drude model, the free electron model and the nearly free electron model.

Theory:

Consider a plasma or fluid of electrons in a background of heavy, positively charged ions. For simplicity, we ignore the motion and spatial distribution of the ions, approximating them as a uniform background charge. This simplification is permissible since the electrons are lighter and more mobile than the ions, provided we consider distances much larger than the ionic separation.

Screened Coulomb interactions:

Let ρ denote the number density of electrons, and ϕ the electric potential. At first, the electrons are evenly distributed so that there is zero net charge at every point. Therefore, ϕ is initially a constant as well.

We now introduce a fixed point charge Q at the origin. The associated charge density is $Q\delta(r)$, where $\delta(r)$ is the Dirac delta function. After the system has returned to equilibrium, let the change in the electron density and electric potential be $\rho(r)$ and $\phi(r)$ respectively. The charge density and electric potential are related by Poisson's equation, which gives

$$\nabla^2[\phi(r)] = \frac{1}{\epsilon_0} [Q\delta(r) - e\rho(r)] \quad (21)$$

where ϵ_0 is the vacuum permittivity.

To proceed, we must find a second independent equation relating ρ and ϕ . We consider two possible approximations, the Debye–Hückel approximation, valid at high temperatures (e.g. classical plasmas), and the Thomas–Fermi approximation, valid at low temperatures (e.g. electrons in metals). We use Thomas–Fermi approximation.

Thomas–Fermi approximation:

In the Thomas–Fermi approximation, the system is maintained at a constant electron chemical potential (Fermi level) and at low temperature. The former condition corresponds, in a real experiment, to keeping the metal/fluid in electrical contact with a fixed potential difference with ground. The chemical potential μ is, by definition, the energy of adding an extra electron to the fluid. This energy may be decomposed into a kinetic energy T part and the potential energy $-e\phi$ part. Since the chemical potential is kept constant. Thus

$$\Delta\mu = T - e\Delta\phi \quad (22)$$

Or
$$\mu = \epsilon_F(x) - e\phi \quad (23)$$

If the temperature is extremely low, the behavior of the electrons comes close to the quantum mechanical model of a Fermi gas. We thus approximate T by the kinetic energy of an additional electron in the Fermi gas model, which is simply the Fermi energy ϵ_F .

Thomas–Fermi Screening:

The static screening can be described by the wave vector dependence of the static dielectric function $(0, K)$. We consider an electron gas of charge concentration $-n_0e$ superimposed on a positive ion core of charge $+n_0e$.

The Poisson eq. can be given as

$$K^2\phi_{ext}(K) = 4\pi\rho_{ext}(K) \quad (24)$$

The total charge density is given as

$$\rho = \rho_{ind}(K) + \rho_{ext}(K) \quad (25)$$

using Poisson eq.

$$K^2\phi(K) = 4\pi\rho(K) \quad (26)$$

Now the total chemical potential of the electron gas is constant in equilibrium at any point. In a region where there is no any electrostatic contribution the chemical potential is given as

$$\mu = \epsilon_F = \frac{\hbar^2}{2m} (3\pi^2 n_0)^{3/2} \quad (27)$$

Using approximation as given in eq. 23, the total chemical potential is given as

$$\mu = \epsilon_F(x) - e\phi = \frac{\hbar^2}{2m} (3\pi^2 n(x))^{3/2} - e\phi \cong \frac{\hbar^2}{2m} (3\pi^2 n_0)^{3/2} \quad (28)$$

At approximation $q \ll k_F$ the Taylor series expansion of eq. 28 can be given as

$$\frac{d\epsilon_F}{dn_0} [n(x) - n_0] \cong e\phi(x) \quad (29)$$

Differentiate eq.27

$$\frac{d\epsilon_F}{dn_0} = \frac{2\epsilon_F}{3n_0}$$

Now eq. 29 becomes

$$\begin{aligned} \frac{2\epsilon_F}{3n_0} [n(x) - n_0] &\cong e\phi(x) \\ [n(x) - n_0] &= \frac{3}{2} n_0 \frac{e\phi(x)}{\epsilon_F} \end{aligned} \quad (30)$$

In this equation, the left hand side is nothing but induced part of electron concentration. Thus the Fourier component (induced part) of this eq. can be given as

$$\rho_{ind}(K) = -ne = -\frac{3}{2} n_0 \frac{e^2 \phi(x)}{\epsilon_F} \quad (31)$$

Now eq. 26 becomes

$$\rho_{ind}(K) = -\frac{6\pi n_0 e^2}{\epsilon_F K^2} \rho(K) \quad (32)$$

We know that if $\rho(K)$ is total charge density then $\rho(K) = \rho_{ext} + \rho_{ind}$ and dielectric function can be given as

$$\epsilon(K) = \frac{\rho_{ext}}{\rho(K)} = 1 - \frac{\rho_{ind}(K)}{\rho(K)}$$

Putting the value of $\rho_{ind}(K)$ from eq. (32)

$$\begin{aligned} \epsilon(K) &= 1 - \frac{\rho_{ind}(K)}{\rho(K)} = 1 + \frac{6\pi n_0 e^2}{\epsilon_F K^2} \\ \epsilon(K) &= 1 + \frac{K_s^2}{K^2} \end{aligned} \quad (33)$$

where K_s is Thomas–Fermi screening wave vector and given as

$$K_s = \frac{6\pi n_0 e^2}{\epsilon_F} \quad (34)$$

The expression is called Thomas –Fermi dielectric function and $1/K_s$ is called Thomas –Fermi screening length. For copper its value is 0.55Å. By using some more rearrangements, the eq. 34 can also be written as

$$K_s = \frac{6\pi n_0 e^2}{\epsilon_F} = 4 \left(\frac{3}{\pi}\right)^{1/3} n_0^{1/3} / a_0 = 4\pi e^2 D(\epsilon_F) \quad (35)$$

Where a_0 is Bohr radius and $D(\epsilon_F)$ is density of states for free electron gas.

11.7 POLARITONS

Polaritons are quasiparticles resulting from strong coupling of electromagnetic waves with an electric or magnetic dipole-carrying excitation. Polaritons describe as the interaction of transverse optical phonon and transverse electromagnetic (Phonon-photon coupling). Thus the quantum of coupled phonon- photon transverse wave interaction is called Polariton. A major feature of polaritons is a strong dependency of the propagation speed of light through the crystal on the frequency of the photon. In figure 11.4 shows Dispersion relation of phonon polaritons in GaP. Red curves are the uncoupled phonon and photon dispersion relations, black curves are the result of coupling (from top to bottom: upper polariton, LO phonon, lower polariton).

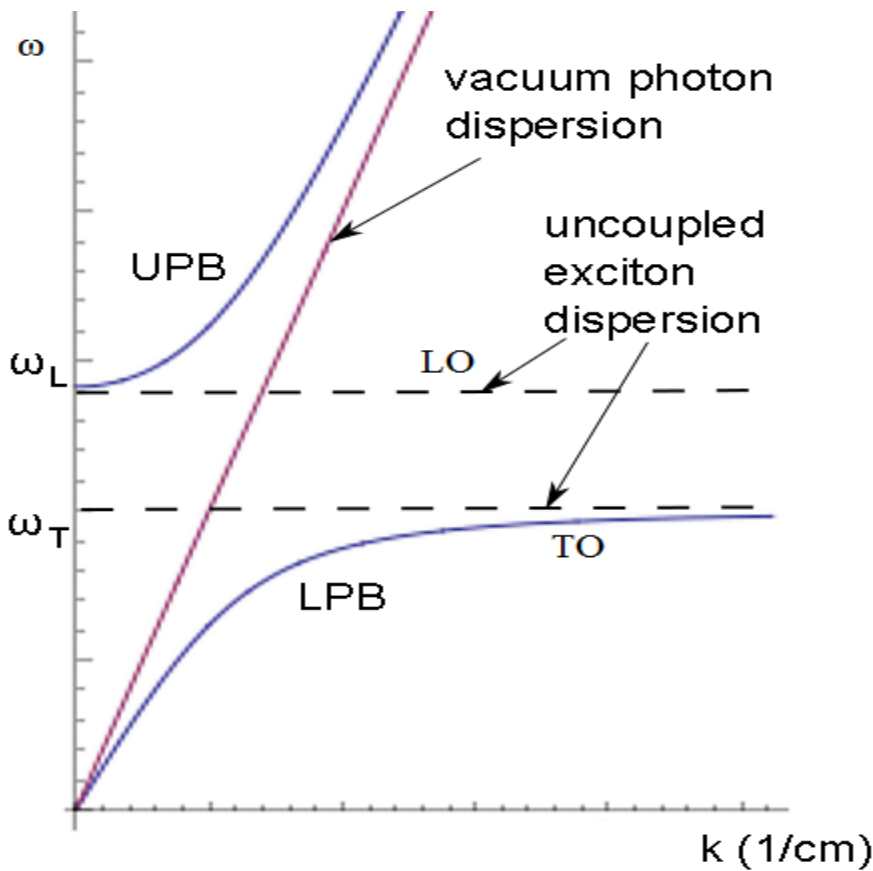

Figure 11.4: dispersion relation for photon and transverse optical phonon.

According to classical theory of electronic polarisation when an electron cloud is displaced from its original position, the electron cloud exhibits simple harmonic motion which tends to restore its original position. The differential equation of motion is given as

$$m \frac{d^2x}{dx^2} + \beta x = 0 \quad (36)$$

Where β is force constant. The characteristic frequency of this oscillatory motion of electron gas or resonance frequency can be given as

$$m\omega_0^2 = \beta$$

If an alternating field is applied, then the force acting on the electron can be given as

$$m \frac{d^2x}{dx^2} + \beta x = eE_0 e^{i\omega t} \quad (37)$$

The solution of this type of differential equation is given as

$$x = \frac{e}{m} \frac{E_0 e^{i\omega t}}{\omega_0^2 - \omega^2} \quad (38)$$

The induced dipole moment in the system can be given as

$$p = e \cdot x = \frac{e^2}{m} \frac{E_0 e^{i\omega t}}{\omega_0^2 - \omega^2} \quad (39)$$

As we know that the electronic polarizability α_e is define as dipole moment per unit electric field ($p = \alpha_e E$) thus from above equation electronic polarizability can be given as

$$\alpha_e = \frac{e^2}{m} \frac{1}{\omega_0^2 - \omega^2} \quad (40)$$

If there are more than one absorption frequencies or number of harmonic oscillators, then above equation can be modified as summation of all frequencies thus

$$\alpha_e = \frac{e^2}{m} \sum_j \frac{1}{\omega_0^2 - \omega^2} \quad (41)$$

We know the Clausius- Mossotti equation is

$$\frac{\epsilon_r - 1}{\epsilon_r + 2} = \frac{1}{3\epsilon_0} \sum_j N \alpha_j \quad (42)$$

Using this equation with an approximation $\epsilon_r + 2 \approx 3$ and putting the value of

$$\epsilon_r - 1 = N \frac{e^2}{m\epsilon_0} \sum_j \frac{1}{\omega_0^2 - \omega^2} \quad (43)$$

On simplifying for an atom

$$\epsilon_r(\omega) = 1 + \frac{Ne^2}{m\epsilon_0} \frac{1}{\omega_0^2 - \omega^2} \quad (44)$$

This equation give the dielectric function which is function of ω and its value ranges from 0 to ∞ and given as

$$\epsilon_r(\omega) = \epsilon_r(\infty) + \frac{\omega_T^2}{\omega_T^2 - \omega^2} [\epsilon_r(0) - \epsilon_r(\infty)] \quad (45)$$

Above eq.45 Shows that the electromagnetic wave will not propagate in a forbidden range define as $\omega_T^2 < \omega < \omega_L^2$. Here ω_T is TO phonon frequency in the absence of coupling. The ω_L is define as

$$\omega_L^2 = \omega_T^2 \frac{\omega_L^2 - \omega^2}{\omega_T^2 - \omega^2} \quad (46)$$

Putting the values of ω_L^2 eq. 45 becomes

$$\epsilon_r(\omega) = \epsilon_r(\infty) \frac{\omega_L^2 - \omega^2}{\omega_T^2 - \omega^2} \quad (47)$$

Thus the wave does not propagate in the frequency range ω_T and ω_L . In this region $\epsilon_r(\omega)$ becomes negative. The zero of $\epsilon_r(\omega)$ give the above relation eq. 47 as

$$\epsilon_r(0) = \epsilon_r(\infty) \frac{\omega_L^2}{\omega_T^2} \quad (48)$$

$$\frac{\omega_L^2}{\omega_T^2} = \frac{\epsilon_r(0)}{\epsilon_r(\infty)} \quad (49)$$

The relation given in eq. 49 is called Lyddane-Sachs-Teller (LST) relation. In this relation $\epsilon_r(0)$ is called static dielectric constant and $\epsilon_r(\infty)$ is called high frequency limit of dielectric function.

11.8 ELECTRON-ELECTRON INTERACTIONS

In free electron gas or Fermi gas is a system of non-interacting electrons. The same system of interacting electrons is called Fermi liquid.

11.8.1 Fermi Liquid

Fermi liquid theory is a theoretical model of interacting fermions that describes the normal state of most metals at sufficiently low temperatures. The phenomenological theory of Fermi liquids was introduced by the Soviet physicist Lev Davidovich Landau in 1956, using diagrammatic perturbation theory. The effect of electron-electron interaction is described by this theory. The theory explains why some of the properties of an interacting fermion system are very similar to those of the ideal Fermi gas (i.e. non-interacting fermions), and why other properties differ. Important examples of where Fermi liquid theory has been successfully applied are most notably electrons in most metals and liquid helium-3. Liquid helium-3 is a Fermi liquid at low

temperatures. Helium-3 is an isotope of helium, with 2 protons, 1 neutron and 2 electrons per atom. Because there are an odd number of fermions inside the nucleus, the atom itself is also a fermion. The electrons in a normal metal also form a Fermi liquid and these electrons suffer collisions.

Landau's theory explains the low lying single particle excitations of the system of interacting electrons. These single particle excitations of electron gas are called quasiparticles. A quasiparticle may be considered as a single particle accompanied by a distortion cloud in the electron. This type of interactions may change the effective mass of the electron in Fermi liquid system.

11.8.2 Electron – Electron Collision

In metals the conduction electrons are roughly 2 Å apart but electrons travel long distance between collisions with each other. The mean free path is in order of 10^4 Å at room temperature, and 10cm at 0K. Two factors are responsible for such large value of free path, one is exclusion principle and other is screening of the coulomb interactions between two electrons. We can see the exclusion principle reduces the collision frequency of electron that has low excitation energy outside the filled Fermi sphere.

11.9 ELECTRON–PHONON INTERACTION (POLARONS)

A polaron is a quasiparticle condensed matter physics to understand the interactions between electrons and phonon (atomic vibrations in a solid material). The polaron concept was proposed by Lev Landau in 1933 and Solomon Pekar in 1946 to describe an electron moving in a dielectric crystal where the atoms displace from their equilibrium positions to effectively screen the charge of an electron, known as a phonon cloud. The results of polaron theory are lowering the electron mobility and increase the electron's effective mass. This occurs because the electrons drag the heavy ion core along with it. The general concept of a polaron has been extended to describe other interactions between the electrons and ions in metals that result in a bound state, or a lowering of energy compared to the non-interacting system. This is still an active field of research to find exact numerical solutions to the case of one or two electrons in a large crystal lattice, and to study the case of many interacting electrons.

Experimentally, polarons are important to the understanding of a wide variety of materials. The electron mobility in semiconductors can be greatly decreased by the formation of polarons. Organic semiconductors are also sensitive to polaronic effects, which is particularly relevant in the design of organic solar cells that effectively transport charge. Polarons are also important for interpreting the optical conductivity of these types of materials. Figure 11.5 shows the electron and ion core interaction in a semiconductor solid. The electron is repelled by another electron and attracted by ion core. The electron phonon interaction can also be seen in the temperature dependence of the electric resistivity of a metal say copper, as it is 1.55micro ohm at 0°C and becomes 2.28micro ohm at 100°C. This occurs due to electron phonon interaction in the crystal. As temperature increases more phonon are there and more scattering which result increase in resistivity.

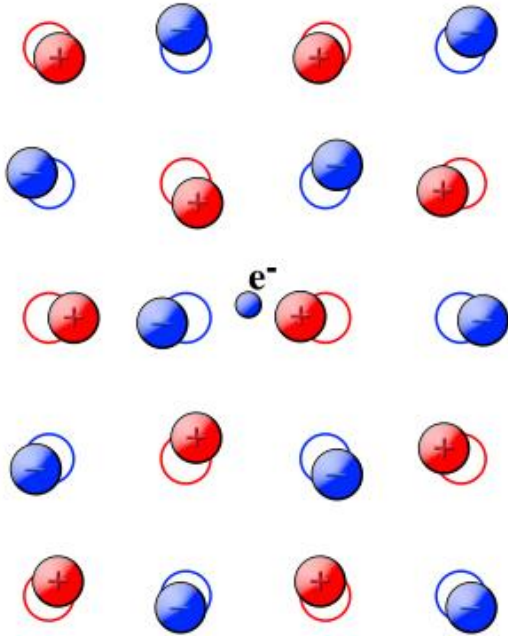

Figure 11.6: Formation of Polaron in a semiconductor crystal

The effect is large in ionic crystal as the coulomb interaction is large between electron and ions. However, in covalent crystals the effect is weak. The strength of electron-lattice interaction is measured by a dimensionless constant α called Fröhlich coupling constants and given as

$$\frac{1}{2}\alpha = \frac{\text{deformation energy}}{\hbar\omega_L}$$

Where ω_L is longitudinal optical phonon frequency near zero wavevector. $\frac{1}{2}\alpha$ can be understand as number of phonons which surround a slow moving electrons in the crystal. The value of effective mass of polaron m_{pol}^* can be given as

$$m_{pol}^* \cong m^* \left(\frac{1 - 0.008\alpha^2}{1 - \frac{1}{6}\alpha + 0.0034\alpha^2} \right)$$

Where m^* is effective mass calculated by band theory of solids. Table 11.2 shows the values of α , and effective mass of polaron m_{pol}^*

Table: 11.2

Material	α	m_{pol}^*/m	m^*/m
InSb	0.023	0.014	0.014
AgBr	1.53	0.33	0.24
KBr	3.05	0.93	0.43
KCl	3.44	1.25	0.50
AgCl	1.84	0.51	0.35

ZnO	0.85		
GaAs	0.06		

11.10 SUMMARY

1. Plasmons can be described as an oscillation of electron density (free electrons of solid) with respect to the fixed positive ions in a metal.
2. Dielectric function of electron gas is an angular frequency and wave vector based complex function $\epsilon(\omega, k)$ which is useful to explain the optical and transport properties of solids.
3. If $k = 0$, dielectric function becomes $\epsilon(\omega)$ which describe the collective oscillation of electron gas with respect to ion core. This is called Plasmon system and the longitudinal oscillation quanta are called Plasmons.
4. In another case if $\omega = 0$; the dielectric function becomes $\epsilon(k)$; system is defined by electrostatic screening.
5. In term of electric field (E), electric displacement vector (D) and polarization vector (P) the dielectric constant is given as

$$D = \epsilon_0 E + P = \epsilon E = \epsilon_0 \epsilon_r E$$

6. Dielectric function is also define as

$$\epsilon(\omega, K) = \frac{\rho_{ext} E(\omega, K)}{\rho_{ext}(\omega, K) + \rho_{ind}(\omega, K)}$$

7. Plasma Frequency or characteristic frequency of plasma oscillation can be given as

$$\omega_P = \left(\frac{N_0 e^2}{\epsilon_0 m} \right)^{1/2}$$

$$\epsilon(\omega) = 1 - \frac{\omega_P^2}{\omega^2}$$

8. The pole of dielectric function is defined as plasma ω_T and zeroes define as ω_L .
9. Thomas–Fermi screening wave vector and given as

$$K_s = \frac{6\pi n_0 e^2}{\epsilon_F}$$

10. $1/K_s$ is called Thomas –Fermi screening length.
11. Polaritons describe as the interaction of transverse optical phonon and transverse electromagnetic (Phonon-photon coupling).
12. Lyddane-Sachs-Teller (LST) relation is given as

$$\frac{\omega_L^2}{\omega_T^2} = \frac{\epsilon_r(0)}{\epsilon_r(\infty)}$$

In this relation $\epsilon_r(0)$ is called static dielectric constant and $\epsilon_r(\infty)$ is called high frequency limit of dielectric function.

13. Fermi gas is a system of non-interacting electrons. The same system of interacting electrons is called Fermi liquid. Landau's theory explains the low lying single particle excitations of the system of interacting electrons. These single particle excitations of electron gas are called

quasiparticles. A quasiparticle may be considered as a single particle accompanied by a distortion cloud in the electron. This type of interactions may change the effective mass of the electron in Fermi liquid system.

14. A polaron is a quasiparticle due to the interactions between electrons and phonon (atomic vibrations in a solid material). The results of polaron theory are lowering the electron mobility and increase the electron's effective mass in solids.

15. The strength of electron-lattice interaction is measured by a dimensionless constant α called Fröhlich coupling constants and given as

$$\frac{1}{2}\alpha = \frac{\text{deformation energy}}{\hbar\omega_L}$$

11.11 GLOSSARY

Plasma: collective excitations of free electron

Polaritons: Phonon-photon coupling

Fermi liquid: system of interacting fermions.

Polaron: Quasiparticle which are quanta of interaction between electrons and phonon

11.12 REFERENCES

1. Charles Kittel, Introduction to Solid State Physics, Wiley Eastern Limited 5th ed. 1976
2. H. C. Gupta, Solid State Physics, Vikas Publishing House Private Limited 1995
3. A. J. Dekkar, Solid State Physics, The Macmillan Press Ltd. 1981

11.13 SUGGESTED READINGS

1. J. Callaway, Quantum Theory of the Solid State, Part A & B, Academic Press, New York (1974)
2. R. Kubo and T. Nagamiya, Solid State Physics, McGraw-Hill, New York (1969). 1992
3. Uichiro Mizutani, Introduction to the Electron Theory of Metals, Cambridge University Press, 2014.

11.14 TERMINAL QUESTIONS

11.14.1 Short answer type questions

1. What do you mean by Plasma? Define the Plasmon.

2. What do you mean by Dielectric function of electron gas?
3. Define Dielectric function of electron gas.
4. How the Plasmon can be created in metals?
5. What is electrostatic screening?
6. What are polaritons?
7. Define Fermi liquid. How can we achieve a Fermi liquid.
8. Define Polaron.

11.14.2 Long answer type questions

1. Find out the expression for plasma frequency.
2. Define Thomas- Fermi screening and find out the expression for Thomas –Fermi screening length.
3. Derive Lyddane-Sachs-Teller (LST) relation. Define static dielectric constant and high frequency limit of dielectric function.
4. Define electron phonon interaction and Fröhlich coupling constants.

UNIT 12 DIAMAGNETISM AND PARAMAGNETISM

Structure:

12.1 Introduction

12.2 Objectives

12.3 Basic definitions

12.4 Magnetic Moment

12.5 Classification of magnetism

12.6 Diamagnetism

 12.6.1 Classical theory of Diamagnetism

12.7 Paramagnetism

 12.7.1 Classical theory of Paramagnetism

 12.7.2 Weiss theory of Paramagnetism

 12.7.3 Quantum theory of Paramagnetism

12.8 Summary

12.9 Glossary

12.10 References

12.11 Suggested readings

12.12 Terminal questions

12.1 INTRODUCTION

Magnetism begins with a mineral called magnetite (Fe_3O_4), which is abundant the rock-type lodestone. These magnets were used by the ancient peoples as compasses to guide sailing vessels. However, the first study of magnetism was made by William Gilbert. He published a book “On the magnet” in 1600. Magnetism is a physical phenomenon in which certain materials exert an attracting or repellent force or influence on other materials. In the current idea, all materials, regardless of their nature, are said to show magnetic.

When a substance is placed in a magnetic field H substance gets magnetized. The magnetic moment per unit volume M is produced inside the substance M is called magnetization. The relation between magnetization and magnetic field is given as below:

$$M = \chi_m H$$

χ_m is a constant and known as magnetic susceptibility of the material and defined as the ratio of magnetization M and magnetic field intensity H . The value of χ_m for vacuum is zero because there is no magnetization in vacuum.

In this unit we shall discuss the various types of magnetic materials and their characteristics. We shall also discuss the different theories of diamagnetism and paramagnetism in detail.

12.2 OBJECTIVES

After studying this unit, you should be able to-

- Differentiate the paramagnetic and diamagnetic materials.
- Define Magnetic moment, Susceptibility etc.
- Understand the Classical theory of paramagnetism.
- Define Curie Law for paramagnetism.
- Understand the Weiss theory of paramagnetism.
- Understand the Quantum theory of paramagnetism

12.3 BASIC DEFINITIONS

Magnetic field

The magnetic field is the area in which a magnet's magnetic effect can be felt. Magnetic lines of force radiate from the North Pole, pass through the surrounding medium, and then re-enter the South Pole to constitute the magnetic field.

Magnetic flux (ϕ)

Magnetic flux is the total number of magnetic lines of forces travelling through a surface. It is represented by symbol (ϕ) it, and the unit is weber (Wb).

Magnetic flux density (or) Magnetic induction (B)

Magnetic flux density (B) is defined as the magnetic flux (ϕ) passing normally through unit area of cross section at that point. The unit is Wb/m² or tesla.

$$\text{Thus } B = \frac{\phi}{A}$$

Magnetic field intensity (H)

Magnetic field intensity at any point in a magnetic field is the force experienced by a unit North Pole placed at that point. It is denoted by H and its unit is N/Wb.

Relation between B , H and M

A magnetic field can be expressed in terms of Magnetic field intensity (H) and Magnetic flux density. In free space, these quantities are related as

$$B = \mu_0 H$$

In a magnetic material, above relation is written as

$$B = \mu H$$

Here μ_0 = absolute permeability of free space, μ = absolute permeability of the medium and $\mu/\mu_0 = \mu_r$ = relative permeability of the magnetic material.

Magnetization (M)

Magnetization is defined as magnetic moment per unit volume and expressed in ampere/meter. It is proportional to the applied magnetic field intensity (H). It is measured in Amperes per meter (am^{-1}).

$$M = \chi H$$

Here, χ is the Magnetic susceptibility.

$$B = \mu_0(H+M) \quad (12.1)$$

12.4 MAGNETIC MOMENT (μ_m)

Magnetism in materials is normally described as mutual attraction between two pieces of a material, say iron or iron ore. There are various microscopic mechanisms of magnetism in materials which are shown later. The strength of magnetism is quantitatively judged by a quantity called as ‘magnetic moment’.

Origin of magnetic moments

The major contributors of magnetic moment in a material are:

- **Due to the orbital motion of electrons:** Motion of electrons in an orbit of an atom. Orbital moment can be related to the current flowing in a loop of a wire of zero (negligible) resistance.
- **Due to the spin of the electrons:** Spinning of electron around its own spin axis gives rise to a moment.
- **Due to the spin of the nucleus:** Nuclear magnetic moment due to nuclei.

The first two contributions are quite significant and contribute to most of the magnetic character of a material while the third component, nuclear magnetic moment, is rather insignificant in the context of most magnetic materials of practical interest and can be neglected.

12.5 CLASSIFICATION OF MAGNETISM

A material is magnetically characterized based on the way it can be magnetized. Basically it depends on the material's magnetic susceptibility (its magnitude and sign).

There are normally three basic magnetisms:

- Diamagnetism
- Paramagnetism
- Ferromagnetism

Anti ferromagnetism and ferrimagnetisms are considered as subclasses of ferromagnetism.

Diamagnetism

Applied external field acts on atoms of a material, slightly unbalancing their orbiting electrons, and creates small magnetic dipoles within atoms which oppose the applied field. This action produces a negative magnetic effect known as diamagnetism. It is a very weak effect in nature and exists only in presence of an external field, and non-permanent. Magnetic susceptibility for these materials is negative, and is in order of -10^{-5} . Cu, Ag, Si, Ag and alumina are some common examples of diamagnetic materials at room temperature.

Paramagnetism

In the absence of an external field, the orientations of atomic magnetic moments are random leading to no net magnetization. When an external field is applied dipoles line-up with the field, resulting in a positive magnetization. Paramagnetism is a slightly stronger than diamagnetism. Paramagnetic materials exhibit a small positive magnetic susceptibility in the presence of a magnetic field. Para-magnetism is produced in many materials like aluminium, calcium, titanium, alloys of copper. Magnetic susceptibility of these materials is slightly positive, and lies in the range $+10^{-5}$ to $+10^{-2}$.

Ferro-magnetism

Both dia and para magnetic materials are considered as non-magnetic because they exhibit

magnetization only in presence of an external field. Certain materials possess permanent magnetic moments even in the absence of an external field. This is result of permanent unpaired dipoles formed from unfilled energy levels. These dipoles can easily line-up with the imposed magnetic field due to the exchange interaction or mutual reinforcement of the dipoles.

Materials with ferromagnetism (Examples: Fe, Co, Ni, Gd) possess magnetic susceptibilities approaching 10^6 .

Comparison of Diamagnetic and Paramagnetic materials

S. No.	Diamagnetic Material	Paramagnetic Material
1.	Dipoles oriented in such a way that the resultant dipole moment is zero.	1. Dipoles are randomly oriented in such a way that the resultant dipole moment is not equal to zero.
2.	When the material is placed in the magnetic field the magnetic flux lines are repelled away from the material.	2. When the material is placed in the magnetic field the magnetic flux line pass through the material.
3.	Susceptibility is negative	3. Susceptibility is positive and small.
4.	Susceptibility is independent of temperature.	4. Susceptibility is independent of temperature.
5.	Permeability is less than one	5. Permeability is greater than one
6.	No spin or magnetic moment.	6. All spins are randomly oriented.
7.	When the temperature is less than the Curie temperature the diamagnetism suddenly disappears and the material becomes normal material	7. When the temperature is less than the Curie temperature the paramagnetic material is converted into diamagnetic material.

8. **Examples:** Hydrogen, Bismuth, Gold, water, germanium, silicon etc.,

8. **Examples:** Platinum, Aluminium, Chromium etc.,

12.6 DIAMAGNETISM

Diamagnetism is a weak magnetic effect that occurs in substances that do not have any permanent magnetic moments. Unpaired electrons do not exist in diamagnetic materials. Individual magnetic moments do not interact in these materials because electron spin moments cancel one other out (Figure 12.1). Because of their low, negative magnetic susceptibility, these materials are weakly repelled in a magnetic field. MgO, Cu, Ag, Au, are some examples of the diamagnetic materials. In diamagnetic compounds the electrons all have paired spins. In case of diamagnetism two electrons are paired together in an orbital, or their total spin is 0.

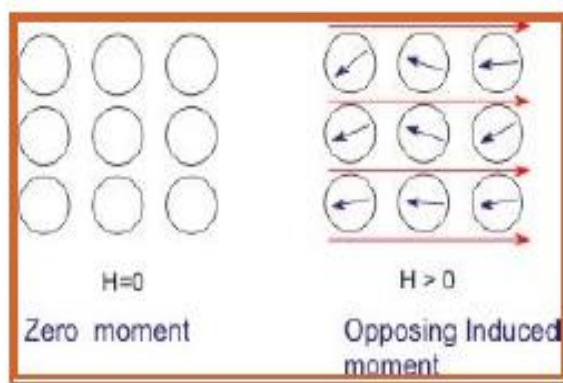

Figure 12.1: Representation of diamagnetic material in the absence of a magnetic field and in the presence of applied field. When magnetic field is applied, induced moments oppose the field.

12.6.1 Classical Theory of Diamagnetism

The theory of diamagnetism was first work out by Paul Langevin in 1905. Negative magnetism present in an applied field even though the material is composed of atoms that have no net magnetic moment.

Let us consider an electron revolves in the orbit of radius (r) about the nucleus of an atom is equivalent to a current and has magnetic moment. The electron revolves with an angular velocity ω_0 around nucleus of charge Ze . Then

$$\begin{aligned}
 F_0 &= \frac{mr^2 \omega_0}{r} = mr\omega_0^2 \\
 &= \frac{Ze^2}{4\pi\epsilon_0 r^2} \\
 \omega_0^2 &= \frac{Ze^2}{4\pi m\epsilon_0 r^3} \\
 \omega_0 &= \sqrt{\frac{Ze^2}{4\pi m\epsilon_0 r^3}} \tag{12.2}
 \end{aligned}$$

The magnetic moment of an electron is given as

$$M_L = iA = \frac{e}{T}(\pi r^2) = \frac{e\omega_0 r^2}{2} \tag{12.3}$$

The Lorentz force (F_L) that acts on the electron is:

$$F_L = -Bev = -Be\omega r \tag{12.4}$$

Now we can write the equation of motion as

$$F_0 - F_L = F_0 - F_L$$

On putting the value of F_0, F_L in the above equation,

$$F_m = \frac{Ze^2}{4\pi\epsilon_0 r^2} - Be\omega r$$

As we know that

$$\begin{aligned}
 F_m &= \frac{mv^2}{r} \\
 \frac{mv^2}{r} &= \frac{Ze^2}{4\pi\epsilon_0 r^2} - Be\omega r \\
 mr\omega^2 &= \frac{Ze^2}{4\pi\epsilon_0 r^2} - Be\omega r
 \end{aligned}$$

By simplifying the above equation, we will get;

$$\omega^2 = \frac{Ze^2}{4\pi m\epsilon_0 r^3} - \frac{Be\omega}{m}$$

$$\omega^2 + \frac{Be\omega}{m} = \frac{Ze^2}{4\pi m \epsilon_0 r^3}$$

Or

$$\omega^2 + \frac{Be\omega}{m} - \frac{Ze^2}{4\pi m \epsilon_0 r^3} = 0$$

By solving the equation we will get the values of ω as:

$$\omega = \left\{ -\frac{Be}{m} \pm \sqrt{\frac{B^2 e^2}{m^2} + \frac{4Ze^2}{4\pi m \epsilon_0 r^3}} \right\} \left(\frac{1}{2}\right)$$

$$= -\frac{Be}{2m} \pm \sqrt{\frac{B^2 e^2}{4m^2} + \frac{Ze^2}{4\pi m \epsilon_0 r^3}}$$

$$\omega = -\frac{Be}{2m} \pm \sqrt{\frac{B^2 e^2}{4m^2} + \omega_0^2} \quad (12.5)$$

$$\omega = \pm \omega_0 - \frac{Be}{2m} \text{ if } \frac{Be}{2m} \ll \omega_0 \quad (12.6)$$

This shows that the angular velocity of revolution of an electron changes by a factor of $\frac{eB}{2m}$ in the presence of magnetic induction B. this result is called the Larmor theorem.

The change in frequency produces as additional current I = charge \times revolution per unit time.

$$\begin{aligned} I &= -e \left(\frac{1}{2\pi} \frac{eB}{2m} \right) \\ &= \frac{e^2 B}{4\pi m} \end{aligned} \quad (12.7)$$

The corresponding change in the magnetic moment of the electron is

$$\Delta m = \text{current} \times \text{area}$$

On putting the value of I from the above equation.

$$\Delta m = \frac{e^2 B}{4\pi m} \times \pi r^2$$

On summing over all electrons in the atoms, the induced moment /atom becomes

$$\Delta m_{atom} = \frac{e^2 B \sum r^2}{4m}$$

Let Z be the number of electrons in the atom. Then,

$$\text{The magnetization } M = -\frac{Ze^2 B \sum r^2}{4m} \quad (12.8)$$

All the electron orbits are not oriented normal to the magnetic field hence r^2 in above equation replaced by $\frac{2}{3}r^2$

$$\therefore M = -\frac{Ze^2B \sum r^2}{6m}$$

For the solid consisting of N atom per unit volume,

The susceptibility of the material $\chi = \frac{M}{H} = -\frac{ZNe^2B \sum r^2}{6mH}$

We know that $B = \mu_0 H$

$$\begin{aligned} \chi &= -\frac{ZNe^2\mu_0 \sum r^2}{6m} \\ &= -\frac{e^2\mu_0}{6m} ZN \sum r^2 \end{aligned}$$

$$\chi = -\frac{e^2\mu_0}{6m} ZN \langle r^2 \rangle \tag{12.9}$$

This shows χ is independent of the field strength and temperature. This is called Langevin formula for volume susceptibility. This equation shows that susceptibility of a diamagnetic material is directly proportional to the atomic number and is independent of temperature.

χ for most of the diamagnetic substance is of the order 10^{-6} .

12.7 PARAMAGNETISM

Paramagnets have a small positive magnetisation M (directed parallel the applied field B). Each atom of paramagnetic material possesses a permanent non-zero net magnetic moment by virtue of incomplete cancellation of electron spin and/or orbital magnetic moments (Figure 12.2). Some examples of paramagnetic materials are Mg, Mo, Li etc. In the absence of an external magnetic field, the orientations of these atomic magnetic moments are random, but have small magnetic moment. The susceptibility of paramagnetic materials is usually very small 10^{-3} to 10^{-6} .

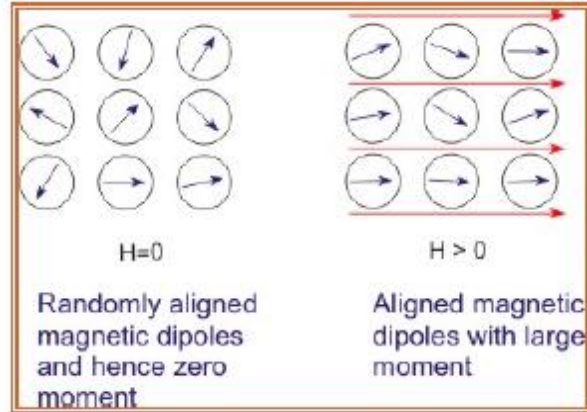

Figure 12.2: Representation of paramagnetic material in the absence of a magnetic field and in the presence of applied field. When magnetic field is applied, induced moments aligned magnetic dipoles with large moment.

12.7.1 Langevin's Theory of Paramagnetism

A paramagnetic material is one which when placed in a magnetic field becomes weakly magnetized in the same direction as the field. Langevin explained paramagnetism on the basis that the atoms or molecules of a paramagnetic material have a net intrinsic magnetic moment due to the spin and orbital motion of electrons in it. In the absence of magnetic field, a macroscopic amount of paramagnetic material is not magnetized because molecules are randomly oriented due to thermal vibrations so that the net magnetic moment of the specimen is zero.

When paramagnetic material is placed in an external magnetic field the molecule experience torque which tries to align them in the direction of the field. But the alignment is not complete because the thermal motion of the molecule which favors random orientation. The average alignment gives raise a net magnetic moment per unit volume in the direction of the field. If the temperature of the specimen is raised the magnetization becomes smaller due to the increase of thermal agitation.

Let us now calculate the net magnetic moment per unit volume produced by alignment of the molecules at certain temperature T (Figure 12.3). Suppose n be the number of molecules per unit volume of the specimen and θ the angle which the magnetic moment $\vec{\mu}_m$ of a molecule makes with the external magnetic field \vec{B} the potential energy of the molecule in the field is

$$U = -\mu_m B \cos \theta \quad (12.10)$$

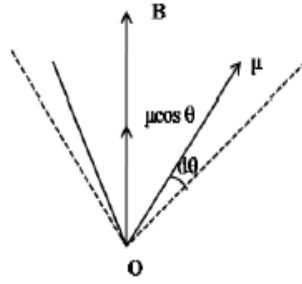

Figure 12.3

Statistically the number of molecules having energy U at a temperature T is proportional to $e^{-U/K_B T}$, where K_B is Boltzmann's constant. The number of molecules per unit volume dn , having energy U and oriented at angles between θ and $\theta + d\theta$ with respect to the direction of \vec{B} is given by

$$dn = C e^{-\frac{U}{K_B T}} d\omega \quad (12.11)$$

Where C is a constant and $d\omega$ is solid angle between two hollow cones of semi vertex angles θ and $\theta + d\theta$ and is given by

$$d\omega = 2\pi \sin \theta d\theta \quad (12.12)$$

substituting the value of U and $d\omega$ in equation (12.11) we get;

$$dn = C e^{\mu_m B \cos \theta / K_B T} 2\pi \sin \theta d\theta \quad (12.13)$$

or

$$dn = A e^{x \cos \theta} \sin \theta d\theta$$

where

$$x = \frac{\mu_m B}{K_B T}$$

and $A = C2\pi$ is a new constant. Integrating equation (12.13) from $\theta = 0$ to $\theta = \pi$, we get the total number of molecules per unit volume i.e.

$$n = A \int_0^\pi e^{x \cos \theta} \sin \theta d\theta \quad (12.14)$$

putting $\cos \theta = r$, $\sin \theta d\theta = -dr$ we have

$$\begin{aligned} n &= -A \int_1^{-1} e^{xr} dr \\ &= -A \left[\frac{e^{xr}}{x} \right]_1^{-1} \\ &= -\frac{A}{x} (e^{-r} - e^r) \\ &= \frac{A}{x} (e^r - e^{-r}) \end{aligned}$$

$$= \frac{2A}{x} (\sinh x) \quad (12.15)$$

Since each molecule of dn has a component of magnetic moment $\mu_m \cos \theta$ along the direction of magnetic field. Thus, the magnetic moment of dn molecules along the direction of magnetic field $\mu_m \cos \theta dn$. The total magnetic moment I along the direction of field due to all molecules per unit volume is given by

$$I = \int_0^\pi \mu_m \cos \theta dn \quad (12.16)$$

$$I = A\mu_m \int_0^\pi e^{x \cos \theta} \cos \theta \sin \theta d\theta \quad (12.17)$$

Assuming $\cos \theta = r$ so that $\sin \theta d\theta = -dr$ we have

$$I = -A\mu_m \int_1^{-1} r e^{rx} dr$$

$$\begin{aligned}
&= -A\mu_m \left[r \frac{e^{rx}}{x} - \int_1^{-1} \frac{e^{rx}}{x} dr \right]_1^{-1} \\
&= -A\mu_m \left[r \frac{e^{rx}}{x} - \frac{e^{rx}}{x^2} \right]_1^{-1} \\
&= -A\mu_m \left[\left\{ -\frac{e^{-x}}{x} - \frac{e^{-x}}{x^2} \right\} - \left\{ \frac{e^x}{x} - \frac{e^x}{x^2} \right\} \right] \\
&= \frac{A\mu_m}{x} \left[\left\{ e^{-x} + \frac{e^{-x}}{x} \right\} + \left\{ e^x - \frac{e^x}{x} \right\} \right] \\
&= \frac{A\mu_m}{x} \left[\{e^x + e^{-x}\} - \frac{1}{x} \{e^x - e^{-x}\} \right] \\
&= \frac{2A\mu_m}{x} \left[\cosh x - \frac{\sinh x}{x} \right]
\end{aligned}$$

Using, $\frac{2A}{x} = \frac{n}{\sinh x}$, we have

$$I = n\mu_m \left[\coth x - \frac{1}{x} \right] \quad (12.18)$$

$\left[\coth x - \frac{1}{x} \right]$ is termed as Langevin's function and is denoted by $L(x)$. Hence

$$I = n\mu_m L(x) \quad (12.19)$$

where

$$x = \frac{B\mu_m}{K_B T}$$

for small value of x the series expansion of $L(x)$ shows that

$$L(x) = \coth x - \frac{1}{x} \simeq \frac{x}{3} \quad (12.20)$$

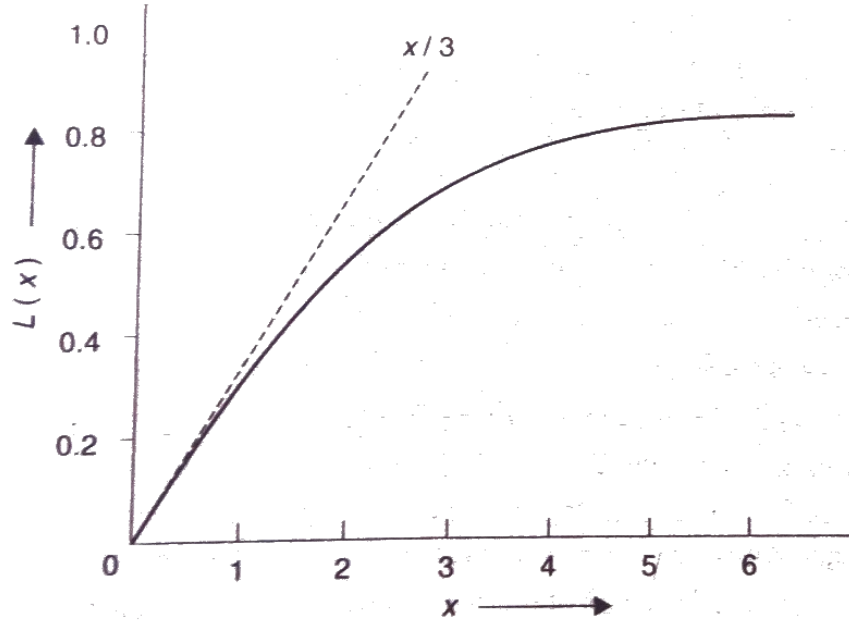

Figure 12.4: Variation of Langevin function with x .

So that

$$M = n\mu_m \frac{x}{3} = \frac{n\mu_m^2}{3K_B T} B \quad (12.21)$$

we know that $B = \mu_o(H + M)$, M is very small for paramagnetic substances hence $B = \mu_o H$. Then we have $M = \mu_o \frac{n}{3K_B T} H$

Since magnetization is a vector quantity, hence

$$\vec{M} = \mu_o \frac{n\mu_m^2}{3K_B T} \vec{H} \quad (12.22)$$

In paramagnetic materials \vec{M} and \vec{H} are in same direction. The magnetic susceptibility of a paramagnetic material is given by

$$\chi = \frac{\vec{M}}{\vec{H}} = \mu_o \frac{n\mu_m^2}{3K_B T} \quad (12.23)$$

$$\chi \propto \frac{1}{T} \quad (12.24)$$

Thus, for a paramagnetic material the magnetic susceptibility is inversely proportional to the absolute temperature (Figure 12.5). This relation is known as Curie's law.

Where $C = \mu_0 \frac{n\mu_m^2}{3K_B}$ is called Curie constant.

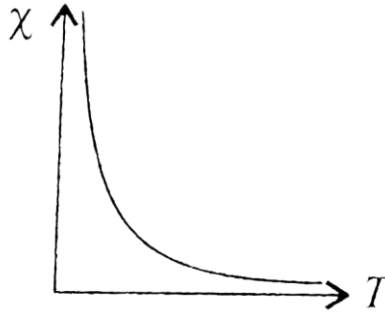

Figure 12.5: Variation of magnetic susceptibility of a paramagnetic material.

12.7.2 Weiss Theory of Paramagnetism

In order to remove the failures of Langevin theory, Weiss introduce the concept of internal molecular field. In real gas the molecules are mutually influenced by their magnetic moments and consequently there should exist within the gas a molecular field. This field produced at any point by all the neighbouring molecules is proportional to the intensity of magnetization.

The molecular field can be given as:

$$H_i = \lambda M \quad (12.25)$$

λ is known as molecular field coefficient. Hence the effective field (H_{eff}) can be given as;

$$H_{eff} = H + H_i \quad (12.26)$$

From Langevin theory of paramagnetism we know that

$$M = \frac{N\mu_m^2}{3K_B T} B \quad (12.27)$$

Since we know that $B = \mu_0 H$

Then the above equation 12.27 can be written as:

$$M = \frac{N\mu_m^2\mu_0 H_{eff}}{3K_B T} \quad (12.28)$$

$$M = \frac{N\mu_m^2\mu_0(H + H_i)}{3K_B T} \quad (12.29)$$

On putting the value of H_i in above equation 12.27:

$$M = \frac{N\mu_m^2\mu_0(H + \lambda M)}{3K_B T} \quad (12.30)$$

After rearranging the terms, we will modify the equation as:

$$M = \frac{N\mu_m^2\mu_0 H}{3K_B T} + \frac{N\mu_m^2\mu_0 \lambda M}{3K_B T}$$

Or

$$M - \frac{N\mu_m^2\mu_0 \lambda M}{3K_B T} = \frac{N\mu_m^2\mu_0 H}{3K_B T}$$

$$M \left[1 - \frac{N\mu_m^2\mu_0 \lambda}{3K_B T} \right] = \frac{N\mu_m^2\mu_0 H}{3K_B T} \quad (12.31)$$

Let us suppose $C = \frac{N\mu_m^2\mu_0}{3K_B}$ and $\theta = C\lambda$

On putting these values in the above equation 12.31, we will get:

$$M \left[1 - \frac{\theta}{T} \right] = \frac{CH}{T}$$

As we know that $\chi = \frac{\bar{M}}{H}$

$$\text{So } \chi = \frac{C}{\left[1 - \frac{\theta}{T} \right] T}$$

$$\text{Or } \chi = \frac{C}{T - \theta} \quad (12.32)$$

This equation is known as Curie Weiss law. $\theta = \frac{N\mu_m^2\lambda}{3K_B}$ is called paramagnetic Curie point. From this Curie Weiss law we can conclude that below paramagnetic Curie temperature ($T < \theta$) susceptibility becomes negative. However most of the paramagnetic substances Curie temperature is quite low.

12.7.3 Quantum Theory of Paramagnetism

Quantum theory assumes that the permanent magnetic moment of a given atom is limited to a finite set of orientations related to the applied field. Let N be the number of atom/m³.

$J=L+S$ (Total angular momentum quantum number of each atom)

$\mu_j = gM_j\mu_B$ is the magnetic moment of each atom.

M_j =magnetic quantum number = J, (J-1), (J-2),.....-(J-1), -J

According to statistical mechanics, the magnetization can be given as:

$$M = N \frac{\sum_{-j}^j gM_j\mu_B \exp(M_j\mu_B H\mu_0/K_B T)}{\sum_{-j}^j \exp(gM_j\mu_B H\mu_0/K_B T)} \quad (12.33)$$

At high temperature $\frac{gM_j\mu_B H\mu_0}{K_B T} \ll 1$

$$\exp\left(\frac{gM_j\mu_B H\mu_0}{K_B T}\right) = 1 + \frac{gM_j\mu_B H\mu_0}{K_B T} \quad (12.34)$$

By neglect higher order terms, the magnetization equation becomes as:

$$M = N \frac{\sum_{-j}^j gM_j\mu_B \left(1 + \frac{gM_j\mu_B H\mu_0}{K_B T}\right)}{\sum_{-j}^j \left(1 + \frac{gM_j\mu_B H\mu_0}{K_B T}\right)} \quad (12.35)$$

Or

$$M = N \left[\frac{\sum_{-j}^j gM_j\mu_B + \sum_{-j}^j \frac{g^2 M_j^2 \mu_B^2 \mu_0}{K_B T}}{\sum_{-j}^j 1 + \sum_{-j}^j \frac{gM_j\mu_B H\mu_0}{K_B T}} \right] \quad (12.36)$$

Substituting these values $\sum_{-j}^j M_j = 0$, $\sum_{-j}^j 1 = (2j + 1)$ and $\sum_{-j}^j M_j^2 = \frac{j(j+1)(2j+1)}{3}$.

equation 12.36 becomes

$$M = N \left[\frac{0 + \frac{Hg^2\mu_B^2\mu_0}{K_B T} X \frac{j(j+1)(2j+1)}{3}}{(2j+1)+0} \right] \quad (12.37)$$

$$= N \left[\frac{Hg^2\mu_B^2\mu_0}{K_B T} \right] X \frac{j(j+1)(2j+1)}{3}$$

$$= N \left[\frac{\left[\frac{Hg^2\mu_B^2\mu_0}{K_B T} \right] X \frac{j(j+1)(2j+1)}{3}}{(2j+1)+0} \right]$$

$$M = N \frac{Hg^2\mu_B^2\mu_0 \frac{j(j+1)}{3}}{K_B T}$$

$$M = \left[\frac{NHg^2\mu_B^2\mu_0}{K_B T} \right] \frac{j(j+1)}{3} \quad (12.38)$$

$$\text{Susceptibility } \chi = \frac{\bar{M}}{H} = \left[\frac{NHg^2\mu_B^2\mu_0}{K_B T H} \right] \frac{j(j+1)}{3}$$

$$= \frac{J(J+1) N g^2 \mu_B^2 \mu_0}{3 K_B T}$$

$$= \frac{N \mu_J^2 \mu_0}{3 K_B T} \quad (12.39)$$

$$\chi = \frac{C}{T}$$

Where, $\mu_J = g^2 J(J+1) \mu_B^2$

$$\mu_J = \mu_B \times g \sqrt{J(J+1)}$$

$$\mu_J = \mu_B \times P_{eff}$$

P_{eff} = Effective Bohr magneton

$$\chi = \frac{N P_{eff}^2 \mu_B^2 \mu_0}{3 K_B T} = \frac{C}{T} \quad (12.40)$$

For ground state of the atom $J=S$ and $L=3$. Hence the value of P_{eff} is $g\sqrt{S(S+1)}$.

12.8 SUMMARY

We concluded in this chapter that diamagnetism is a very weak magnetic effect. It can be seen in solids that do not have a permanent magnetic moment. Diamagnetism is present in all materials but the effect is so weak it is often neglected in comparison to paramagnetic and ferromagnetic effects. It is independent of temperature so heating a material will not change its diamagnetic susceptibility. Diamagnetism is possible in solids, liquids, and gases. The orbital motion of electrons causes the modest non-zero magnetic moment in these materials and magnetic moment is always in the opposite direction of the applied magnetic field. These materials do not obey Curie's law. Paramagnetism is a weak magnetic phenomenon in which the magnetic moments are aligned in the field directions, unlike diamagnetism. Magnetization of paramagnetic substances is inversely proportional to absolute temperature. The magnetization of paramagnetic substances is inversely proportional to absolute temperature. It means that if we increase the temperature, paramagnetic substances start losing their magnetic power.

12.9 GLOSSARY

Magnetic Induction, B	Flux per unit area of a section normal to the direction of the magnetic path.
Flux	This is the number of "magnetic lines of force".
Permanent Magnet	A magnet that retains its magnetic properties in the absence of an inducing field or current.
Magnetism	A class of physical phenomena that include being able to attract iron.
Magnet	It is any material that has a magnetic field.
Magnetic Field	The space around a magnet in which the magnetic force can be detected.
Magnetic Flux	The total magnetic induction across or through a specified area
Diamagnetic	Magnetic properties of materials that have lower permeability values to 1 (eg. Silver, copper, water, gold, lead, zinc ...).

Magnetic susceptibility

Magnetic susceptibility is the ability of a material to react to the action of a magnetic field

12.10 REFERENCES

1. Introduction to Solid state physics by Charles Kittel
2. Solid state physics by S.O. Pillai
3. Solid state physics by A.B. Gupta and Nurul Islam
4. Solid state physics by A.J. Dekker
5. Fundamentals of Solid state physics by B.S. Saxena, R.C. Gupta and P.N. Saxena
6. Elementary Solid state physics by Ali Omar

12.11 SUGGESTED READING

1. Introduction to magnetic materials, B.D. Cullity.
2. N. A. Spaldin, Magnetic Materials: Fundamentals and Device Applications. Cambridge University Press, 2003
3. S. O. Kasap, Principles of Electronic Materials and Devices. McGraw-Hill, 2006
4. R. E. Hummel, Electronic Properties of Materials. Springer New York, 2013. p. 337-378

12.13 TERMINAL QUESTIONS

QUESTIONS

1. What will be the change in diamagnetic susceptibility of Bismuth, if it is heated from 298 K to 650 K.
2. Can you calculate the diamagnetic susceptibility of single crystal HCP titanium using the classical Langevin model? Explain why or why not.
3. Why would doping a piece of silicon change its bulk magnetic susceptibility?
4. What happens in the bulk magnetic susceptibility of silicon, if we vary the temperature?

ANSWERS

1: Reason: The diamagnetic susceptibility has no dependence on temperature, so heating a material will not change its diamagnetic susceptibility.

2: No. The derivation of Langevin's susceptibility relies on the assumption that the material has a classically bound electron (rotating around an atom to create the magnetic moment), however, metals do not have localized electrons. Therefore, the substitutability cannot be determined using this theory.

3: The susceptibility depends on the number of contributing electrons surrounding an atom, Z . Doping silicon introduces atoms that have different valencies and thus changes the overall susceptibility contribution of atoms in the material.

4: By heating the material through different temperature regimes the electrons bound to their atoms can be freed, ionizing the donor atoms, such as in n-type silicon. The freed electrons populate the material at different temperatures (see: Extrinsic Semiconductors) making the susceptibility vary with temperature.

Short answer type questions

1. What do you mean by magnetic susceptibility?
2. Give some examples of diamagnetic substances.
3. Explain the term susceptibility and permeability in magnetic materials.
4. Define Curie Weiss law and its application.
5. Discuss the variation of temperature and susceptibility in paramagnetic substances.
6. Explain the origin of diamagnetism in free electron.
7. Explain the Langevin's theory of paramagnetism.
7. Explain the Langevin's theory of diamagnetism.
8. Write a short note on classification of magnetic materials.

Long Answer Type Questions

1. Discuss Langevin's theory of diamagnetism. Derive an expression for the change of magnetic moment.

2. Use angular momentum of processing electron in magnetic field to derive the magnetization of a sample and thus diamagnetic susceptibility.
3. What is the difference between diamagnetic and paramagnetic materials? Discuss the temperature and susceptibility variation in paramagnetic and diamagnetic substances in detail.
4. Discuss Langevin's theory of paramagnetism and derive an expression for paramagnetic susceptibility.

Multiple Choice Questions

1. Basic source of magnetism _____.

- (a) Charged particles alone
- (b) Movement of charged particles
- (c) Magnetic dipoles
- (d) Magnetic domains

2. Units for magnetic flux density

- (a) Wb / m^2
- (b) $\text{Wb} / \text{A.m}$
- (c) A / m
- (d) Tesla / m

3. Magnetic permeability has units as

- (a) Wb / m^2
- (b) $\text{Wb} / \text{A.m}$
- (c) A / m
- (d) Tesla / m

4. Magnetic permeability has units as

- (a) Tesla
- (b) Henry
- (c) Tesla / m
- (d) Henry / m

5. Magnetic field strength's units are

- (a) Wb / m^2
- (b) $\text{Wb} / \text{A.m}$

- (c) A / m
- (d) Tesla / m

6. Example for dia-magnetic materials

- (a) Super conductors
- (b) Alkali metals
- (c) Transition metals
- (d) Ferrites

7. Example for para-magnetic materials

- (a) Super conductors
- (b) Alkali metals
- (c) Transition metals
- (d) Ferrites

8. Example for ferro-magnetic materials

- (a) Super conductors
- (b) Alkali metals
- (c) Transition metals
- (d) Ferrites

9. Example for anti-ferro-magnetic materials

- (a) Salts of transition elements
- (b) Rare earth elements
- (c) Transition metals
- (d) Ferrites

10. Example for ferromagnetic materials

- (a) Salts of transition elements
- (b) Rare earth elements
- (c) Transition metals
- (d) Ferrites

11. Magnetic susceptibility para-magnetic materials is

- (a) $+10^{-5}$
- (b) -10^{-5}

- (c) 10^5
 (d) 10^{-5} to 10^{-2}

12. Magnetic susceptibility diamagnetic materials is

- (a) $+10^{-5}$
 (b) -10^{-5}
 (c) 10^5
 (d) 10^{-5} to 10^{-2}

13. Magnetic susceptibility ferro-magnetic materials is

- (a) $+10^{-5}$
 (b) -10^{-5}
 (c) 10^5
 (d) 10^{-5} to 10^{-2}

ANSWERS:

1. b ,2. a ,3. b ,4. d ,5. c ,6. b ,7. b ,8. c ,9. a ,10. d ,11. d ,12. b ,13. c

Numerical Type Questions:

- The susceptibility of a paramagnetic material at temperature 300K is 2×10^{-5} . At what temperature its susceptibility will increase to 2×10^{-5} . (**Answer: 200K**)
- Consider a He atom in its ground state. The mean radius of the atom is approximated by Bohr radius 0.53 \AA . The density of helium is 0.18 Kg/m^3 . Using Langevins formula calculate the diamagnetic susceptibility. (Atomic mass of the He atom $M=4.003 \times 10^{-3} \text{ Kg}$ and Avogadro's number $N_A= 6.023 \times 10^{23}$) (**Answer: -8.93×10^{-10}**)
- For the given value of Magnetic field $B= 1.6 \text{ T}$, Magnetic intensity= $H=1000 \text{ A/m}$, $\mu_0=4 \times 10^{-7} \text{ Wb/Am}$. Then calculate relative permeability, susceptibility? (**Answer: Relative permeability is 1273 and susceptibility is 1272**).
- The susceptibility of annealed iron at saturation is 5500. Find the permeability of annealed iron at saturation. (**Answer: Permeability at saturation is $6.9 \times 10^{-3} \text{ H/m}$**).
- A paramagnetic material has $10^{28} \text{ atoms/m}^3$. Its susceptibility at 350 K is 2.8×10^{-4} . Calculate the susceptibility at 300 K.

UNIT 13

FERROMAGNETISM

Structure

13.1 Introduction

13.2 Objectives

13.3 Types of magnetic materials

13.4 Ferromagnetism

13.4.1 Weiss Molecular Field theory in Ferromagnetic Material

13.4.2 Relation between T_c and λ

13.4.3 Temperature dependence of saturation magnetization

13.4.4 Paramagnetic region

13.5 Heisenberg's exchange interaction

13.6 Retentivity, coercivity and Hysteresis

13.7 Spin wave and Magnons

13.7.1 Quantization of spin wave

13.8 Antiferromagnetism

13.8.1 Molecular Field Theory of Antiferromagnetic material:

13.9 Ferrimagnetism

13.9.1 Molecular Field Theory of ferrimagnetism

13.10 Ferromagnetic domains

13.11 Soft and hard magnetic materials

13.12 Summary

13.13 Glossary

13.14 References

13.15 Suggested readings

13.16 Terminal questions

13.1 INTRODUCTION

Magnetic materials fascinated human beings for over 4000 years. Magnetism is a phenomenon through which materials assert an attractive or repulsive force or influence on other materials. In the modern concept all materials are said to exhibit magnetism, though of different nature. When a substance is placed in a magnetic field \mathbf{H} substance gets magnetized. The magnetic moment per unit volume \mathbf{M} is produced inside the substance \mathbf{M} is called magnetization. The relation between magnetization and magnetic field is given by the equation

$$\vec{M} = \chi_m \vec{H} \quad (1)$$

The constant χ_m is called magnetic susceptibility of the material. It may be defined as the ratio of magnetization \mathbf{M} and magnetic field intensity \mathbf{H} . The value of χ_m for vacuum is zero because there is no magnetization in vacuum. In this unit we shall discuss the ferromagnetic materials and their relation with paramagnetic characteristics.

When a specimen is placed in a magnetic field \mathbf{H} it is magnetized due to alignments of current loops or spins. The magnetic flux density within the specimen is the resultant of magnetizing field and intensity of magnetization \mathbf{M} . The relation is given by

$$\vec{B} = \mu_o(\vec{H} + \vec{M}) \quad (2)$$

By susceptibility equation,

$$\text{Hence} \quad \vec{B} = \mu_o(\vec{H} + \chi_m \vec{H}) \quad (3)$$

$$\vec{B} = \mu_o(1 + \chi_m)\vec{H} \quad (4)$$

If we write

$$\mu = \mu_o(1 + \chi_m)$$

Then we have

$$\vec{B} = \mu \vec{H} \quad (5)$$

The constant μ is called magnetic permeability of the material. Magnetic permeability may be defined as the ratio of magnetic induction to the magnetic intensity. For vacuum, it is denoted by $\mu_o(4\pi \times 10^{-7} \frac{Wb}{A-m})$ and called permeability of vacuum. Hence magnetic induction in vacuum will be

$$\vec{B}_o = \mu_o \vec{H} \quad (6)$$

The ratio

$$\frac{B}{B_o} = \frac{\mu}{\mu_o} = \mu_r \quad (7)$$

is called relative permeability. This is basic idea about magnetism.

13.2 OBJECTIVES

After studying this unit, you should be able to-

- Differentiate the paramagnetic, diamagnetic, ferromagnetic, antiferromagnetic and ferrimagnetic materials.
- Understand the domain theory of ferromagnetism.
- Curies law
- Heisenberg's Exchange interaction
- Understand the domain theory of anti ferromagnetism
- Understand ferrimagnetism
- Understand the hysteresis curve and hysteresis losses.

13.3 TYPES OF MAGNETISM

According to modern theories, magnetism in solids arises due to orbital and spins motion of electrons as well as spin motion of nuclei. The motion of electrons is equivalent to an electric current which produces magnetic effect. The major contribution in magnetism comes from the spin of unpaired valence electrons which produces permanent magnetic moments. A number of such magnetic moments align themselves in different directions to generate a net non-zero magnetic moment. Therefore, the nature of magnetization produced depends on the number of unpaired valence electrons present in the atoms of the solid and on the relative orientations of the neighboring magnetic moments. As we have already studied, the magnetism in solid materials can be classified into five main groups according to their spin alignment.

1. Diamagnetism
2. Paramagnetism
3. Ferromagnetism
4. Antiferromagnetism
5. Ferrimagnetism

Diamagnetism is a very weak magnetic effect and is found in those solids which do not contain any permanent magnetic moments. Diamagnetic materials do not have unpaired electrons in them. In these materials electron spin moments are mutually cancelled and there is no interaction between individual magnetic moments (figure 13.1). These materials are weakly repelled in a magnetic field because they have a weak, negative magnetic susceptibility. Examples of diamagnetic materials are MgO, Cu, Ag, Au etc. For Paramagnetism materials, each atom possesses a permanent dipole moment by virtue of incomplete cancellation of electron spin and/or orbital magnetic moments e.g. Mg, Mo, Li etc. (figure 13.1). In the absence of an external magnetic field, the orientations of these atomic magnetic moments are random, but have small magnetic moment. A ferromagnetic material has spontaneous magnetic moment. The spontaneous magnetic moment is due to electron spin and magnetic moment arranged in regular manner. The electron spin and

magnetic moment may be arranged in different manner as shown in figure 13.1. Depending on the arrangement of orientation of spin, a magnetic material behaves as ferromagnetic, antiferromagnetic, weak ferromagnetic (canted antiferromagnetic) or ferrimagnetic. If there is an internal interaction which line up the magnetic moment parallel to each other, then the material becomes ferromagnetic. Such interaction is called exchange interaction. The orientation effect is destroyed by thermal agitations and therefore at high temperature the spin order is destroyed.

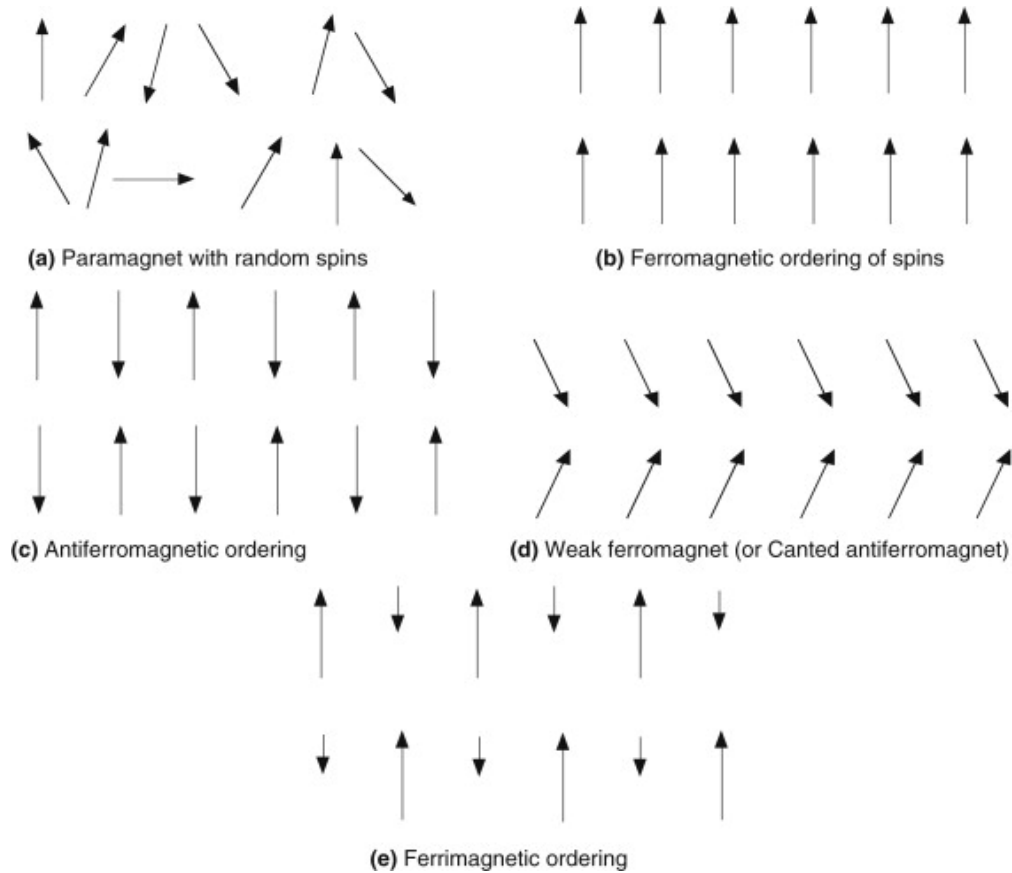

Figure 13.1: Spin orientations of different types of ferromagnetic materials

13.4 FERROMAGNETISM

Ferromagnetism is a property by which certain materials become permanent magnets. Ferromagnetism is the strongest type and is responsible for the common phenomenon of magnetism in magnets encountered in everyday life. Permanent magnets (materials that can be magnetized by an external magnetic field and remain magnetized after the external field is removed) are either ferromagnetic or ferrimagnetic. Only a few substances are ferromagnetic. The common ones are iron, cobalt, nickel (Fe, Co, Ni) and most of their alloys, and some compounds of rare earth metals. Some applications of ferromagnetism are electromagnets, electric

motors, generators, transformers, and magnetic storage such as tape recorders, and hard disks, and nondestructive testing of ferrous materials.

These materials possess a permanent magnetic moment in the absence of an external magnetic field (figure 13.2), and exhibit very large and permanent magnetizations below a certain temperature called Curie temperature (T_c). Ferromagnetic material shows maximum magnetization at 0K and start decreasing as temperature increases. Permanent magnetic moments in ferromagnetic materials result from atomic magnetic moments due to uncancelled electron spins as a consequence of the electron structure. Above a particular temperature called Curie temperature (T_c) the ferromagnetic material exhibits paramagnetism.

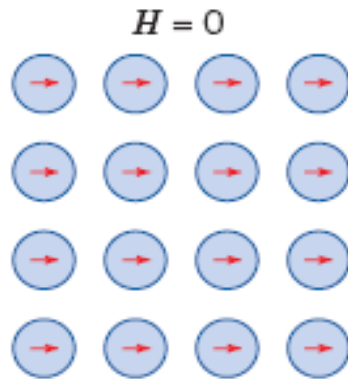

Figure 13.2: The orientation of atomic dipoles for a ferromagnetic material.

13.4.1 Weiss Molecular Field theory for Ferromagnetic Material

According to Weiss theory of ferromagnetism, a specimen of ferromagnetic material contains a number of small regions called domains which are spontaneously magnetized in a certain direction. The magnitude of spontaneous magnetization of the specimen as a whole is determined by the vector sum of the magnetic moments of individual domains. This spontaneous magnetization is responsible for internal magnetic field, and if there are atoms in specimen then they experience a magnetic field which is the sum of the internal magnetic field due to spontaneous magnetization and external magnetic field.

According to Curie-Weiss law, above the Curie temperature T_c , the susceptibility of a ferromagnetic material is given as

$$\chi_{ferro} = \frac{C}{T - T_c} \quad (8)$$

where C is the Curie- Weiss constant.

If H is external magnetic field than effective magnetic field on atom becomes

$$H_{eff} = H + H_{int} \quad (9)$$

$$H_{eff} = H + \lambda M \quad (10)$$

Since $H_{int} = \lambda M$ where λ is a parameter called Weiss-field constant, and M is magnetization. Consider a paramagnetic material with N atoms per unit volume; J is total angular momentum; g is Lande g factor, μ_B is Bohr magnrton, than magnetization can be given as

$$M = N g \mu_B J B(a) \quad (11)$$

Where $B(a)$ is Brillouin function used in magnetism and given as

$$B(a) = \frac{2J+1}{2J} \coth\left(\frac{2J+1}{2J}a\right) - \frac{1}{2J} \coth\frac{a}{2J} \quad (12)$$

Here a is the ratio of the Zeeman energy of the magnetic moment in the external field to the thermal energy $k_B T$ and a is given as

$$a = \frac{g\mu_B J}{k_B T} H_{eff} = \frac{g\mu_B J}{k_B T} (H + \lambda M) \quad (13)$$

For spontaneous magnetization $H=0$ then above eq. 13 can be given as

$$a = \frac{g\mu_B J}{k_B T} \lambda M(T) \quad (14)$$

We have replaced magnetization M by $M(T)$ as magnetization is function of temperature T . If $M_s(0)$ is saturation magnetization which is the maximum value of magnetization at absolute zero temperature than

$$M_s(0) = N g \mu_B J \quad (15)$$

Using eq. (14) and (15) the ratio of $M(T)$ and $M_s(0)$ can be given as

$$\begin{aligned} \frac{M(T)}{M_s(0)} &= \frac{a k_B T}{g\mu_B J \lambda} \cdot \frac{1}{N g \mu_B J} \\ \frac{M(T)}{M_s(0)} &= \frac{a k_B T}{N g^2 \mu_B^2 J^2 \lambda} \end{aligned} \quad (16)$$

It is clear from eq. 11 and eq. 15, if $T \rightarrow 0$ than $B(a) \rightarrow 1$. We further know from eq. (11) and eq. (15) that

$$M(T) = N g \mu_B J B(a)$$

$$M_s(0) = N g \mu_B J$$

The ratio can be given as

$$\frac{M(T)}{M_s(0)} = B(a) \quad (17)$$

On solving eq. (16) and eq. (17) simultaneously and plot a graph between a and $\frac{M(T)}{M_s(0)}$ we get a plot as shown in figure 13.3.

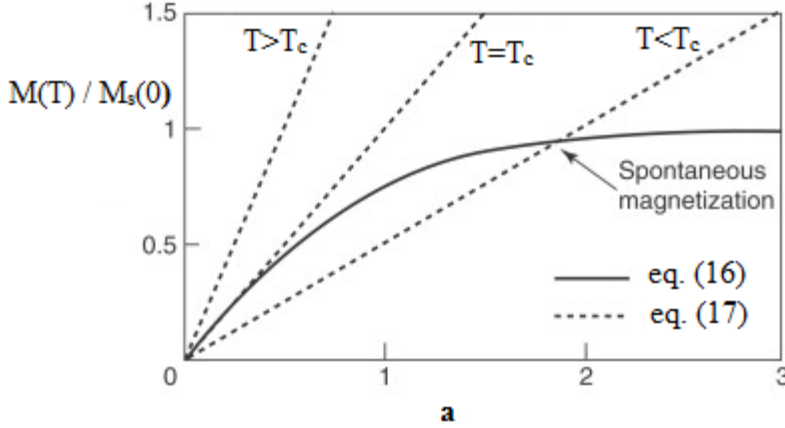

Figure 13.3: Variation of magnetization and a .

13.4.2 Relation Between T_c and λ

From equation (16) we can see that the slop of equation is given as the coefficient of a which is

$$\frac{k_B T_c}{Ng^2 \mu_B^2 J^2 \lambda} \quad (18)$$

Similarly from equation (17), we can see that the slops of equation is given by $B(a)$. If $a \ll 1$ then from eq. 12, $B(a)$ can be given as

$$B(a) = \frac{J+1}{3J} a \quad (19)$$

Thus the eq.17 becomes

$$\frac{M(T)}{M_s(0)} = \frac{J+1}{3J} a \quad (20)$$

Thus slop is again the coefficient of a and given as

$$\frac{J+1}{3J} \quad (21)$$

Equating these two slops given in eq. (18) and eq. (21)

$$\frac{J+1}{3J} = \frac{k_B T_c}{Ng^2 \mu_B^2 J^2 \lambda} \quad (22)$$

$$T_c = \frac{(J+1)Ng^2 \mu_B^2 J^2 \lambda}{3J k_B} \quad (23)$$

We know that the total magnetic moment μ can be given as

$$\mu^2 = g^2 \mu_B^2 J(J + 1) \quad (24)$$

Putting this value in eq. (23)

$$T_c = \frac{N\mu^2\lambda}{3k_B} \quad (25)$$

Thus the transition temperature is proportional to λ .

13.4.3 Temperature Dependence of Saturation Magnetization

From eq. (23)

$$\frac{k_B}{\lambda} = \frac{Ng^2\mu_B^2 J(J + 1)}{3T_c}$$

Putting this value in eq. (16)

$$\frac{M(T)}{M_s(0)} = \frac{aT}{Ng^2\mu_B^2 J^2} \frac{Ng^2\mu_B^2 J(J + 1)}{3T_c}$$

$$\frac{M(T)}{M_s(0)} = \frac{(J + 1)}{3J} \left(\frac{T}{T_c}\right) a \quad (26)$$

The plot of equation 26 can be represented by figure 13.4.

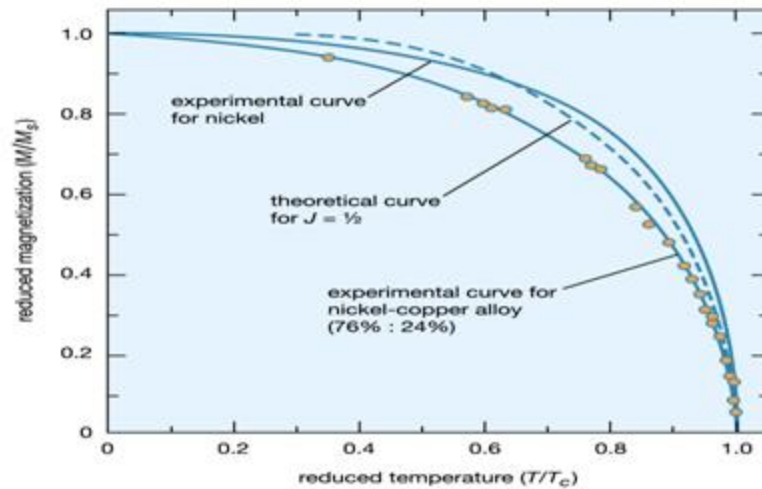

Figure 13.4: Magnetization versus temperature variation

13.4.4 Paramagnetic Region

Now we will see the behavior of ferromagnetic material above the Curie temperature. We know that above the Curie temperature the substance becomes paramagnetic.

Above T_c magnetization $M(T) = 0$ as spontaneous magnetization vanishes. For small value of a the Brillouin function can be expressed as

$$B(a) = \frac{J+1}{3J} a$$

From eq. (11) magnetization

$$\begin{aligned} M &= N g \mu_B J B(a) \\ M &= N g \mu_B J \cdot \frac{J+1}{3J} a \end{aligned} \quad (27)$$

Putting the value of a from eq.13 in eq. 27, we have

$$\begin{aligned} M &= \frac{g\mu_B J}{k_B T} (H + \lambda M) \cdot N g \mu_B J \cdot \frac{J+1}{3J} \\ M &= \frac{N g^2 \mu_B^2 J(J+1)}{3k_B T} (H + \lambda M) \end{aligned}$$

From eq. 24 the magnetic moment is given by $\mu^2 = g^2 \mu_B^2 J(J+1)$; using this expression, above expression becomes

$$\begin{aligned} M &= \frac{N\mu^2}{3k_B T} (H + \lambda M) \\ M \left(1 - \frac{N\mu^2 \lambda}{3k_B T} \right) &= \frac{N\mu^2}{3k_B T} H \end{aligned} \quad (28)$$

Magnetic susceptibility can be given as

$$\chi_m = \frac{M}{H} = \left[\frac{\frac{N\mu^2}{3k_B T}}{1 - \frac{N\mu^2 \lambda}{3k_B T}} \right] \quad (29)$$

$$\chi_m = \frac{M}{H} = \frac{C}{T - \theta} \quad (30)$$

$$\text{Where } C = \frac{N\mu^2}{3k_B} \text{ and } \theta = \frac{N\mu^2 \lambda}{3k_B} = \lambda C \quad (31)$$

The equation (29) is Curie Weiss law. This is modified Curie's law ($\chi_m = \frac{C}{T}$). The C is known as Curie constant and θ is transition temperature (T_c). The variation of magnetic susceptibility and with temperature is given in figure 13.5.

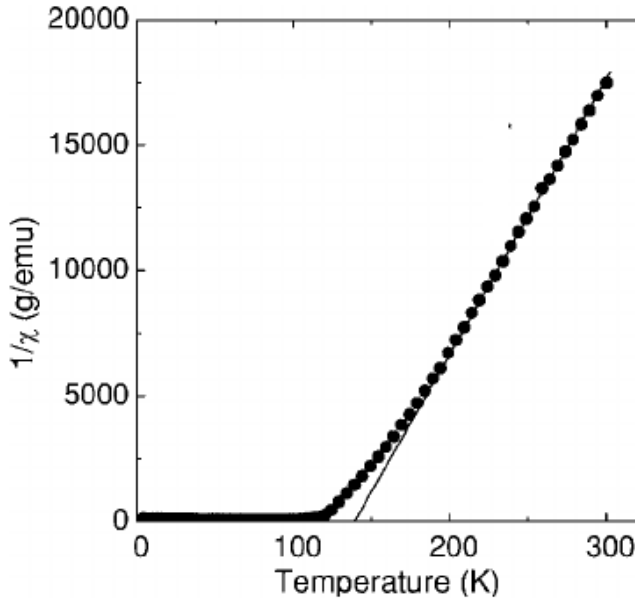

Figure 13.5: Magnetic Susceptibility versus temperature variation

13.5 HEISENBERG'S EXCHANGE INTERACTION

Magnetism arises due to spin and orbital motion of electrons or any other charge particle. Experimentally the saturation magnetization M_s is in order of 10^7 A/m. It is reasonable that such a large field cannot be due to spin orbital interaction. Heisenberg proposed that this strong magnetic interaction is must be due to exchange interaction. Ferromagnetism is due to spin interaction of electrons. The source of ferromagnetism is the spin interaction of electrons in d orbital of some elements as Fe, co, Ni. Only those elements show the ferromagnetism which have incomplete d shell. The electrons are a fermions system and possess anti symmetric wave function. A system of electron not only possesses coulomb interaction but also possesses another extra energy called exchange energy. This is purely quantum mechanical phenomenon. This interaction gives rise to collective magnetic ordering in a ferromagnetic crystal. According to Heisenberg, the interaction energy determines the strength of Weiss field. The Hamiltonian associated with exchange energy can be given as

$$H_e = -\sum_i \sum_j \frac{2}{\hbar^2} J_{ij} (S_i S_j) \quad (32)$$

Where S_i and S_j are the spin operators of ith and jth atoms respectively. J_{ij} is a parameter determining the strength of exchange force called exchange integral. If J_{ij} is positive, the material will be ferromagnetic.

The exchange energy of two electrons may be written in the given form if there is a direct coupling between two spins.

$$H_e = -2 J_{ij}(S_i \cdot S_j) \quad (33)$$

By quantum mechanical treatment we can establish a connection between exchange interaction J_{ij} and Curie temperature T_C . The quantum mechanical treatment called mean field theory and results as

$$T_c = \frac{2z}{3k} S(S + 1) J_{ij} \quad (34)$$

$$J_{ij} = \frac{3k T_c}{2 z S (S+1)} \quad (35)$$

where z is the number of nearest neighbors of atoms under consideration. Better statistical approximation gives some more complex results. For simplicity we consider this one only.

13.6 RETENTIVITY COERCIVITY AND HYSTERESIS

When a specimen of ferromagnetic material is placed in an external magnetic field the specimen is magnetized by induction. As the magnetic field intensity is varied the flux density in the material does not varies linearly which means the permeability is not constant. Permeability depends not only on the value of H but also on the past history of the material. The variation of B with the variation of H is shown in following figure 13.6. Point O represents an initially unmagnetised specimen at zero magnetic field intensity. As H is increased B also increased but not uniformly, and a point such as 'a' is reached where B becomes constant, and substance is called magnetically saturated. Magnetization corresponding to this point is called saturation magnetization M_s .

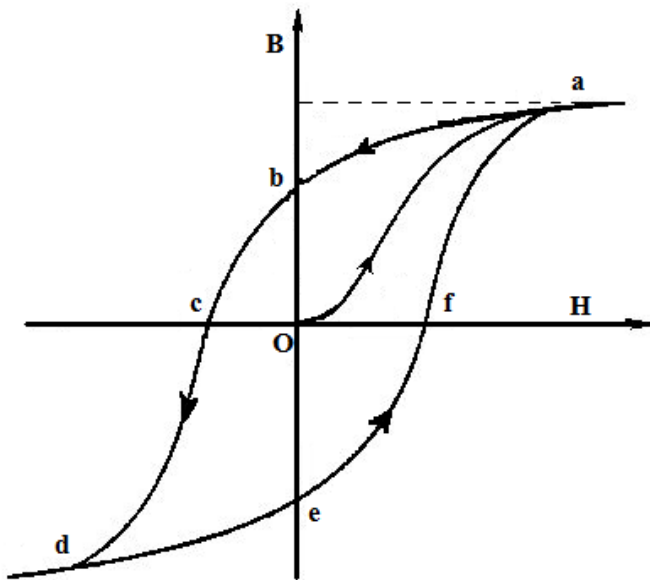

Figure 13.6: Hysteresis loop of a ferromagnetic material.

If H is now decreased, B also decreases but following a different path abc , thus B lags behind H . when H becomes zero B still has a value Ob . This magnetic flux density remaining in the specimen

in the absence of any external field is called residual magnetism. The property of bearing this magnetism is called retentivity or remanence of the material. If the magnetic field intensity \mathbf{H} is increased in reversed direction, the value of \mathbf{B} further decreased, still lagging behind \mathbf{H} , and becomes zero when magnetic field intensity \mathbf{H} has a value equal to Oc . This value of magnetic intensity is called the coercivity of the specimen. Thus, coercivity is a measure of the magnetic intensity required to destroy the residual magnetism of a specimen.

When \mathbf{H} is increased beyond Oc the specimen is strongly magnetized in opposite direction and a point such as d is reached after which magnetization becomes constant. Magnetization corresponding to this point is also called saturation magnetization \mathbf{M}_s . reducing \mathbf{H} from this point d to zero and again increasing in another direction a similar curve $defa$ is obtained at point b and e where substance consist magnetization in the absence of external magnetic field, is said to be permanent magnet. The closed curve $abcdefa$ is known as hysteresis curve of the substance. Hysteresis curve shows that \mathbf{B} always lags behind \mathbf{H} when \mathbf{H} changes.

13.7 SPIN WAVE AND MAGNONS

The magnetism is a property arises due to the spin of electrons in the atoms. There is interaction among the spins which is responsible for magnetic properties. We consider only nearest neighbor interaction for simplicity. A spin wave is a propagating disturbance in the spin ordering of a magnetic material. Let us consider a ferromagnetic material, with one dimensional chain of atoms with parallel spins. If there are n spins, then there will be $N-1$ pairs of spins as shown in figure 13.7(a). At zero temperature the all spins are at ground state and aligned in parallel direction. If temperature increases, the thermal energy will available for excitation, and this excitation flip the one spin. In the first excitation state only one spin is flipped shown in figure 13.7b.



Figure 13.7(a): Ground state and excited state of spins

Since the excitation spin cannot be isolated from the neighbor, therefore quantum mechanically, the excited single spin is spread over the system. Thus the single flip (excitation) of spin is equivalent to propagation of flipping of spins as in figure 13.7(b). In this figure there are different cones for representing spin and the spin initially all parallel, starts rotating step by step. If we look at the top of cones, as shown in second figure, the locus of points of arrow forms a wave. The propagation of such flipping of spins form a wave which is spin wave.

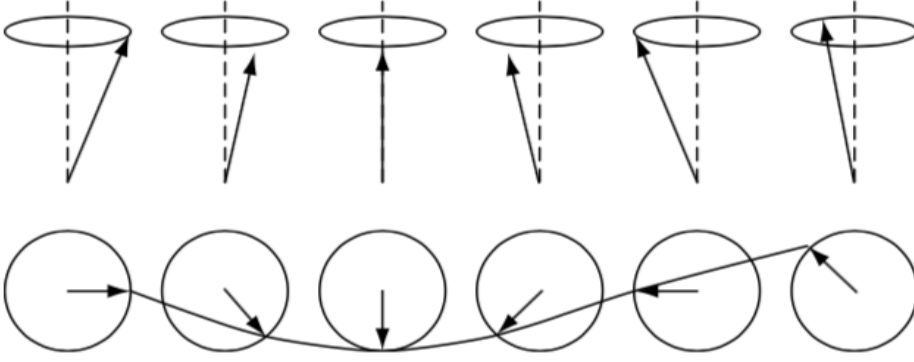

Figure 13.7(b): Propagation of flipping of spin or spin wave

According to Heisenberg exchange interaction model, the exchange energy in ground state is given by

$$E_{ex} = -2JS_i S_j (N - 1) = -2JS^2 (N - 1) \quad (36)$$

In excited state when one spin is flipped than energy increase and given as

$$\begin{aligned} E_{ex} &= -2JS^2 (N - 3) + 2(2JS^2) \\ E_{ex} &= -2JS^2 (N - 1) - 2J(-2)JS^2 + 4JS^2 \\ E_{ex} &= -2JS^2 (N - 1) + 8JS^2 \end{aligned} \quad (37)$$

Thus the energy of excited state increased by $8JS^2$ arises due to flip of one spin. This flip is spread over the system as shown in figure. As light and phonon wave is quantize similarly the spin wave is also quantize and the quanta of energy associated with spin wave is known as megnon. Now we will find out the dispersion relation for spin wave.

The Heisenberg exchange energy for nearest spins is given as

$$U = -2J \sum_p^N S_p S_{p+1} \quad (38)$$

Where N is number of spins in ground state, S_p is spin of 1st atom, J is exchange integral, $\hbar S_p$ is spin angular momentum. If we consider S_p as classical vector then for ground state then the product of spin angular moment can be simplify as $S_p \cdot S_{p+1} = S^2$ and exchange energy becomes $U_0 = -2N J S^2$.

For the interaction of pth spin with (p-1) and (p+1)th spins can be given as

$$U = -2J S_p \cdot (S_{p-1} + S_{p+1}) \quad (39)$$

The magnetic moment at p^{th} atom is given as

$$\mu_p = -g \mu_B S_p \quad (40)$$

thus the eq.17 can be given

$$U = -2J (-\mu_p/g \mu_B) \cdot (S_{p-1} + S_{p+1})$$

$$U = -\boldsymbol{\mu}_p \cdot (-2J/g \mu_B)(S_{p-1} + S_{p+1}) \quad (41)$$

This expression of the form of $U = \boldsymbol{\mu}_p \cdot B_p$ which nothing but the energy stored by a dipole in an effective magnetic field B can be considered as exchange energy U. From eq. 18 the effective magnetic field B can be given as

$$B_p = (-2J/g \mu_B)(S_{p-1} + S_{p+1}) \quad (42)$$

We know that the rate of change of angular momentum is equal to the torque thus

$$\frac{d}{dt}(\hbar S_p) = \mu_p \times B_p \quad (43)$$

Putting the values form eq. 18 and eq. 20

$$\frac{dS_p}{dt} = (-g \mu_B/\hbar) S_p \times B_p = (-g \mu_B/\hbar) S_p \times (-2J/g \mu_B)(S_{p-1} + S_{p+1})$$

$$\frac{dS_p}{dt} = (2J/\hbar) (S_p \times S_{p-1} + S_p \times S_{p+1}) \quad (44)$$

In Cartesian coordinate system x component of equation (44) can be written as

$$\frac{dS_p^x}{dt} = (2J/\hbar)[S_p^y(S_{p-1}^z \times S_{p+1}^z) - S_p^z(S_{p-1}^y \times S_{p+1}^y)] \quad (45)$$

Similarly, we can find the y and z components of this equation 45.

For simplicity if we consider the amplitude of excitations is small and we can consider $S_p^z = S$ and $S_p^x, S_p^y \ll S$ than eq.45 can be written as

$$\frac{dS_p^x}{dt} = (2J/\hbar)[2S_p^y - S_{p-1}^y - S_{p+1}^y] \quad (46a)$$

$$\frac{dS_p^y}{dt} = (2J/\hbar)x[2S_p^x - S_{p-1}^x - S_{p+1}^x] \quad (46b)$$

$$\frac{dS_p^z}{dt} = 0 \quad (46c)$$

These are the differential equations and by analogy to phonon dispersion relation the standard solution of such equation can be considered as

$$S_p^x = u \exp[i(pka - \omega t)] \quad (47a)$$

$$S_p^y = v \exp[i(pka - \omega t)] \quad (47b)$$

Where u and v are constants k is wave vectors, a is lattice constant and p is any integer number. Putting the value of S from equation (47) to equation (46) we get

$$-i\omega u = (2JS/\hbar)[2 - e^{ika} - e^{-ika}]v = (4JS/\hbar)(1 - \cos ka)v$$

$$-i\omega v = (2JS/\hbar)[2 - e^{ika} - e^{-ika}]u = (4JS/\hbar)(1 - \cos ka)u$$

To solve above equation, we can arrange the coefficient in determinant as

$$\begin{vmatrix} i\omega & (4JS/\hbar)(1 - \cos ka) \\ (4JS/\hbar)(1 - \cos ka) & i\omega \end{vmatrix} = 0$$

$$\hbar\omega = (4JS)(1 - \cos ka) \quad (48)$$

This is the dispersion relation of spin wave in one dimensional case. For long wavelengths if we consider $ka \ll 1$ than $1 - \cos ka \approx \frac{1}{2} k^2 a^2$ and eq. (48) can be given as

$$\hbar\omega = 2JS a^2 k^2 \quad (49)$$

For a typical ferromagnetic material, the magnon dispersion relation as given in eq. 48 is shown in figure 13.8a. The spin wave also quantized exactly as phonon wave.

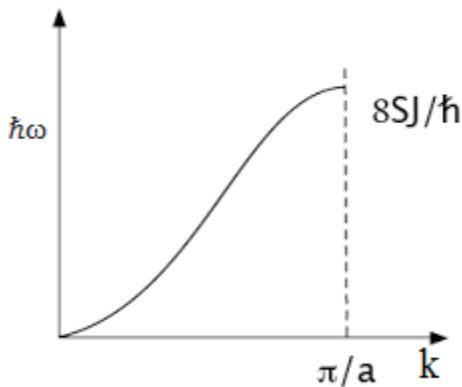

Figure 13.8a: Magnon dispersion relation for a ferromagnetic material.

13.7.1 Quantization of Spin Wave

The energy of a mode of frequency ω_k associated with spin wave is given as

$$\epsilon_k = (n + 1/2)\hbar\omega_k \quad (50)$$

where n is integer number. The quantum of energy is known as megnon.

13.8 ANTIFERROMAGNETISM

In one this case, the coupling among the neighboring atoms or lattice points are in antiparallel ordering; the alignment of the spin moments of neighboring atoms or ions are in exactly opposite directions, such magnetic materials are termed as antiferromagnetism. Manganese oxide (MnO) is one material that displays this behavior (figure 13.8b). Antiferromagnetism occurs below a critical temperature called Neel temperature T_N . Above T_N , antiferromagnetic material becomes paramagnetic.

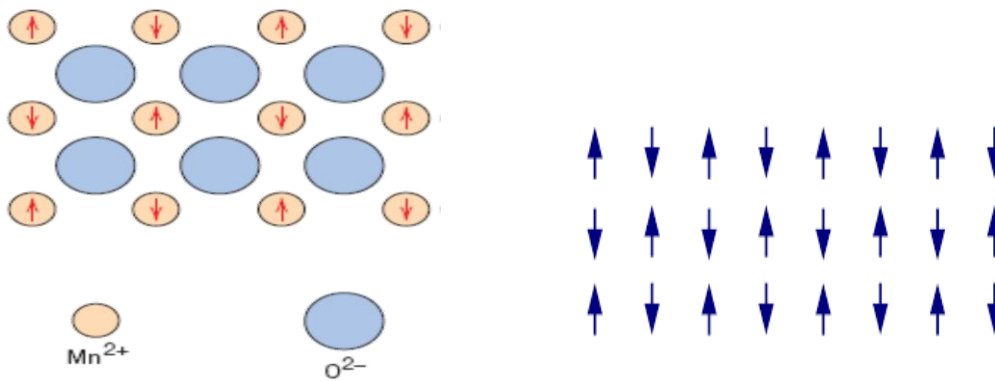

Figure 13.8b: Antiparallel alignment of spin magnetic moments for antiferromagnetic manganese oxide.

Due to antiparallel spins ordering, the net magnetic moment of material is zero. As temperature increases, the anti-parallel arrangement disturbed and magnetization increases up to a certain temperature called Neel's Temperature (T_N), after this temperature the antiferromagnetic material behaves as paramagnetic as shown in figure 13.8c.

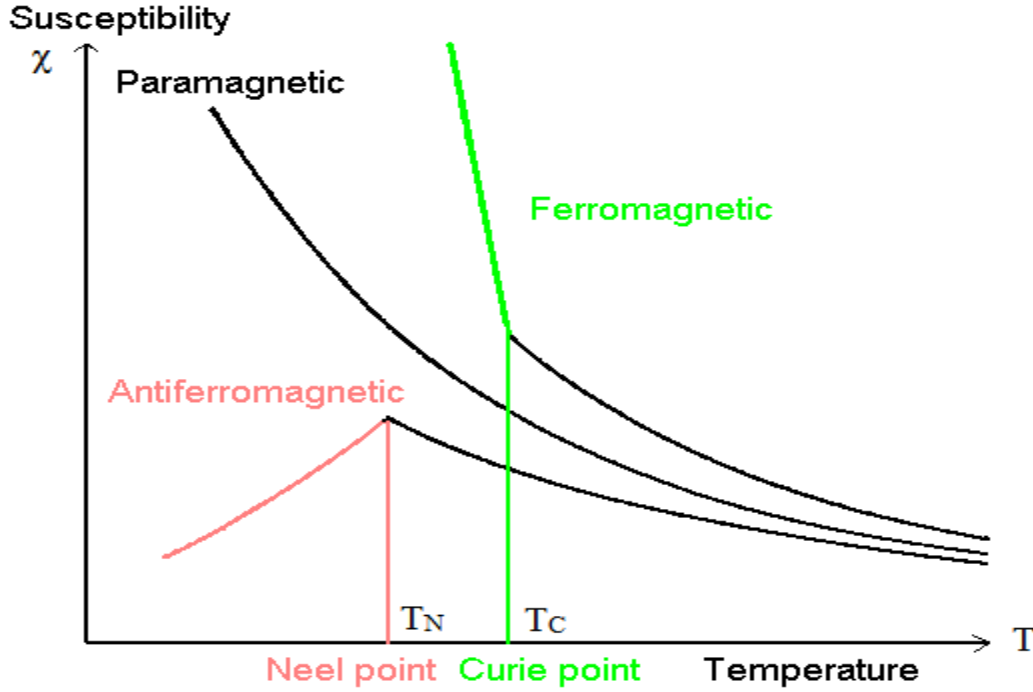

Figure 13.8c: magnetic susceptibility of antiferromagnetic material and Neel's Temperature.

13.8.1 Molecular Field Theory of Antiferromagnetic Material

Consider an antiferromagnetic material which has two type sub-lattices AB. The example of such sub lattice system is Manganese oxide (MnO) as shown in figure 13.8c. In such antiferromagnetic material, there are three types of interactions as AA, BB and AB.

The molecular field at atom A can be given as

$$H_{ma} = H - \alpha M_a - \beta M_b \quad (51a)$$

Similarly, molecular field at atom B can be given as

$$H_{mb} = H - \beta M_a - \alpha M_b \quad (51b)$$

Where α and β are Weiss constants. α is for AA and BB type interaction between AA and BB type atoms, and β is interaction between AB type atoms. H is external magnetic field, and M_a magnetization of atom A and M_b magnetization of atom B. Now there are two cases.

Case1: If $T > T_N$ (Temperature is greater than Neel's Temp.) paramagnetic region:

Magnetization of atom A:

$$M_a = \frac{N\mu^2}{3k_B T} H_{ma} \quad (52)$$

Where μ is total magnetic moment and given as $\mu^2 = g^2 \mu_B^2 J(J + 1)$

Similarly, the Magnetization of atom B:

$$M_b = \frac{N\mu^2}{3k_B T} H_{mb} \quad (53)$$

Total magnetization can be given as

Magnetization of atom A:

$$M = M_a + M_b = \frac{N\mu^2}{3k_B T} (H_{ma} + H_{mb}) \quad (54)$$

Putting the value from eq. (51)

$$M = \frac{N\mu^2}{3k_B T} (H - \alpha M_a - \beta M_b + H - \beta M_a - \alpha M_b)$$

$$M = \frac{N\mu^2}{3k_B T} (2H - \alpha(M_a + M_b) - \beta(M_a + M_b))$$

Putting the value of M_a, M_b from eq. (54)

$$M = \frac{N\mu^2}{3k_B T} (2H - \alpha M - \beta M)$$

$$M = \frac{N\mu^2}{3k_B T} (2H - M(\alpha + \beta))$$

$$M \left(\frac{3k_B T}{N\mu^2} \right) = 2H - M(\alpha + \beta)$$

$$M \left(\frac{3k_B T}{N\mu^2} + (\alpha + \beta) \right) = 2H$$

$$\frac{M}{H} = \frac{2N\mu^2}{3k_B T + (\alpha + \beta)N\mu^2}$$

$$\frac{M}{H} = \frac{2N\mu^2/3k_B T}{1 + (\alpha + \beta)N\mu^2/3k_B T}$$

$$\frac{M}{H} = \frac{2N\mu^2/3k_B T}{1 + (\alpha + \beta)N\mu^2/3k_B T} \quad (55)$$

$$\chi_m = \frac{M}{H} = \frac{C/T}{1 + \frac{C}{2T}(\alpha + \beta)} \quad (56)$$

Where $C = 2N\mu^2/3k_B$ is Curie constant and if $\frac{C}{2}(\alpha + \beta) = \theta$ then eq. (56) can be given as

$$\chi_m = \frac{M}{H} = \frac{C}{T + \theta} \quad (57)$$

This is the magnetic susceptibility for antiferromagnetic material. Now as we already calculated the magnetic susceptibility of paramagnetic and ferromagnetic material (eq.30) thus the inverse of magnetic susceptibilities all these materials can be given as follow and shown in figure 13.9.

$$\frac{1}{\chi_{para}} = \frac{T}{C} \quad , \quad \frac{1}{\chi_{ferro}} = \frac{T - \theta}{C} \quad , \quad \frac{1}{\chi_{antiferro}} = \frac{T + \theta}{C} \quad (58)$$

This can be noted here the curie constant for ferromagnetic material is $C = N\mu^2/3k_B$ and curie constant for antiferromagnetic material is $C = 2N\mu^2/3k_B$. Thus curie constant for antiferromagnetic material is double to ferromagnetic material. According to eq. (58). The inverse of magnetic susceptibility can be shown in figure 13.9.

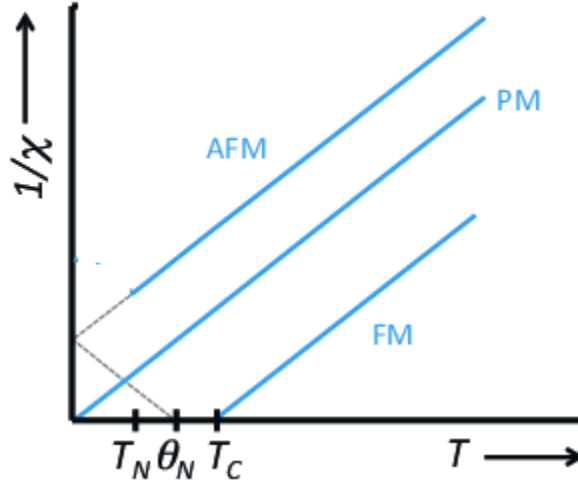

Figure 13.9: Magnetic susceptibility for paramagnetic, ferromagnetic and antiferromagnetic materials

Case 2: If $T < T_N$ (Temperature is less than Neel's Temp.):

This is antiferromagnetic region. In this case, if there is no external field than according to eq. (52), the magnetization of atom A can be given as

$$M_a = \frac{N\mu^2}{3k_B T} H_{ma} \quad (59)$$

In the absence of external magnetic field, the molecular field at atom A can be given as

$$H_{ma} = -\alpha M_a - \beta M_b \quad (60)$$

Putting the value in eq. (59) we get

$$M_a = \frac{N\mu^2}{3k_B T} [-\alpha M_a - \beta M_b] \quad (61)$$

$$M_a + \frac{N\mu^2}{3k_B T} \alpha M_a = -\frac{N\mu^2}{3k_B T} \beta M_b$$

$$M_a \left[1 + \frac{N\mu^2}{3k_B T} \alpha \right] = -\frac{N\mu^2}{3k_B T} \beta M_b \quad (62)$$

Similarly, for molecular B can be given as

$$M_b \left[1 + \frac{N\mu^2}{3k_B T} \alpha \right] = -\frac{N\mu^2}{3k_B T} \beta M_a \quad (63)$$

The eq. (62) and eq. (63) can be solve by determinant method and comparing the coefficients of M_a and M_b

$$\begin{vmatrix} 1 + \frac{N\mu^2}{3k_B T} & \frac{N\mu^2}{3k_B T} \beta \\ \frac{N\mu^2}{3k_B T} & 1 + \frac{N\mu^2}{3k_B T} \end{vmatrix} = 0$$

$$\left[1 + \frac{N\mu^2}{3k_B T} \alpha \right]^2 - \left(\frac{N\mu^2}{3k_B T} \beta \right)^2 = 0$$

$$\left[1 + \frac{N\mu^2}{3k_B T} \alpha \right] = \left(\frac{N\mu^2}{3k_B T} \beta \right)$$

$$\frac{N\mu^2}{3k_B T} (\beta - \alpha) = 1 \quad (64)$$

If $\frac{N\mu^2}{3k_B T} = \frac{C}{2}$ where C is curie constant and T is now Neel's temperature T_N , then

$$\frac{C}{2 T_N} (\beta - \alpha) = 1$$

$$T_N = \frac{C}{2} (\beta - \alpha) \quad (65)$$

And if $\theta = \frac{C}{2} (\beta + \alpha)$, another parameter than

$$\frac{T_N}{\theta} = \frac{\beta - \alpha}{\beta + \alpha} \quad (66)$$

Thus the Neel's temperature depends on Weiss constants α and β . When α increases Neel's temperature decreases. On the other hand if β increases Neel's temperature also increases.

13.9 FERRIMAGNETISM

If the neighboring atoms of antiferromagnetic material have spins anti-parallel but the magnitude are unequal than the material is define ferrimagnetic. Thus the solid material exhibits net spontaneous magnetic moment. Figure 13.1 shows the spin orientations of ferrimagnetic materials. The ferromagnetic materials have great industrial applications and these materials are known as ferrites. These materials may be represented by the chemical formula MFe_2O_4 in which M represents any one of several metallic elements (Mn, Fe, Co, Ni, Cu, Zn etc.). The prototype ferrite is Fe_3O_4 , the mineral magnetite, sometimes called lodestone. The formula for Fe_3O_4 may be written as $(Fe^{+2})(Fe^{+3})_2O_4$ in which the Fe ions exist in both +2 and +3 valence states in the ratio of 1:2. A net spin magnetic moment exists for each Fe^{+2} and Fe^{+3} ions, which corresponds to 4 and 5 Bohr magnetons, respectively. There are antiparallel spin-coupling between the Fe ions, similar in character to antiferromagnetism. However, the net moment arises from the incomplete cancellation of spin moments. Figure 13.10 shows the opposing magnetic moments of two different sites. As a result, the solid as a whole possesses some net magnetic moment.

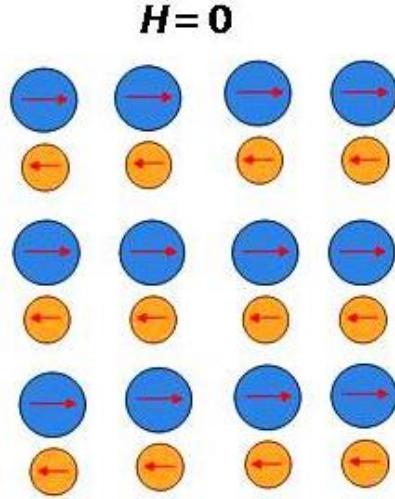

Figure 13.10: Antiparallel alignment of spin magnetic moments for ferrimagnetic materials.

13.9.1 Molecular Field Theory of Ferrimagnetism

As we discussed earlier, we consider a ferrimagnetic material which has two type sub-lattices AB. The example of such sub lattice system is shown in figure 13.10. In such antiferromagnetic material, there are three types of interactions as AA, BB and AB. The only difference is that all spin interactions have negative exchange energy.

The mean magnetic field experiences by atom A can be given as

$$B_a = -\lambda M_a - \mu M_b \quad (67a)$$

Similarly, molecular field at atom A can be given as

$$B_b = -\mu M_a - \nu M_b \quad (67b)$$

The negative sign is due to anti parallel spin arrangement. Here λ, μ, ν are positive Weiss constant for ferromagnetic materials. The interaction energy can be given as

$$U = \frac{1}{2}(B_a M_a - B_b M_b) \quad (68)$$

Putting values of B_a, B_b from eq. 67 we get

$$U = \frac{1}{2}\lambda M_a^2 + \mu M_a M_b + \frac{1}{2}\nu M_b^2 \quad (69)$$

Suppose we consider AA and BB interactions are very weak and only ASB interaction is strong than eq.67 can be given as

$$B_a = -\mu M_b \quad (67a)$$

Similarly, molecular field at atom A can be given as

$$B_b = -\mu M_a \quad (67b)$$

If C_a is the curie constant for atom A, and C_b is curie constant for atom B than mean field approximation

$$M_a T = C_a (B - \mu M_b) \quad (68a)$$

$$M_b T = C_b (B - \mu M_a) \quad (68b)$$

In absence of external magnetic field $B=0$, if we solve eq. 68 by determinant method

$$T = \mu \sqrt{C_a C_b} \quad (69)$$

Using eq. 68 and 69 we can calculate the magnetic susceptibility as

$$\chi_m = \frac{M}{H} = \frac{T(C_a + C_b) - 2\mu C_a C_b}{T^2 - T_c^2} \quad (70)$$

This is the expression for magnetic susceptibility of ferrimagnetic material or ferrites. Figure 13.11 show the variation of magnetic susceptibility with temperature.

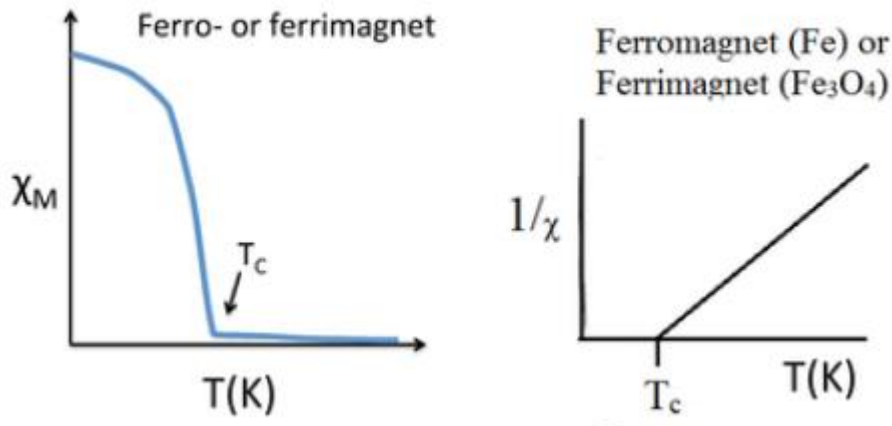

Figure 13.11: Magnetic susceptibility of Ferromagnetic or ferrimagnetic material

13.10 FERROMAGNETISM DOMAINS

Ferromagnetic domains are small regions in ferromagnetic materials within which all the magnetic dipoles are aligned parallel to each other. When cooled below a temperature called the Curie temperature, the magnetization of a piece of ferromagnetic material spontaneously divides into many small regions called magnetic domains. When a ferromagnetic material is in its demagnetized state, the magnetization vectors in different domains have different orientations, and the total magnetization averages to zero. The process of magnetization causes all the domains to orient in the same direction. Magnetic domain structure is responsible for the magnetic behavior of ferromagnetic materials like iron, nickel, cobalt and their alloys, and ferrimagnetic materials like ferrite. This includes the formation of permanent magnets and the attraction of ferromagnetic materials to a magnetic field. The regions separating magnetic domains are called domain walls, where the magnetization rotates coherently from the direction in one domain to that in the next domain. The study of magnetic domains is called micromagnetics. Paramagnetic and diamagnetic materials, in which the dipoles align in response to an external field but do not spontaneously align, do not have magnetic domains.

The reason a piece of magnetic material such as iron spontaneously divides into separate domains, rather than exist in a state with magnetization in the same direction throughout the material, is to minimize its internal energy. A large region of ferromagnetic material with a constant magnetization throughout will create a large magnetic field extending into the space outside itself as shown in figure 13.12. This requires a lot of magnetostatic energy stored in the field. To reduce this energy, the sample can split into two domains or four domains, with the magnetization in opposite directions in each domain. The magnetic field lines pass in loops in opposite directions

through each domain, reducing the field outside the material. To reduce the field energy further, each of these domains can split also, resulting in smaller parallel domains with magnetization in alternating directions, with smaller amounts of field outside the material. Figure 13.13 shows the Ferromagnetic materials divided into several domains, with the random magnetization

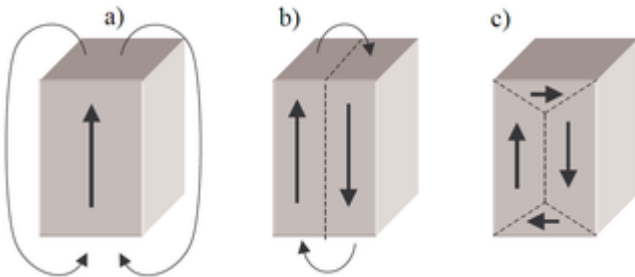

Figure 13.12: splitting of ferromagnetic materials into two and four domains, with the magnetization in opposite directions in each domain to minimize the energy

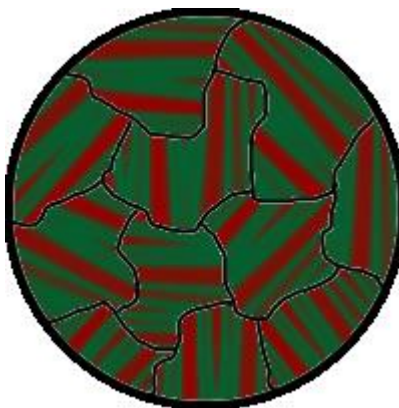

Figure 13.13: Ferromagnetic materials divided into several domains, with the random magnetization

13.11 SOFT AND HARD MAGNETIC MATERIALS

The wide variety of magnetic materials can be sharply divided into two groups, the magnetically soft (easy to magnetize and demagnetize) and the magnetically hard (hard to magnetize and demagnetize). The distinguishing characteristic of the first category is high permeability. Magnetically hard materials, on the other hand, are made into permanent magnets; here a high coercivity is a primary requirement because a permanent magnet once magnetize must be able to resist the demagnetizing action. Most widely used permeable materials are iron and iron alloys. Almost pure iron is used as the magnetic core for direct current applications. The maximum permeability is obtained for a composition of about 79% nickel and the balance is iron. Such an alloy shows zero magnetostriction and zero anisotropy and that is why the permeability is high.

The addition of molybdenum or chromium increases as the electrical resistivity thereby reducing the eddy current losses.

The most widely used permanent magnetic materials are low alloy steels containing 0.6 to 1% carbon which are hardened by quenching. The permanent magnetic materials usually hard, brittle and difficult to shape so that they must be cast and finished by grinding. For many applications a permanent magnet is the better choice, because it provides a constant field without the continuous expenditure of electric power and without the generation of heat. A magnet can be regarded as an energy storage device. This energy is put into it when it is first magnetized and it remains in the magnet. In short the magnetism is permanent. Moreover, the energy of a magnet, which is chiefly the energy of its external field, is always available for use and is not drained away by repeated use, like the energy of a battery, because a magnet does no network on its surroundings.

Example 1: A magnetic field of 20 CGS units produces a flux of 2400 CGS units in a bar of iron of cross section 0.2cm^2 . Calculate the permeability, intensity of magnetization and susceptibility of a bar.

Solution: the flux density in a bar is

$$B = \frac{\Phi}{A} = \frac{2400}{0.2} = 12000 \text{ gauss}$$

Therefore, the permeability of the bar is

$$\mu = \frac{B}{H} = \frac{12000}{20} = 600 \text{ CGS units}$$

The intensity of magnetization is

$$I = \frac{B - H}{4\pi} = \frac{12000 - 20}{4 \times 3.14} = 953.8$$

The relation between permeability μ and susceptibility χ_m is

$$\chi_m = \frac{\mu - 1}{4\pi} = \frac{600 - 1}{4 \times 3.14} = 47.7 \text{ CGS units}$$

Example 2: the hysteresis loop for a specimen of 12 kg is equivalent to 3000 ergs/cm^3 . Find the loss of energy per hour at a frequency of 50 cycle/ sec, if density of iron is 7.5 gm/cm^3 .

Solution: the energy dissipated per cm^3 per hysteresis loop is given to be 3000 ergs. The volume of the core is mass/ density.

$$\frac{12000}{7.5} = 1600 \text{ cm}^3$$

Therefore, the energy dissipated in the specimen per cycle

$$= 1600 \times 3000 = 4.8 \times 10^6 \text{ ergs}$$

The number of cycles in one hour is

$$= 50 \times 60 \times 60 = 1.8 \times 10^5$$

$$\text{energy loss per hour} = 1.8 \times 10^5 \times 4.8 \times 10^6$$

$$= 8.64 \times 10^{11} \text{ ergs}$$

13.12 SUMMARY

1. The relation between magnetization \vec{M} and magnetic field H and magnetic susceptibility χ_m is given by the equation

$$\vec{M} = \chi_m \vec{H}$$

2. The magnetic flux density B within the specimen is given by

$$\vec{B} = \mu_o(\vec{H} + \vec{M})$$

$$\text{and } \mu = \mu_o(1 + \chi_m)$$

$$\vec{B} = \mu \vec{H} \quad ; \text{ constant } \mu \text{ is called magnetic permeability.}$$

3. Ferromagnetism is a property by which certain materials become permanent magnets. These metallic materials possess a permanent magnetic moment in the absence of an external magnetic field and exhibit very large and permanent magnetizations below a certain temperature called Curie temperature (T_c).

4. According to Curie-Weiss law, Above the Curie temperature T_c , the susceptibility of a ferromagnetic material is given as

$$\chi_m = \frac{M}{H} = \frac{C}{T - T_c}$$

$$\text{Where Curie constant } C = \frac{N\mu^2}{3k_B} \text{ and } T_c = \theta = \frac{N\mu^2\lambda}{3k_B} = \lambda C$$

$$\text{And Curie temperature } T_c = \frac{(J+1)Ng^2\mu_B^2 J^2\lambda}{3J k_B}$$

5. According to Heisenberg exchange interaction, the interaction energy determines the strength of Weiss field. The Hamiltonian associated with exchange energy can be given as $H_e = -\sum_i \sum_j \frac{2}{\hbar^2} J_{ij}(S_i S_j)$

Where S_i and S_j are the spin operators of i th and j th atoms respectively. J_{ij} is a parameter determining the strength of exchange force called exchange integral. If J_{ij} is positive, the material will be ferromagnetic.

6. A spin wave is a propagating disturbance in the spin ordering of a magnetic material.

According to Heisenberg exchange interaction model, the exchange energy in ground state is given by

$$E_{ex} = -2JS_i S_j(N - 1) = -2JS^2(N - 1)$$

In excited state when one spin is flipped than energy increase and given as

$$E_{ex} = -2JS^2(N - 1) + 8JS^2$$

Thus the energy of excited state increased by $8JS^2$ arises due to flip of one spin.

7. The dispersion relation of spin wave in one dimensional case can be given as

$$\hbar\omega = 2JS a^2 k^2$$

8. The energy of a mode of frequency ω_k associated with spin wave is given as

$$\epsilon_k = (n + 1/2)\hbar\omega_k$$

where n is integer number. Thus the spin wave also quantized. The quantum of energy is known as megnon.

9. Antiferromagnetism occurs below a critical temperature called Neel temperature T_N . Above T_N , antiferromagnetic material becomes paramagnetic. According to molecular field theory

$$\frac{M}{H} = \frac{2N\mu^2/3k_B T}{1 + (\alpha + \beta)N\mu^2/3k_B T}$$

$$\chi_m = \frac{M}{H} = \frac{C/T}{1 + \frac{C}{2T}(\alpha + \beta)}$$

Where $C = 2N\mu^2/3k_B$ is Curie constant and if $\frac{C}{2}(\alpha + \beta) = \theta$ then eq. (56) can be given as

$$\chi_m = \frac{M}{H} = \frac{C}{T + \theta}$$

10. Susceptibilities can be listed as

$$\frac{1}{\chi_{para}} = \frac{T}{C} \quad , \quad \frac{1}{\chi_{ferro}} = \frac{T - \theta}{C} \quad , \quad \frac{1}{\chi_{antiferro}} = \frac{T + \theta}{C} \quad (58)$$

11. If the neighboring atoms of antiferromagnetic material have spins anti-parallel but the magnitude are unequal than the material is define ferrimagnetic. Thus the solid material exhibits net spontaneous magnetic moment.

12. According to Molecular Field Theory of ferrimagnetism

$$T = \mu \sqrt{C_a C_b}$$

$$\chi_m = \frac{M}{H} = \frac{T(C_a + C_b) - 2\mu C_a C_b}{T^2 - T_c^2}$$

13. Ferromagnetic domains are small regions in ferromagnetic materials within which all the magnetic dipoles are aligned parallel to each other.

13.13 GLOSSARY

Specimen – sample

Flux density – Flux passing through per unit volume

Domain – small regions

Orientation - direction

Susceptibility – sensitivity

Retentivity – tendency to retain

Saturation magnetization – limit to be magnetized

Remanence – residual magnetism

Hysteresis – tendency to remember their magnetic history.

13.14 REFERENCES

1. Charles Kittel, Introduction to Solid State Physics, Wiley Eastern Limited 1976
2. H. C. Gupta, Solid State Physics, Vikas Publishing House Private Limited 1995
3. A. J. Dekkar, Solid State Physics, The Macmillan Press Ltd. 1981
4. <https://en.wikipedia.org/wiki/Magnetism>
5. Dr. Jashangeet Kaur, online lectures,
<https://www.youtube.com/channel/UCs2wMhTEMuU94m6j6RJEWDA/videos>

13.15 SUGGESTED READINGS

1. J. Callaway, Quantum Theory of the Solid State, Part A & B, Academic Press, New York (1974)
2. R. Kubo and T. Nagamiya, Solid State Physics, McGraw-Hill, New York (1969). 1992
3. Uichiro Mizutani, Introduction to the Electron Theory of Metals, Cambridge University Press, 2014.
4. S.O. Pillai. Solid State Physics, New age international Publishers.

13.16 TERMINAL QUESTIONS

13.16.1 Short Answer Type Questions

1. What do you mean by magnetic susceptibility and magnetisation?
2. Explain Ferromagnetism.
3. What is Heisenberg exchange interaction?
4. What is hysteresis? Discuss a brief laboratory method for determining the hysteresis curve of a sample of iron. What is the utility of the curve? Derive an expression for the energy dissipated in hysteresis cycle.
5. Write short notes on (i) Hysteresis, (ii) magnetic circuit and (iii) Magnetic reluctance.

6. A paramagnetic substance of volume 40 cm^3 is placed in a magnetic field of intensity 500 oersted. Find (i) the magnetization, (ii) permeability and (iii) mass susceptibility. Given that susceptibility = 0.3×10^{-3} and density = $5.0 \frac{\text{g}}{\text{cm}^3}$.

[Ans. (i) 150 joule/ weber- m^3 , (ii) 1.0038, (iii) $6 \times 10^{-8} \text{ kg} - \text{m}^3$]

7. Two rectangular blocks of length 20 cm and 10 cm, each of area $3\text{cm} \times 5\text{cm}$ are connected in series. Assuming magnetic induction uniform throughout the blocks, find the net reluctance and permeance. The relative permeabilities of blocks are 500 and 2000 respectively.

[Ans. $1.59 \times 10^5 \text{ h}^{-1}$, $6.3 \times 10^{-6} \text{ h}$]

8. Consider a typical magnetic field of 10^4 gauss and compare the magnetic potential energy of an electron spin dipole moment with kT at room temperature. [Ans. $\frac{\mu H}{kT} \approx 2.3 \times 10^{-3}$]

9. A magnetic material has magnetization of 3300 ampere/meter and flux density of 0.0044 Wb/m^2 . Calculate the magnetizing field and the relative permeability of the material.

[Ans. 203A/m, 17.3]

10. The magnetic field intensity in a piece of ferric oxide is 10^6 ampere/ meter. If the susceptibility of the material at room temperature is 1.5×10^{-3} , compute the flux density and magnetization of the material. [Ans. 1.259 Wb/m^2 , 1500 A/m]

13.16.2 Long Answer Type Questions

1. Show that the magnetization in a field B for a paramagnetic material is given by
2. Give the Weiss theory of ferromagnetism and find out the magnetic susceptibility of ferromagnetic material.
3. Explain the spin wave and magnon. Find out the dispersion relation for ferromagnetic materials.
4. Define antiferromagnetism and give the molecular field theory of antiferromagnetism.
5. Explain spin orientations of ferrimagnetic materials. Give the molecular field theory of antiferromagnetism.

UNIT 14

SUPERCONDUCTIVITY

Structure:

- 14.1 Introduction
- 14.2 Objective
- 14.3 Discovery of superconductivity and observations
- 14.4 Destruction of superconductivity by magnetic field
- 14.5 Meissner Effect
- 14.6 Types of superconductors
- 14.7 Thermodynamic properties of superconductor
 - 14.7.1 Entropy
 - 14.7.2 Thermal Conductivity
 - 14.7.3 Isotopic effect
 - 14.7.4 Heat Capacity
 - 14.7.5 Energy gap
- 14.8 London Equation
 - 14.8.1 London penetration depth
 - 14.8.2 Coherence length
- 14.9 BCS Theory
- 14.10 Flux quantization
- 14.11 Single particle tunnelling
- 14.12 Josephson Tunneling effect
 - 14.12.1 DC Josephson effect
 - 14.12.2 AC Josephson effect
- 14.13 High Temperature superconductors
- 14.14 Applications
- 14.15 Summary
- 14.16 Glossary
- 14.17 References
- 14.18 Suggested reading
- 14.19 Terminal Questions

14.1 INTRODUCTION

When certain materials or alloys are cooled to sufficiently low temperatures (say beyond the critical temperature T_c), the electrical resistivity of many material and alloys suddenly drop to zero. This critical temperature is of the range of temperature of liquid helium. Such materials and alloys are termed as superconductors and this phenomenon is called superconductivity. The zero resistance of the material leads to the maximum conduction in the material. Thus, it is named as superconductors. At critical temperature T_c , a phase transition is observed in the specimen from normal conducting state to superconducting state.

In superconducting state, the dc resistivity of a superconducting specimen is zero or very close to zero thus the electric current in a superconducting loop can flow for many years without any attenuation. The variation of the superconducting behaviour of superconductor and metals (pure or impure) is shown in Fig.14.1.

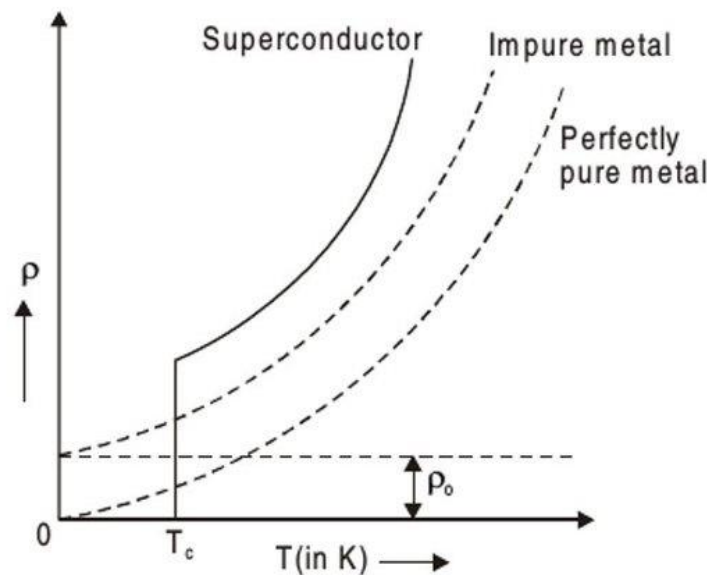

Figure 14.1 Variation of resistance of a metal and a superconductor with temperature.

Following are some important features of superconductivity:

- The crystal structure did not get altered during transition from normal state to superconducting state. This can be proved by X-ray diffraction. This also validates that the superconductivity is a phenomenon related to free electrons and not the atoms.
- The photoelectric properties did not change.
- Thermal expansion and elastic properties remained unchanged.
- Latent heat and volume remain unchanged.

- During the phase transition, the magnetic flux is fully ejected out of the material and it behaves as a perfect diamagnetic material.
- If the field equal to critical field H_c is applied to the material, it loses its superconductivity.
- Specific heat shows exponential change with temperature.

14.2 OBJECTIVE

After studying this unit, we should be able to understand-

- Superconductivity
- Critical field and critical temperature
- Meissner Effect
- Thermodynamic properties of superconductor
- London Equation
- London Penetration depth
- Coherence length
- BCS Theory
- Flux quantization
- Josephson Tunneling effect

14.3 DISCOVERY OF SUPERCONDUCTIVITY AND OBSERVATIONS

In 1908, Kamerlingh Onnes was first liquidify the helium. He used an ingenious apparatus to cool helium and converts it in liquid form. This liquid helium and its properties were studied. Based on this theory, cooling of different substances and framing their properties at low temperatures was also done. Later, this theory became base for the generating of the new theory of superconductors. In 1911, Kamerlingh Onnes observed that the electrical resistance of mercury dropped abruptly and completely disappeared at temperatures a few degrees above the absolute zero, and named this phenomenon as superconductivity. Kamerlingh demonstrated the superconducting phases for 25 elements. Many alloys and intermetallic compounds have also been shown to be superconductors. A few of them are mentioned in Table 1.

Table 1: Some elements and compounds show superconductivity

Element	T_c (K)	Compound	T_c (K)
Niobium	9.46	Nb_3Ge	23.2
Lead	7.18	Nb_3Ga	20.3
Mercury	4.15	Nb_3Sn	18.05
Indium	3.41	NbN	16
Aluminium	1.19	Mo_3Lr	8.8

Cadmium	0.56	PdSb ₂	1/25
Titanium	0.40	AuBe	2.64
Iridium	0.14	AuSb ₂	0.58
Tungsten	0.01	ZrAl ₂	0.30

In case of the superconductors, the resistance decreases with the decrease in temperature and when the metal became a superconductor the resistivity abruptly drops to 0 at T_c . This temperature is termed the critical temperature. As predicted by Cohen, superconductivity had been observed in semiconductor crystals with large free electron densities. There is a possibility of every pure element showing superconducting behaviour below critical temperature, though it may take a long time for the transition to occur. The monovalent alkali and noble metals had been investigated to less than 0.1K without showing any evidence of superconductivity. Superconductivity is also absent in the ferromagnetic metals, and it is well known that magnetic impurities have a deleterious effect on superconductivity in their host solid. This is easy to reconcile with the startling magnetic behaviour of a superconductor.

14.4 DESTRUCTION OF SUPERCONDUCTIVITY BY MAGNETIC FIELD

In 1913, Kammerlingh observed that superconductivity is destroyed if sufficient strong magnetic field is applied. In other words, we can say that the electrical resistivity of any material remains unaltered or restored due to the presence of a strong magnetic field. The externally applied magnetic field necessary to destroy the superconductivity of any material is called the critical magnetic field $H_c(T)$. $H_c(T)$ is the function of temperature and is expressed by the equation given as:

$$H_c(T) = H_c(0) \left[1 - \left(\frac{T}{T_c} \right)^2 \right] \quad (1)$$

Where $H_c(0)$ is the critical magnetic field at absolute zero.

This expression is often called Tuyn's law. The relation between critical field and temperature is shown in figure 14.2 which is result of this expression. It shows the phase boundary between the superconducting and normal state.

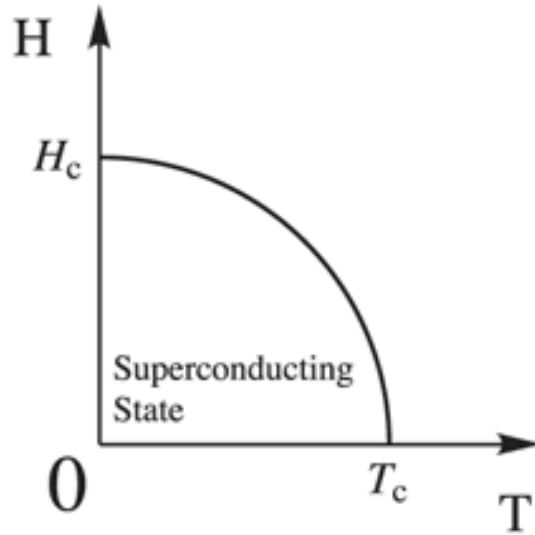

Figure 14.2 Variation of critical magnetic field with temperature.

14.5 MEISSNER EFFECT

In 1933, Meissner and Ochsenfeld found that if a superconductor is cooled in a magnetic field below the transition temperature, the magnetic field lines are pushed out from the bulk superconductor. They named this phenomenon “Meissner effect”. In other words, the bulk superconductor behaves as the inside of superconductor $B = 0$. The relatively weak magnetic fields are entirely repulsed from the interior of superconductors. The Fig 14.3 shows the behaviour of magnetic field lines when a superconductor is placed in magnetic field.

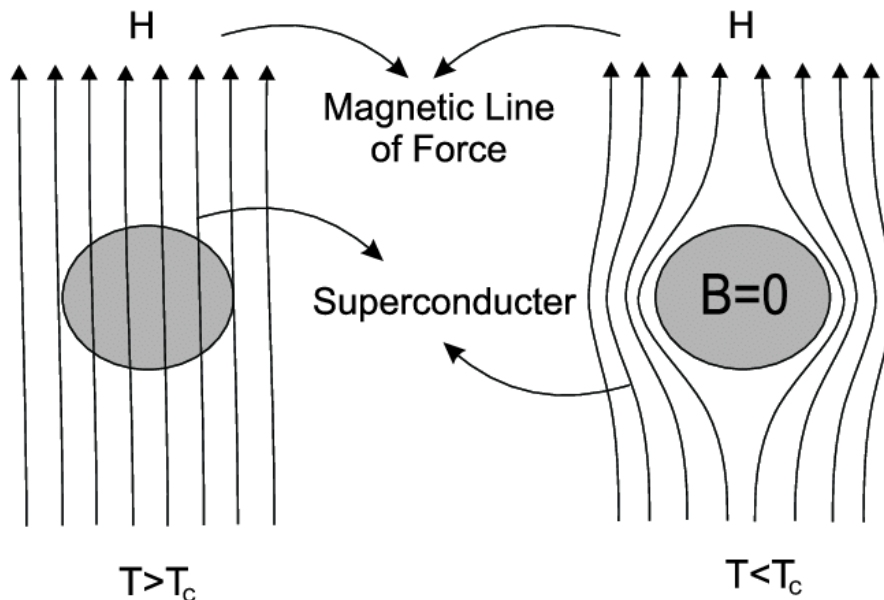

Figure 3 Meissner effect in Superconductors.

The Meissner effect can be understood by assuming that the destruction of magnetic field inside the bulk superconductor is due to an electric current flowing inside the material, which produces

a magnetic field which cancel the applied magnetic field. Thus the net magnetic field inside the superconducting material is zero as

$$B = 0 \quad (2)$$

$$B = \mu_0(H + M) \quad (3)$$

$$H = -M$$

And, magnetic susceptibility is given as

$$\chi = \frac{M}{H} = -1 \quad (4)$$

This gives the negative magnetic susceptibility of which show the superconductivity behaves as perfect diamagnetic material.

14.6 TYPES OF SUPERCONDUCTIVITY

Superconductors have been classified as the type I and type II depending upon their behaviour in an external magnetic field, i.e., how they follow the Meissner effect.

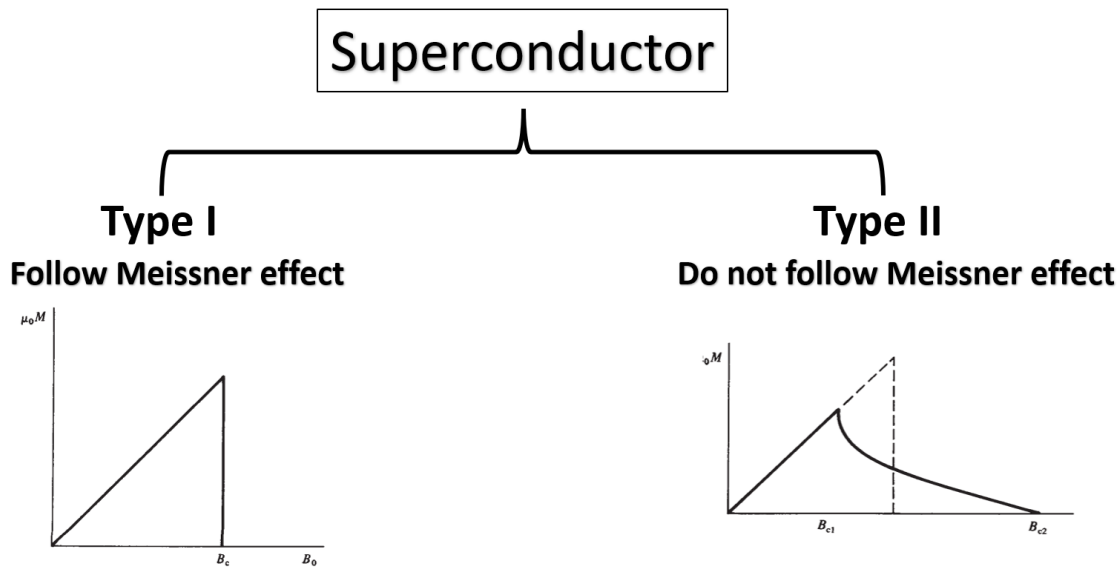

Figure 14.4 Types of superconductors and magnetization curves.

Type I superconductors:

In type I superconductor, as critical field reaches the superconductivity destroyed suddenly and entire specimen change to normal state. Figure 14.4(a) shows the magnetization curve. At critical field the magnetization suddenly becomes zero and superconductivity destroyed. Material exhibits such behavior is call type I superconductors or soft superconductor. These superconductors easily lose the superconducting state by low-intensity magnetic field. Therefore, Type-I are also known as soft superconductors. Some properties of Type I superconductors are:

- Low critical temperature (typically in the range of 0K to 10K)
- Perfectly obey the Meissner effect and magnetic field cannot penetrate inside the material.
- The transition from a superconducting state to a normal state due to the external magnetic field is sharp and abrupt for type-I superconductors.
- Type-I superconductors are generally pure metals.
- These are completely diamagnetic.
- Pure metals like Hg, Pb, Zn, etc. are few examples.

Type II superconductors have the following properties:

In type II superconductor, as critical field H_{C1} reaches the superconductivity start destroying gradually. Figure 14.4 shows the magnetization curve for Type II. There are two critical fields, at critical field H_{C1} the magnetization start decreasing and gradually becomes zero at critical field H_{C2} and superconductivity totally destroyed. The state between lower critical magnetic field H_{C1} and upper magnetic field H_{C2} is known as an intermediate state or mixed state. Material exhibits such behavior is call type II superconductors. These materials do not easily lose the superconducting state by external magnetic field thus also called as Hard Superconductors. Type-II superconductors are generally alloys and complex oxides of ceramics. These are also called as High-temperature Superconductors. The critical temperature is typically greater than 10K. Some features of type II superconductors are:

- Partly obey the Meissner effect but not completely: Magnetic field can penetrate inside the material.
- Due to the high critical magnetic field, type-II superconductors can be used for manufacturing electromagnets used for producing strong magnetic field.
- Slight impurity greatly affects the superconductivity of type-II superconductors.
- Due to the high critical magnetic field, type-II superconductors have wider technical applications.
- Compounds like Nb, Ta, Nb_3Sn , etc. are few examples.

14.7 THERMODYNAMIC PROPERTIES OF SUPERCONDUCTOR

Thermodynamic properties are defined as characteristic features of a system, capable of specifying the system's state. There are free electrons pairs present in conductors which are the reason of the conduction. In normal conductors these conduction electrons are scattered by impurities, dislocations, grain boundaries, and lattice vibrations (phonons). Unlike normal conductors there is an ordering among the conduction electrons that prevents this scattering. This ordering is named as cooper pairs. The thermodynamic parameters have direct relation with the cooper pairs. Some thermodynamic properties of superconductors are mentioned below.

14.7.1 Entropy

The disorderness and the randomness of the particles of any system is explained by the entropy of the system. The entropy of the normal conductors increases with the rise in temperature. But in case of superconductors, the entropy decreases on cooling below the critical temperature. This validates the ordering of the superconducting state. Figure 14.5 shows the variation of entropy of a normal conductor and a superconductor with temperature.

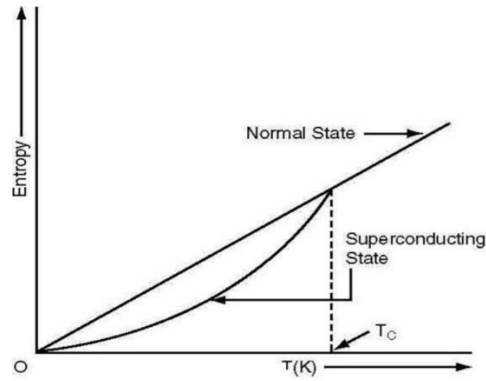

Figure 14.5: Change of entropy of normal conductor and superconductor with temperature.

14.7.2 Thermal Conductivity

Thermal conductivity accounts the level of conduction in superconductors due to the rise in temperature. A continuous change between the two phases is observed in the thermal conductivity of superconductors (Fig. 14.6). A superconductor is a perfect conductor of charge, but it cannot conduct heat. At normal temperature, electronic heat conduction of a superconductor goes to zero, as there are no thermally-excited quasiparticles to carry heat. Therefore, the superconducting electrons possibly playing no part in heat transfer.

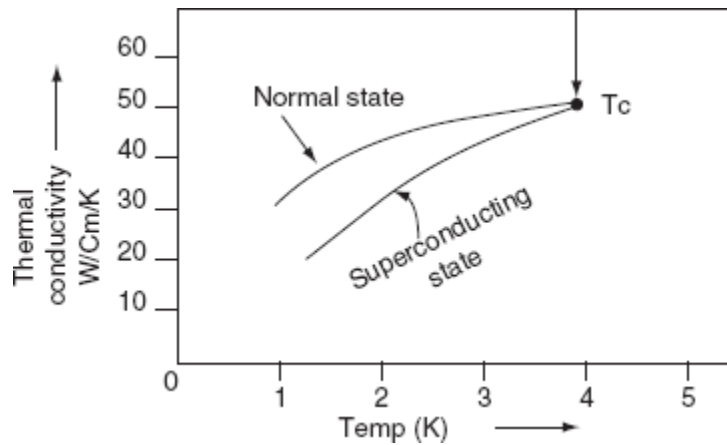

Figure 14.6: Thermal conductivity of normal conductor and a superconductor with temperature.

14.7.3 Isotopic Effect

It has been observed that the critical temperature T_c of superconductors varies with isotopic mass. The Isotope effect is one of the major properties of the superconductors. Higher T_c is found in lighter nuclei. The transition temperature T_c of superconductors found to have the dependency on the isotopic mass as

$$T_c \propto M^{-\alpha}$$

$$T_c M^\alpha = \text{constant} \tag{5}$$

Where M is atomic mass and $\alpha = 0.5$ which is valid for most of the materials. It is also observed that transition temperature changes smoothly when we mix different isotopes with same element. For example, T_c for mercury varies from 4.18 K to 4.14 K as the isotopic mass varies from 199.5 to 203.4. Isotopic mass is involved in the formation of the superconducting phase of any material.

14.7.4 Heat Capacity and Specific Heat

Electronic specific heat for superconducting materials is found to vary with temperature. Lattice specific heat variation of superconductor however remains unaltered by change in temperature (proportional to T^3). The given equation shows the variation of specific heat of superconductivity.

$$C_n(T) = AT + BT^3 \quad (6)$$

In this relation the first term is specific heat contribution due to electrons and the second term is contribution due to lattice vibration. When a small amount of heat is given to a superconductor system, some of the energy is used to increase the lattice vibrations, and the remained energy is used to increase the energy of the conduction electrons. The electronic specific heat ($C_e=AT$) of the electrons is defined as the ratio of that portion of the heat used by the electrons to the rise in temperature of the system. Superconductivity affects electrons mainly thus we assume that lattice vibration part remains same for both superconducting and normal states. The specific heat of the electrons in a superconductor varies with the absolute temperature (T_c) in the normal and in the superconducting state as shown in the Fig. 14.7.

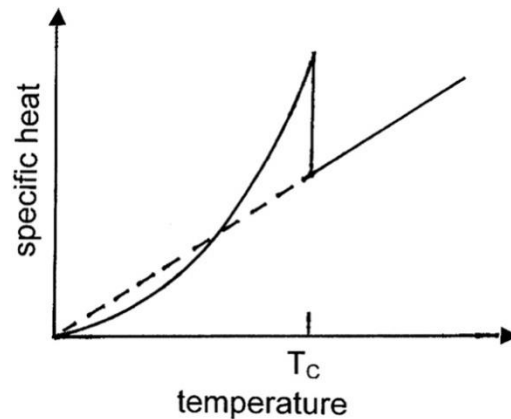

Figure 14.7: Specific Heat of normal conductor and a superconductor

14.7.5 Energy Gap

In a superconductor the important interaction is electron-electron interaction. These electrons are paired and known as cooper pair, may be considered as the single-particle of the system with zero spins. All the electrons related to the Cooper pair can be considered as the bosons. At $T=0$, all the electrons in the superconducting states are cooper pairs in the ground state. The energy can be absorbed or emitted only when the Cooper pair will break. This can be compared with the energy associated with the dissociation of atoms. The bonds of the atoms need the energy to break. Thus, the energy required to break up the Cooper pairs of the superconductors is defined as the superconducting energy gap E_g .

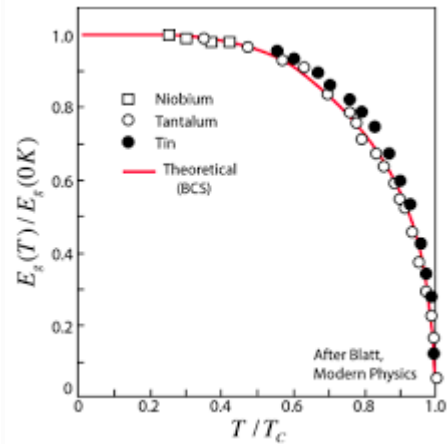

Figure 14.8: Energy gap as a function of temperature.

The energy gap in superconductor is entirely different that the nature of band gap of semiconductor. In semiconductor band gap arises due to electron lattice interaction and prevent the flow of electron. Energy needed to move the electron from valance band to conduction band. But in superconductor, this interaction ties the electron to lattice and the electrons flow in ordered way in the presence of this energy gap. The existence of energy gap can be confirmed by number of experiment and theoretically explained by BCS theory. The energy gaps of some superconductors are given in table 14.2. As temperature increases, the energy gap increases as shown in figure 14.8.

Table 14.2: Energy gaps and transition temperature of some superconductors

Elements	Energy gap $E_g(0)$ in 10^{-4}eV	T_c	$2 E_g(0)/k_T T$
Nb	3.05	9.5	3.8
Ta	1.40	4.48	3.6
Al	0.34	1.2	3.3
Sb	1.15	3.72	3.5

14.8 LONDON EQUATIONS

Maxwell equations of electromagnetism were not sufficient to explain the zero resistivity and perfect diamagnetic nature of superconductors. Following this array, F. London and M. London came up with two equations in 1934. These equations are termed as London equations and explain the Meissner effect and zero resistivity and superconductors. In superconductors, the conduction is due to the superconducting electrons. Superconducting electrons (cooper pairs) are different than free electron. As Temperature decreases, the numbers of free electrons decrease and superconducting electrons increase.

The equation of motion of superconducting electron is given as

$$m \frac{dv_s}{dt} = F = -eE \quad (7)$$

Where E is electric field. The current density is

$$J = -n_s e v_s \quad (8)$$

Where n_s is the number of superconducting electrons per unit volume and v_s is the velocity corresponding to superconducting electrons.

From derivation of eq. (8)

$$\frac{dJ}{dt} = -n_s e \frac{dv_s}{dt}$$

Put the value of $\frac{dv_s}{dt}$ from eq. (7)

$$\begin{aligned} \frac{dJ}{dt} &= -n_s e \frac{-eE}{m} \\ \frac{dJ}{dt} &= \frac{n_s e^2}{m} E \end{aligned} \quad (9)$$

This is first London equation. The superconducting electrons act like free electrons to the electric field. Taking curl of the first London equation

$$\text{curl} \frac{dJ}{dt} = \frac{n_s e^2}{m} \text{curl}(E) \quad (10)$$

Using Maxwell 3rd equation $\left\{ \text{curl} E = -\mu_0 \frac{\delta H}{\delta t} \right\}$ eq. 10 becomes

$$\text{curl} \frac{dJ}{dt} = \frac{n_s e^2}{m} \left[-\mu_0 \frac{\delta H}{\delta t} \right]$$

$$\text{curl} \frac{dJ}{dt} = \frac{-\mu_0 n_s e^2}{m} \left[\frac{\delta H}{\delta t} \right] \quad (11)$$

Integrating the above eq. (11)

$$\text{curl} J = \frac{-\mu_0 n_s e^2}{m} H - H_0 \quad (12)$$

For the Meissner effect, the field inside the material is zero, i.e., $H_0=0$. Then

$$\text{curl} J = \frac{-\mu_0 n_s e^2}{m} H \quad (13)$$

According to the Maxwell's 4th equations:

$$\text{curl} H = (J + J_D) \quad (14)$$

where J is the current density related to the material and J_D is the displacement current. If the applied external field is varying, then the J_D is very small as compared to the J value. Thus, for superconductor, Maxwell's eq. 4 can be written as above can be written as $\text{curl } H = J$
 Putting this value of J in eq. 13 we get

$$-\nabla^2 H = \frac{-\mu_0 n_s e^2}{m} H$$

$$\nabla^2 H = \frac{\mu_0 n_s e^2}{m} H \quad (15)$$

$$\nabla^2 H = \frac{1}{\lambda^2} H \quad (16)$$

$$\text{Where } \lambda^2 = \frac{m}{\mu_0 n_s e^2} \quad (17)$$

Where λ is another constant. This is known as London's second equation which explains Meissner's effect.

14.8.1 London Penetration Depth

Equation (16) is second order differential equation. The standard solution of this equation can be given as

$$H(x) = H_0 e^{-x/\lambda} \quad (18)$$

where H_0 is defined as the externally applied magnetic field and $H(x)$ is the magnetic field present inside the material at a distance x from the surface. λ is named as London penetration depth. The London penetration depth can be defined as the measure of the distance from the surface of a superconductor at which the magnetic field decays to $1/e$ of its value and the surface of the superconductor as shown in figure 14.9. The penetration depth did not remain constant and vary with temperature. At low temperature the depth remains constant but when the temperature is raised, the depth increases rapidly. When the temperature reaches its transition value, the depth approaches to infinite. The dependency of temperature on penetration depth is given by the equation

$$\lambda(x) = \frac{\lambda(0)}{\sqrt{\left[1 - \left(\frac{T}{T_c}\right)^4\right]}} \quad (19)$$

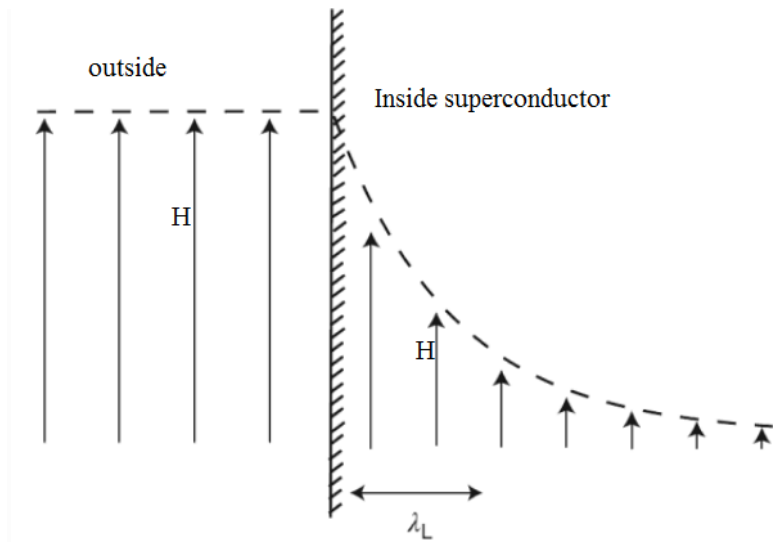

Figure 14.9: Decay of magnetic field inside a superconductor

14.8.2 Coherence Length

The coherence length is the characteristic exponent of the variations of the density of superconducting component. In eq. (18) the x component in the exponent term is coherence length. The average distance between the two electrons in a Cooper pair is known as the coherence length. It is represented by ξ . The coherence length depends upon the particular superconducting material.

14.9 BCS THEORY

BCS theory gave a satisfactory explanation for the Superconductivity of the material. In 1957 Bardeen, Cooper, and Schrieffer (BCS) gave an explanation for the superconductor based on the formation of cooper pairs. In normal state the force between the electrons is observed to be repulsive. Superconductors the force between two electrons becomes attractive due to the formation of the Cooper pairs. The BCS theory postulated that the electrons present inside the superconductor experience a special kind of neutral attraction. This attraction dominates over the coulombic repulsion and results in the formation of cooper pairs at very low temperature. Cooper pairs move within the lattice without scattering and result in the transition of material from normal conductor to superconductor. BCS theory has very wide range of applicability as for He, Type I, Type II and high temperature superconductors. It is assumed that there is a BCS wave function composed of particle pairs $k \uparrow$ and $k \downarrow$. The BCS theory can be understood with the help of following accomplishments.

(1) Attractive interaction of electrons:

An attractive interaction among the electrons in a superconductor results a ground state separation from excited state by energy gap E_g . The critical field thermal properties are due to this energy gap.

(2) Electron – Lattice – Electron Interaction

The electron pair experiences an attractive force. The ion core undergoes a slight displacement due to the attractive force. This displacement is termed as **lattice distortion**. Similar thing happens with the nearby electrons which ever came in the field of this attractive force. This process is known as **Electron–Lattice–Electron Interaction**. Any two electrons can interact via lattice distortions. The interaction leads to the subsequent reduction of energy of the electron. Thus, the interactions between electrons give results in attractive forces.

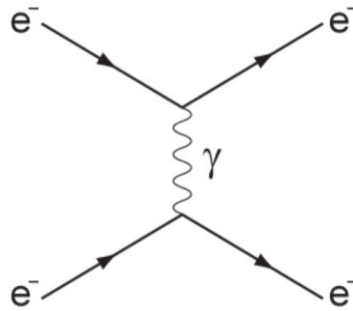

Figure 14.10: Electron – Lattice – Electron Interaction due to phonon field.

(3) Cooper Pair

The lattice distortions result in the generation of momentum of lattice which leads to the generation of phonons. These phonons interact to give free electrons called cooper pairs. Thus, Cooper pairs are the pair of free electrons formed by the interaction between the electrons in the phonon field. The cooper pairs do not experience any scattering and flow with zero resistance.

(4) Penetration depth and coherence length:

The penetration depth and coherence length are the natural consequences of BCS theory. If we go in detail, we will find the explanation of out the results as penetration depth and coherence length Meissner effect.

(5) Transition temperature:

The transition temperature depends on the density of state $D(\epsilon_F)$ and lattice interaction energy. BCS theory predicts that

$$T_C = 1.14\theta \exp[-1/U D(\epsilon_F)] \quad (20)$$

Where θ is Debye temperature and U is attractive interaction energy.

(6) Magnetic Flux quantization:

The magnetic flux through a superconducting loop is quantised in terms of $2e$ in place of e . The superconducting state contains electron pair thus the charge is quantised in term of $2e$.

14.10 FLUX QUANTIZATION IN SUPERCONDUCTING RING

We can prove that the flux that pass through a superconducting ring is quantized and flux associated to the ring of any superconducting body is an integral multiple of $\left(\frac{h}{e^*}\right)$ where $e^*=2e$ is

the charge associated to the superconductor. The circulation of electrons within the circumference of superconductor leads to the phase coherence. Therefore, the line integral of the phase around the inner circumference must be an integral multiple of 2π .

$$\int \vec{k} \cdot d\vec{l} = 2\pi n \quad (21)$$

Where k is phase vector l is circular path. The momentum of superconducting electron can be given as

$$\hbar k = m^* v_s + e^* A \quad (22)$$

where mass of superconducting electrons is represented by m^* and A is the vector potential.

From the definition of current density $J_s = -n_s e^* v_s$ or $v_s = \frac{J_s}{n_s e^*}$

Putting the value in equations (22) we have

$$\hbar k = \frac{m^* J_s}{e^* n_s} + e^* A \quad (23)$$

In wave vector form
$$\vec{k} = \frac{m^* \vec{J}_s}{\hbar e^* n_s} + \frac{e^* \vec{A}}{\hbar} \quad (24 a)$$

Put the value of wave vector from eq. (24 a) in eq. (21)

$$\int \vec{k} \cdot d\vec{l} = \left(\frac{m^*}{\hbar e^* n_s} \right) \oint \vec{J}_s \cdot d\vec{l} + \frac{e^*}{\hbar} \oint \vec{A} \cdot d\vec{l} = 2\pi n \quad (24 b)$$

Beyond the penetration depth, the line integral J_s will be zero. Hence eq.24 becomes

$$\oint \vec{A} \cdot d\vec{l} = 2\pi \frac{\hbar n}{e^*} \quad (25)$$

Using Stokes theorem, this eq.25 can be given as

$$\oint \text{curl } \vec{A} \cdot d\vec{s} = \oint \vec{B} \cdot d\vec{s} = 2\pi \frac{\hbar n}{e^*}$$

we can get the magnetic flux as

$$\Phi = \oint \vec{B} \cdot d\vec{s} = n \frac{\hbar}{2e} = n \Phi_0 \quad (26)$$

Where $\Phi_0 = \frac{\hbar}{2e} = 2.07 \times 10^{-15}$ weber, is a constant called fluxon or fluxoid. The flux quantization is shown in figure 14.11. This validates that the theory of superconductivity relates with the electron pairs at the Fermi surface.

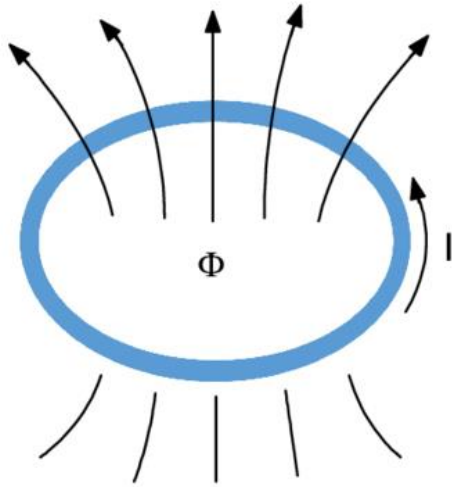

Figure 14.11: Flux quantization in a superconducting ring

14.11 SUPERCONDUCTING TUNNELLING

We have two conductors separated by a thin insulator then the insulator acts as barrier for charge flow. But if the barrier is very thin then there is a probability of charge flow. This quantum mechanical phenomenon is called tunnelling. In the year 1960, I. Giaver extended this idea and first introduced the idea of superconductive tunnelling. In his experiment he used two superconductors separated by a very thin layer of insulating material. Current passes through the junction via the process of quantum tunneling. This is also termed as superconducting tunnel junction (STJ) or superconductor–insulator–superconductor tunnel junction (SIS). Giaver did an experiment with a thin insulating oxide layer sandwiched between a normal metal and a superconductor. It was observed that the current voltage characteristics change from the straight line to curve as shown in figure 14.12.

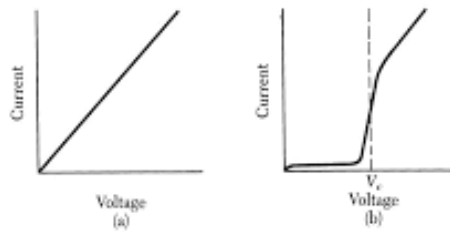

Figure 14.12: (a) Current voltage relation in normal conductor separated by an insulator (b) superconductor and a conductor separated by an oxide layer insulator

In superconductor there is an energy gap centered at Fermi level. At absolute zero temperature there is no flow of electron until a potential, equal to energy gap is applied. This is minimum energy for excited state. The existence of energy gap and the requirement of conservation of

energy, any single particle current to flow until a voltage (ϕ) is applied and the condition is given as

$$\phi = E_g/2e \quad (27)$$

For the above equation, for $e\phi < E_g$, the flow of current is restricted to tunneling by the thermally excited particles. For $e\phi > E_g$ secondary tunnelling came into work destroying the cooper pairs and sharp increase in current occurs. At $T > 0$ the discontinuity becomes less prominence and discontinuity observed in current-voltage characteristics.

14.12 JOSEPHSON TUNNELING EFFECT

In 1962, Brian Josephson postulated that the superconducting electron pairs (Cooper pairs) could tunnel through a thin insulating barrier kept in between two superconducting electrodes. Josephson observed some remarkable effects due to tunneling of superconducting electrons through a very thin insulator sandwiched between two superconductors. Such an insulating layer forms a weak link between the superconductors which is referred to Josephson junction. Josephson effect is two types:

1. DC Josephson effect
2. AC Josephson effect

14.12.1 DC Josephson Effect

The Cooper pairs in the two superconductors develop a correlation and there is tunnelling of these Cooper pairs through the barriers and a current flow across the junction in absence of any voltage. This phenomena of quantum mechanical tunneling of Cooper pairs between two superconductors separated by a thin insulating barrier is termed as DC Josephson effect. In 1962, Josephson predicted that if two superconducting metals are placed next to each other separated by a thin insulated oxide coating, then a current would flow in the absence of any voltage. This effect is indeed observed because if the barrier is not too thick then electron pairs can cross the junction from one superconductor to the other without dissociating. The superconducting wave function of the electron of both side of junction must have a definite phase difference θ .

The superconducting current flowing across the junction is given by the expression:

$$J = J_0 \sin \theta = J_0 \sin[\theta_2 - \theta_1]$$

Where J_0 is critical current i.e. maximum current that can be sustained by the junction and $\theta = (\theta_2 - \theta_1)$ is quantum mechanical phase difference.

14.12.2 AC Josephson Effect

If a dc voltage is applied across such a junction, it produces a small alternating current (ac), this effect is known as AC Josephson effect. These two properties are of great interest to the electronics and computer industries where they can be exploited for fast-switching purposes. The phase

difference associated to AC Josephson effect can be derived from Schrodinger equation. When a voltage is applied through the junction, the phase difference changes as:

$$\frac{d\theta}{dt} = \frac{2e\phi_0}{\hbar}$$

Where ϕ_0 is applied voltage. Now the phase variation can be given as

$$\theta(t) = \theta_0 - \frac{2e\phi_0}{\hbar} t$$

And current is given as

$$J = J_0 \sin \theta(t) = J_0 \sin \left[\theta_0 - \frac{2e\phi_0}{\hbar} t \right]$$

The current oscillation frequency is $\omega = \frac{2e\phi_0}{\hbar}$. This is called AC Josephson effect.

14.13 HIGH TEMPERATURE SUPERCONDUCTORS

High temperature superconductors (HTS) are mainly oxides with high transition temperature and critical field. The discovery of high temperature superconductors had given new field of research in superconducting materials. The chemical bonding and physical properties at high temperature vary from low transition temperature. A minor hindrance in the oxygen atoms and cations doping converts the material into low carrier density metal first and then into the superconducting one. Some high temperature oxide superconductors are:

BaPb _{0.75} Bi _{0.25} O ₃	(BPBO)	T _C = 12K
La _{1.85} Ba _{0.15} CuO ₄	LBCO)	T _C = 36K
YBa ₂ Cu ₃ O ₇	(YBCO)	T _C = 12K
Tl _{0.75} Ba ₂ Ca ₂ Cu ₃ O ₁₀	(TBCO)	T _C = 120K

The high temperature oxide semiconductors can have the following properties:

- They are derived from ideal perovskite composition ABX_3 here A is larger cation, B is smaller cation, and X is anion.
- Copper is present in the mixed valance state involving a partial oxidation of Cu^{2+} into Cu^{3+} .
- There is a charge transfer to and from CuO_2 layer which is induced by doping near the metal-insulator phase boundary existing in all oxide high temperature superconductors.
- The crystal structures of all these are highly anisotropic. The bonding in these materials is highly directional and covalent.

- The coherence length and the penetration depth are also highly anisotropic.
- The lower critical field H_{c1} , and upper field H_{c2} are highly anisotropic.

14.14 APPLICATIONS

In practical and applied physics, superconductors have wide applicability. A few of them are mentioned below:

- Power transmission:** Electrical power transmission through any conductor is always accompanied by energy loss I^2R . If superconductors are used for power transmission, the losses will be eliminated and the power transmission can be done at a lower voltage level with much higher efficiency.
- Superconducting magnets:** An Electromagnet is made by using superconducting wire is called a superconducting magnet. The advantage of such wires or cables is that once the current is set up the coil requires no source of electromotive force to derive the current. Superconducting magnets are used in Magnetic resonance imaging(MRI) employed to generate images of bodies. This technique has very less harmful and can be used over X-rays.
- Electrical applications in cryotron:** Cryotron consists of a wire of superconducting material A around which another wire of superconducting material B is bound in the form of a solenoid. The cryotron Based on the principle of activity above the critical temperature. At 4.4 K temperature, both A and B materials are in the superconducting state. Cryotron has wide applications in fast-acting switches.
- Very strong magnetic fields:** The strong magnetic field is of the order of 50 Tesla by consuming only 10 KV can be generated with the poles made of superconducting material. Such coils are cost-effective than the regular conventional electromagnets. High magnetic fields are required in many areas of research and in pharmaceutical science.
- Superconducting quantum interference devices:** Superconducting Quantum interference devices (SQUID) are fundamentally superconducting rings that act as storage devices for magnetic flux they are used to detect very minute changes in the magnetic field of a human brain or body or any other part.
- In computer technology:** Due to heat generated (loss I^2R), there is a limit to which the components can be crowded on a chip of given size. The use of superconductors in makes it possible to assemble more circuit in the given area of the chip.

14.15 SUMMARY

1. When certain materials or alloys are cooled to sufficiently low temperatures (say beyond the critical temperature T_c), the electrical resistivity of many material and alloys suddenly drop to zero. Such materials and alloys are termed as superconductors and this phenomenon is called superconductivity.

2. Kammerlingh observed that superconductivity is destroyed if sufficient strong magnetic field is applied. The externally applied magnetic field necessary to destroy the superconductivity of any material is called the critical magnetic field $H_C(T)$ is the function of temperature.

$$H_C(T) = H_C(0) \left[1 - \left(\frac{T}{T_C} \right)^2 \right]$$

3. Meissner and Ochsenfeld found that if a superconductor is cooled in a magnetic field below the transition temperature, the magnetic field lines are pushed out from the bulk superconductor. They named this phenomenon “Meissner effect”.

4. The transition temperature T_C of superconductors found to have the dependency on the isotopic mass as

$$T_C M^\alpha = \text{constant}$$

5. The specific heat of superconductivity

$$C_n(T) = AT + BT^3$$

6. This is first London equation

$$\frac{dJ}{dt} = \frac{n_s e^2}{m} E$$

Second London equation

$$\nabla^2 H = \frac{1}{\lambda^2} H \quad \text{where } \lambda^2 = \frac{m}{\mu_0 n_s e^2}$$

7. London penetration depth

$$H(x) = H_0 e^{-x/\lambda}$$

$$\lambda(x) = \frac{\lambda(0)}{\sqrt{\left[1 - \left(\frac{T}{T_c} \right)^4 \right]}}$$

8. Flux quantization:

$$\Phi = \oint \vec{B} \cdot d\vec{s} = n \frac{h}{2e} = n \Phi_0$$

where $\Phi_0 = \frac{h}{2e} = 2.07 \times 10^{-15}$ weber, is a constant called fluxon or fluxoid.

9. Superconducting current flowing across the junction:

$$J = J_0 \sin \theta = J_0 \sin[\theta_2 - \theta_1]$$

Where J_0 is critical current i.e. maximum current that can be sustained by the junction and $\theta = (\theta_2 - \theta_1)$ is quantum mechanical phase difference.

10. AC Josephson effect

$$J = J_0 \sin \theta(t) = J_0 \sin \left[\theta_0 - \frac{2e\phi_0}{\hbar} t \right]$$

The current oscillation frequency is $\omega = \frac{2e\phi_0}{\hbar}$.

14.16 GLOSSARY

Superconductivity: Zero resistance ability.

Critical: Involving a deep analysis.

Hard superconductor: These materials do not easily lose the superconducting state by external magnetic field.

Soft superconductor: These superconductors easily lose the superconducting state by low-intensity magnetic field.

14.17 REFERENCES

- i. C. Kittel (1996) Introduction to solid state physics. Seventh edition. John Wiley & sons, New York.
- ii. H. C. Gupta (2013) Solid State physics. Second revised edition. Vikas publishing house Pvt. Ltd., New Delhi.
- iii. S. L. Gupta, V. Kumar (2017) Elementary Solid-State physics. First edition. Pragati prakashan, Meerut.
- iv. H. P. Myers, (2009) Introductory Solid-State Physics. Second edition. Taylor & Francis Ltd., USA.
- v. R. K. Puri, V. K. Babbar (2009) Solid State Physics. Third edition. S. Chand & Company Ltd, New Delhi.

14.18 SUGGESTED READINGS

- i. S. H. Simon (2013) The Oxford Solid State Basics. Oxford University Press, UK.
- ii. S. O. Pillai, S. Pillai (2007) Rudiments of Material Science. Second edition. New Age International Pvt. Ltd., New Delhi.
- iii. AJ Dekker, Solid state Physics, Macmillan, London
- iv. HE Hall, Solid state Physics, Wiley, USA
- v. F Seitz. Modern theory of Solid, McGraw Hill, USA
- vi. JM Ziman, Principle of the theory of Solids, Cambridge, Britain
- vii. WA Harrison, Solid state theory, McGraw Hill, USA

14.19 TERMINAL QUESTIONS

Short answer type questions:

- Q1. At what temperature is $H_c(T) = 0.1 H_c(0)$ for Lead having T_c equals to 7.2K?
- Q2. Why do superconductors expel magnetic fields?
- Q3. Is plasma a superconductor?
- Q4. Prove that the value of magnetic susceptibility for diamagnetic materials is -1.
- Q5. Do all superconductors expel magnetic flux?
- Q6. For the energy gap of $10.97 \times 10^{-4} \text{eV}$, determine the value of the bias voltage for the tunnelling current to flow (ϕ).
- Q7. What happens to the magnetic field when a superconductor is placed in a weak external magnetic field H , and cooled below its transition temperature?
- Q8. Describe the physical meaning of the coherence length (ξ) in superconductors.

Long answer type questions:

- Q1. What is Type 1 and Type 2 superconductors? Mention important differences.
- Q2. Explain the occurrence of superconductivity.
- Q3. Explain and derive the London equations.
- Q4. Explain Josephson effect in detail.
- Q5. Why do various superconductors have different T_c ?
- Q6. The critical temperature of mercury is 4.153 K for its one isotope of mass 200.59 amu. Calculate the critical temperature of Mercury for its one isotope of mass 200 amu.

Answers:

Short Answer – 1. 6.83K, **7.** $21.94 \times 10^{-23} \text{V}$

Long Answer–4. 0.0126Wb m^{-2} ,